

REGISTRATION NUMBER

PURCHASING AUTHORITY NUMBER
 (if applicable)

AGREEMENT NUMBER

1. This Agreement is entered into between the Contracting Agency and the Contractor named below:

CONTRACTING AGENCY NAME

CONTRACTOR NAME

2. The term of this Agreement is: Start Date:

End Date:

3. The maximum amount of this Agreement is: \$

4. The parties agree to comply with the terms and conditions of the following exhibits which are by this reference made a part of the Agreement:

EXH	TITLE	PAGES

Signature on File

Items shown with an asterisk () are hereby incorporated by reference and made part of this agreement as if attached hereto. These documents can be viewed at <https://www.dgs.ca.gov/PD/Resources/Page-Content/Procurement-Division-Resources-List-Folder/Model-Contract-Language>*

IN WITNESS WHEREOF, this Agreement has been executed by the parties hereto.

CONTRACTOR		Department of Technology, Statewide Technology Procurement Use Only
CONTRACTOR NAME <i>(If other than an individual, state whether a corporation, partnership, etc.)</i>		
CONTRACTOR AUTHORIZED SIGNATURE 	DATE SIGNED	
PRINTED NAME AND TITLE OF PERSON SIGNING		
ADDRESS		
STATE OF CALIFORNIA		
CONTRACTING AGENCY NAME		<input type="checkbox"/> Exempt per_
CONTRACTING AGENCY AUTHORIZED SIGNATURE 	DATE SIGNED	
PRINTED NAME AND TITLE OF PERSON SIGNING		
CONTRACTING AGENCY ADDRESS		

EXHIBIT A, STATEMENT OF WORK

1 BACKGROUND AND PURPOSE

The Governor's Office of Emergency Services (Cal OES), Public Safety Communications, CA 9-1-1 Emergency Communications Branch (CA 9-1-1 Branch) is authorized by statute Government Code (GC) Sections 53100-53121 to manage and oversee the statewide 9-1-1 emergency communications system. The authority to oversee the expenditures of State Emergency Telephone Number Account (SETNA) funds is provided in the California Department of Finance's Manual of State Funds, 0022. The CA 9-1-1 Branch is responsible for administering the SETNA which provides funding to California Public Safety Answering Points (PSAPs) for 9-1-1 systems and services. Guidance for filing 9-1-1 tariffs is provided by the California Public Utilities Commission (CPUC) and can be found at:

http://www.cpuc.ca.gov/uploadedFiles/CPUC_Public_Website/Content/Utilities_and_Industries/Communications_-_Telecommunications_and_Broadband/Service_Provider_Information/911%20Tariff%20Filing%20Text%20for%20CD.pdf

The Next Generation 9-1-1(NG9-1-1) services in California will follow the National Emergency Number Association (NENA) i3 Call Flow per Figure 1 in NENA-STA-010.2-2016 https://cdn.ymaws.com/www.nena.org/resource/resmgr/standards/NENA-STA-010.2_i3_Architectu.pdf NENA Detailed Functional and Interface Standards for the NENA i3 Solution. Each region shall provide NENA i3 call flow to support interoperability between their Region and the Prime. The Prime shall have the overall management and direction for consistency of call flow, as defined in the SOW and EXHIBIT 21 – TECHNICAL REQUIREMENTS.

The Prime Network Service Provider (PNSP) and Regional Network Service Provider (RNSP) shall provide services that meet National Emergency Number Association (NENA) Next Generation 9-1-1 (NG9-1-1) requirements and standards available upon contract award, and as they become available in the future within 6 months of CA 9-1-1 Branch notification of any future updates to the NENA i3 standard, at no additional cost to the CA 9-1-1 Branch. Contractor shall provide an annual compliance report stating how they meet all applicable standards.

Additional resource documents for the (PNSP) to reference:

- CA 9-1-1 Branch Operations Manual <http://www.caloes.ca.gov/cal-oes-divisions/public-safety-communications/ca-9-1-1-emergency-communications-branch>

- Federal Communications Commission (FCC) best practices:

<https://www.fcc.gov/best-practices>

The general 9-1-1 traffic flow will be to aggregate 9-1-1 traffic in each region. The RNSP shall aggregate, process and deliver all 9-1-1 traffic from AT&T, Consolidated Communications wireline and Frontier wireline, and all wireless Originating Service Providers (OSPs) to the correct PSAP.

The PNSP shall aggregate, process and deliver all small Local Exchange Carriers (LECs), Voice over Internet Protocol OSPs (VoIP OSPs) and Text to 9-1-1 traffic to the correct PSAP. The PNSP shall also deliver 9-1-1 traffic from RNSP to the correct PSAP in the event the RNSP cannot deliver the 9-1-1 traffic for any reason.

The 9-1-1 traffic will be anchored at aggregation until verification of the ability for the regional NG9-1-1 core services to deliver the 9-1-1 traffic. In the event that the regional NG9-1-1 Core Services cannot deliver the 9-1-1 traffic, the 9-1-1 traffic will be passed to the Prime NG9-1-1 Core Services for routing and delivery to the PSAP by the PNSP. The assumption is that all 9-1-1 traffic that arrives at PNSP aggregation will be delivered by the PNSP under normal conditions and all 9-1-1 traffic that arrives at the RNSP aggregation will be delivered by the RNSP under normal conditions. In the event 9-1-1 traffic is passed to a region that should be delivered by another region, the region will pass the 9-1-1 traffic to the PNSP for routing and delivery to the PSAP. In the event 9-1-1 traffic cannot be delivered to a PSAP by the PNSP, the PNSP shall pass the 9-1-1 traffic to the correct RNSP to deliver to the PSAP.

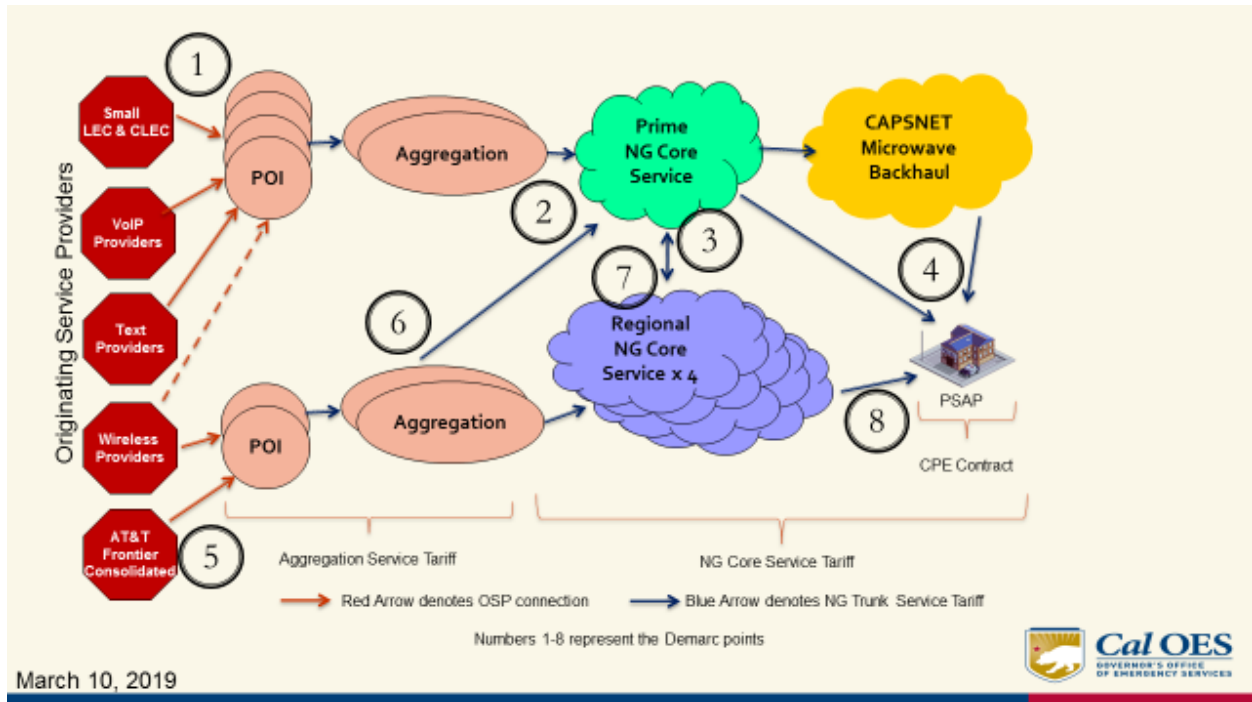

FIGURE 1: NEXT GENERATION 9-1-1 TARIFF SCHEME

Demarc number	Prime Network Service Provider Demarc description
1	Small LEC, Text, and VoIP OSPs
2	Aggregation to Prime NGCS
3	From Prime NGCS to Regional NGCS (will require demarc for each RNSP)
4	Prime NGCS to all PSAP statewide
Demarc number	Regional Network Service Provider Demarc description
5	All Wireless OSPs, Consolidated Communications, AT&T, and Frontier
6	From Regional aggregation to Prime NGCS (will require demarc from each RNSP to Prime NGCS)
7	From Regional NGCS to Prime NGCS (will require demarc from each RNSP to Prime NGCS)
8	From Regional NGCS to PSAP within region

The Warren 9-1-1 Emergency Assistance Act, Government Code 53100-53120 modified in 2015 by Senate Bill SB1211, requires the Cal OES, CA 9-1-1 Branch to implement Next Generation 9-1-1 (NG9-1-1) including Text to 9-1-1 in California. With the increased use of text by the general public, Text to 9-1-1 will provide an immediate and crucial method beyond existing video relay, 7-1-1 relay, and IP relay to allow the deaf, disabled and hard of hearing community to receive emergency service when needed and provide an alternate method for those without speech or with hearing disabilities to contact 9-1-1.

The FCC, through agreement with the four (4) major wireless carriers (AT&T, Sprint, T-Mobile and Verizon) agreed to make Text to 9-1-1 services available in May 2014. Other wireless carriers were required to make text available by January 2015.

Since 2014, California has proactively participated in trials to accommodate the FCC agreement with wireless carriers to provide Text to 9-1-1 services to meet California's emergency response needs.

The CA 9-1-1 Branch currently has a Text to 9-1-1 Services contract in place that will expire April 2020. As of January, 219 there are 286 PSAPs currently have deployed or are in the process of deploying Text to 9-1-1 Services, 244 are web based text and 42 are integrated into the PSAP's Customer Premise Equipment (CPE). A transition from the existing Contract shall take as soon as possible after contract execution and based on the Project Deployment Plan (PDP).

1.1 OBJECTIVE

This Statement of Work (SOW) shall be the Contract between the CA 9-1-1 Branch and the Contractor to provide the Prime NG9-1-1 Services that will connect to every PSAPs in California and that will interconnect the four (4) Regions. All Prime NG9-1-1 services shall be purchased off of Tariffs. The Contractor shall provide service to process 9-1-1 traffic, which shall include voice and data to the appropriate PSAPs.

This SOW shall also be the Contract between the CA 9-1-1 Branch and the Contractor to provide the Regional NG9-1-1 Services that will connect to every PSAP in a specific Region in California. All Region NG9-1-1 services shall be purchased off of Tariffs. The Contractor shall provide service to process 9-1-1 traffic, which includes voice and data, to the appropriate PSAPs in the awarded region. Throughout this SOW a distinction will be made when SOW requirements apply only to a Region or to the Prime. When not delineated or where there may be ambiguity, the requirements apply to both a Region and the Prime.

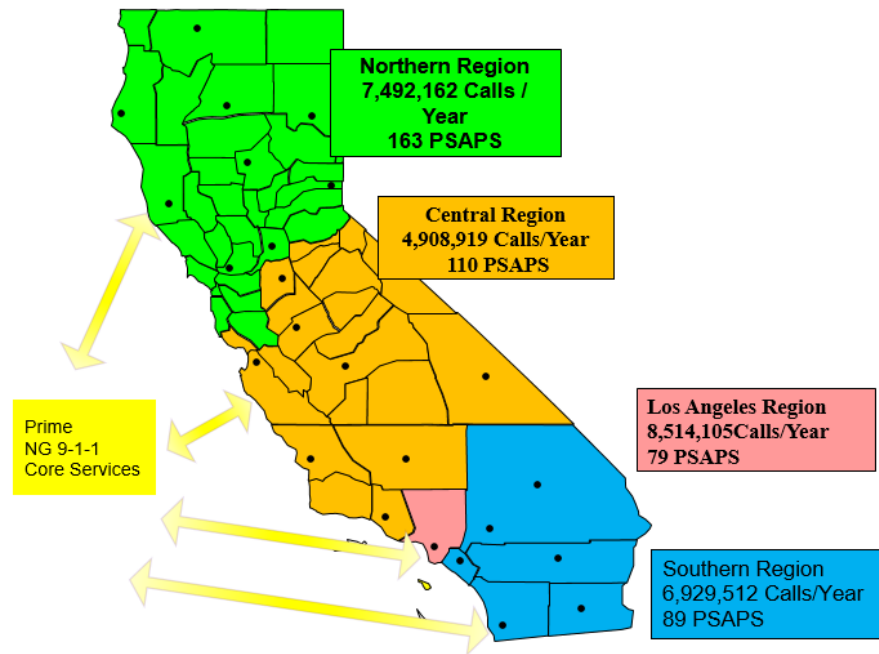

FIGURE 1.1 NEXT GENERATION PRIME JURISDICTION MAP

The Text to 9-1-1 service shall be available to all (approximately 440) primary and secondary PSAPs in California and accommodate every PSAP deployment method. Any Text to 9-1-1 sessions shall be available by Web Browser, Integrated, and Prime NG Core Services to a PSAP that integrate with a Host-Remote Configuration, or Stand Alone environment.

The Prime Contractor shall provide NG9-1-1 Prime Network Services which will include a connection to every PSAPs in California to deliver NG Text to 9-1-1 Services. All NG Text to 9-1-1 Services shall be purchased off of Tariffs. The Prime Contractor shall provide service to deliver Text to 9-1-1 traffic to the PSAPs. The PNSP shall be responsible for all costs associated with the network connectivity to the Text Control Center (TCC), PSAPs, and future connections. The PNSP shall not charge a connection fee for any connectivity. The PNSP shall provide system monitoring for the NG9-1-1 Trunks and all 9-1-1 traffic from aggregation to PSAP.

2 DESCRIPTION OF PROPOSED NEW SERVICE

2.1 SERVICE TO BE PROVIDED

The Prime Contractor agrees to provide Prime NG9-1-1 services in accordance with the SOW and EXHIBIT 21, TECHNICAL REQUIREMENTS. The Region Contractor agrees to provide Region NG9-1-1 services for the awarded region in accordance with the SOW and EXHIBIT 23, TECHNICAL REQUIREMENTS. The contractor agrees to standards based,

non-proprietary Prime NG9-1-1 services or Region NG9-1-1 services to be provided but not limited to:

- 1) PNSP shall manage and maintain CA 9-1-1 Statewide Geographic Information System (GIS) database;
- 2) RNSP shall integrate with the CA 9-1-1 Statewide GIS database;
- 3) PNSP shall provide Statewide network performance monitoring and oversight and provide access through dashboard that includes data pushed from RNSP to PNSP;
- 4) RNSP shall provide Regional network performance monitoring and oversight and provide access through dashboard and push data to the PNSP for statewide network monitoring;
- 5) PNSP shall provide network monitoring for all four (4) regional networks, using data provided by the RNSPs, in addition to the Prime Network and provide access through dashboard, per EXHIBIT 21: PRIME TECHNICAL REQUIREMENTS and EXHIBIT 23: REGION TECHNICAL REQUIREMENTS;
- 6) PNSP shall be solely responsible for trouble ticket reporting for all services in the Prime network to include subcontractor services. The PNSP shall develop and maintain trouble ticket e-bonding for all PNSP and RNSP trouble ticketing;
- 7) RNSP shall be solely responsible for trouble ticket reporting for all services in the awarded Region network to include subcontractor services. The RNSP shall support trouble ticket e-bonding from PNSP for trouble ticket reporting;
- 8) Prime shall interpret and implement standards and best practices with CA 9-1-1 Branch concurrence to be used by all Regions for consistency of 9-1-1 traffic between aggregation services, the Regions and Prime and established connectivity standards at each PSAP to ensure global interoperability;
- 9) RNSP shall implement standards and best practices as determined by the Prime with CA 9-1-1 Branch concurrence to be used by the awarded Region for consistency of 9-1-1 traffic between aggregation services, the Regions and Prime and established connectivity standards at each PSAP to ensure global interoperability;
- 10) PNSP shall manage, process and deliver NG Text to 9-1-1 services for the State. For the approximate 440 PSAPs in California, the PSAPs currently deployed with Text services shall be transitioned first to use this Contract, unless otherwise specified by CA 9-1-1 Branch. Wherever possible the integrated text service shall be deployed, based upon the PSAP's CPE and their readiness; otherwise, the default mode for Web based text services shall be used;
- 11) PNSP shall provide redundancy to support failover for each Region in the state;
- 12) RNSP shall provide redundancy to support failover for the Prime for the PSAPs in the awarded Region in the state;

- 13) PSNP shall provide aggregation and 9-1-1 traffic routing for all Voice over Internet Protocol (VoIP) and small LEC OSPs in California. This excludes wireless, AT&T wireline, and Frontier wireline and Consolidated Communications wireline;
- 14) RNSP shall provide aggregation and 9-1-1 traffic routing for all wireless, AT&T wireline, and Frontier wireline, and Consolidated Communications wireline OSP in California for the awarded Region;
- 15) PNSP shall provide leadership to promote collaborative mission focused, implementation that supports interoperability and Cal OES mission;
- 16) The RNSP shall follow the leadership provided by the PNSP to promote collaborative mission focused, implementation that supports interoperability and Cal OES mission;
- 17) The PNSP, RNSP and the CA 9-1-1 Branch shall provide a lead team member to work together to establish the interoperability interface. The PNSP Team Member shall be the Interface Team Leader. The Interface Team shall meet at a minimum weekly to develop the interoperable capability of the NG9-1-1 networks and interfaces;
- 18) PNSP and RNSP shall provide CPUC approved tariffed services based on the SOW and approval of the CA 9-1-1 Branch;
- 19) The PNSP shall be responsible to support integration of an NG9-1-1 Emergency Alert and Warning System (NG9-1-1 AWS) to include capabilities to use all functions provided by the Federal Emergency Management Agency (FEMA) Integrated Public Alert and Warning System (IPAWS).

2.2 PROJECT DESIGN

The NG9-1-1 service provider shall be responsible for providing NG9-1-1 tariffed services as defined by this SOW, and EXHIBIT 21, PRIME TECHNICAL REQUIREMENTS, and EXHIBIT 23, REGION TECHNICAL REQUIREMENTS.

The six (6) areas of tariffed services are:

- 1) NG9-1-1 Trunk Services;
- 2) NG9-1-1 Prime Aggregation Services (Note: Provide aggregation and 9-1-1 traffic routing for all VoIP and small LEC originating service providers in California. This excludes wireless, AT&T wireline, and Frontier wireline, and Consolidated Communications wireline);
- 3) NG9-1-1 Region Aggregation Services (Note: Provide aggregation and 9-1-1 traffic routing for all wireless, AT&T wireline, and Frontier wireline, and Consolidated Communications wireline OSPs in the awarded Region in California.
- 4) NG9-1-1 Core Services;
- 5) NG9-1-1 Prime Functions and Services;
- 6) NG9-1-1 Region Functions and Services.

2.3 NG9-1-1 SERVICES ENVIRONMENT

This section is intended to present an overview of the NG9-1-1 Services Environment. The PNSP shall be responsible to deliver a solution utilizing the required technical requirements identified in the SOW and EXHIBIT 21, PRIME TECHNICAL REQUIREMENTS. The RNSP shall be responsible to deliver a solution utilizing the required technical requirements identified in the SOW and EXHIBIT 23, REGION TECHNICAL REQUIREMENTS.

The NG9-1-1 Services – Prime and Region in California shall follow the NENA i3 Call Flow per NENA-STA-010.2-2016, NENA Detailed Functional and Interface Standards for the NENA i3 Solution. Each region shall provide NENA i3 call flow to support interoperability between their Region and the Prime. The Prime shall have the overall management and direction for consistency of call flow.

The NG9-1-1 Service Network Provider – PNSP shall be responsible to aggregate all OSP 9-1-1 traffic with the exception of AT&T, Frontier, Consolidated Communications wireline and wireless OSP. Text to 9-1-1 is also included as part of the 9-1-1 traffic. The PNSP shall aggregate all Text to 9-1-1 traffic from the Text Control Center or OSP. The PNSP shall be responsible for routing all aggregated 9-1-1 traffic to the appropriate PSAP. In the event of a regional network failure, the PNSP shall be responsible to provide redundant path for routing all 9-1-1 traffic from region through Prime to the PSAP. In the event a PSAP requires 9-1-1 traffic to be transferred outside of their region, the PNSP shall be responsible to accept the 9-1-1 traffic from the RNSP and deliver to the appropriate PSAP.

The NG9-1-1 Regional Network Service Provider – (RNSP) shall be responsible to aggregate all AT&T, Frontier, Consolidated Communications wireline and wireless OSP traffic within their awarded region.

The PNSP and RNSP shall be responsible to anchor all 9-1-1 traffic at aggregation until verification of the ability for the NG9-1-1 core services to deliver the call to the appropriate PSAP.

The RNSP shall be responsible for all costs associated with the network connectivity to the PNSP for the redundant connectivity. The PNSP shall not charge the RNSP a connection fee for the redundant connectivity.

2.4 COMMERCIALY AVAILABLE HARDWARE

Where ever possible, commercially available hardware shall be used for the best quality and ability to replace parts quickly for maintenance and/or upgrades.

3 TERM OF THE CONTRACT

Effective upon approval of the California Department of Technology (CDT), Statewide Technology Procurement (STP), the term of the contract is five (5) years with five (5) one (1) year optional extensions.

The CA 9-1-1 Branch at its sole discretion, may exercise its option to execute, five (5), one (1)-year extensions to perform Prime NG9-1-1 Core Services , ongoing support, and

knowledge transfer at the rates identified in EXHIBIT 22, COST WORKBOOK, for a maximum contract term of ten (10) years.

The CA 9-1-1 Branch may also amend to add services, including those identified as RNSP services, at the rates provided in the Contractor's BAFO submission.

3.1 CONTRACT COMMENCEMENT TIME

Upon contract execution, the Contractor shall not be authorized to deliver or commence the performance of services as described in this SOW until written approval has been obtained from Cal OES. Any delivery or performance of service that is commenced prior to the signing of the contract shall be considered voluntary on the part of the Contractor and non-compensable.

Upon contract execution, the Contractor shall align the deployment NG Text to 9-1-1 Services as identified in the SOW, Project Deployment Plan (PDP), and EXHIBIT 21: TECHNICAL REQUIREMENTS. All other NG9-1-1 Services shall not be started until approval and written notification by Cal OES. All NG9-1-1 Services are expected to commence upon funding approval.

Contractor shall update tariffs and obtain CPUC approval of the tariff filing within 120 days of contract execution that support all technical requirements in EXHIBIT 21 or 23, cost elements in EXHIBIT 22 and the requirements in the SOW to CPUC and shall comply with all regulatory requirements. Failure to obtain approved tariff from the CPUC shall result be a material breach of contract.

3.2 CONTRACT AMENDMENTS

This Contract may be amended, consistent with the terms and conditions of the Contract and by mutual consent, of both parties, subject to approval by the STP.

3.3 GENERAL PROVISION DEFINITIONS

For this contract only the following sections of the GSPD 401 IT General Provisions are further defined as listed below:

22.a)

"Notice of Termination" means the written notice specifying the date and Services to be terminated, which shall be no later than 90 days after the date the notice was issued.

26.a)

For the purposes of Section 26a of the General Provisions limited liability, purchase price will be defined as the State's aggregate Not to Exceed (NTE) contract amount for the previous twelve months prior to the incident (\$10,358,400) or the Contractor's aggregate contract amount, whichever is lower.

4 CONTRACT CONTACTS

The project representatives during the term of this Contract will be:

The CA 9-1-1 Branch contact will be the primary interface with the Contractor.

State: Governor’s Office of Emergency Services, Public Safety Communications, CA 9-1-1 Branch Name: Tiffany Howard Address : 601 Sequoia Pacific Blvd. Sacramento, CA 95811 Phone: (916) 657-9233 e-mail: Tiffany.Howard@caloes.ca.gov	Contractor: NGA 911, LLC Name: Don Ferguson Address: 8383 Wilshire Blvd, Suite 800 Beverly Hills, CA 90211 Phone: (213)284-1480 e-mail: Don@nga911.com
--	--

5 SOLUTION REQUIREMENTS

5.1 TECHNICAL REQUIREMENTS

All requirements as stated in EXHIBIT 21, PRIME TECHNICAL REQUIREMENTS and EXHIBIT 23, REGION TECHNICAL REQUIREMENTS, are part of this SOW. Within ten (10) days of award of contract, the Contractor shall schedule an initial meeting with the CA 9-1-1 Branch to prioritize the statewide deployment. The services shall meet the technical requirements contained in all worksheets in EXHIBIT 21, PRIME TECHNICAL REQUIREMENTS and EXHIBIT 23, REGION TECHNICAL REQUIREMENTS. Additional meetings may be required to further prioritize the statewide deployment. Additional meetings shall be agreed upon by the Contractor and CA 9-1-1 Branch at the initial meeting. The priorities to the statewide deployment shall be used to establish the Deployment Plan identified in section 13.1. The CA 9-1-1 Branch shall reserve the right to reassign priorities for the deployment of the statewide network. The Contractor agrees to follow the priorities as assigned by CA 9-1-1 Branch.

The Deployment Plan for Prime NG9-1-1 services at 440 PSAPs will require the Contractor to assign A Single Point of Contact to prioritize the statewide rollout in an efficient manner and consider all dependencies of PSAPs, Technology, CA 9-1-1 Branch Timeframe, Ordering Process, Risks, Training, Resources, and Acceptance Testing.

The Deployment Plan for an awarded Region NG9-1-1 services at all PSAPs in the awarded Region will require the Contractor to assign a Single Point of Contact to prioritize the region wide rollout in an efficient manner and consider all dependencies of PSAPs, Technology, CA 9-1-1 Branch Timeframe, Ordering Process, Risks, Training, Resources, and Acceptance Testing.

6 CONTRACTOR FACILITY LOCATIONS

All Contractor's facilities, direct technical and administrative support personnel that will perform services as part of this Contract must be located within the Continental United States (CONUS) or the District of Columbia. The PNSP and RNSP shall maintain a minimum of two (2) geographically diverse cores dedicated to California with demonstrated capability to provide 99.999% availability.

7 CA 9-1-1 BRANCH ROLES AND RESPONSIBILITIES

- 1) The CA 9-1-1 Branch will designate a person to whom all Contractor communication may be addressed, and who has the authority to act on all aspects of the services, see Section 4 for designee. This person will review the SOW and associated documents with the Contractor to ensure understanding of the responsibilities of both parties;
- 2) The CA 9-1-1 Branch personnel shall utilize the Project Milestone Report (PMR), SOW – ATTACHMENT 8, to document and track the status of all project tasks. The original PMR will be maintained with the CA 9-1-1 Branch and a copy of the PMR will be provided to the PNSP and RNSP Contractor.
- 3) The CA 9-1-1 Branch will provide access to department staff and management, offices and operation areas, as required, to complete the tasks and activities defined under this Contract;
- 4) The CA 9-1-1 Branch requires a minimum of ten (10) State business days for the review and approval of information and documentation provided by the Contractor to perform its obligations. In the event CA 9-1-1 Branch is unable to review and approve documents within the ten (10) days, the Contractor will be notified of the adjusted date. The documents are not automatically approved in the event CA 9-1-1 Branch is not able to review and approve within the ten (10) business days. If the Contractor is not provided an estimated date of State review and approval completion, the Contractor may initiate the escalation process which is identified in Section 11, Problem Escalation;
- 4) If a Contractor employee is unable to perform due to illness, resignation, or other factors beyond the Contractor's control, the Contractor will provide suitable substitute personnel. The substitute personnel shall be interviewed and approved by the CA 9-1-1 Branch NG9-1-1 Manager.
- 5) The CA 9-1-1 Branch will work with PSAP in the event there is no cabling available at Main Point of Entry (MPOE). For these instances, PNSP and RNSP shall not be responsible for any cost element related to new cabling and installation.

8 CONTRACTOR'S ROLES AND RESPONSIBILITIES

- 1) Upon contract execution the PNSP and RNSP shall meet via in person meeting or teleconference, with the CA 9-1-1 Branch team at a minimum weekly, or at the discretion of the CA 9-1-1 Branch, to ensure project tasks and timelines are met, with all Contractor Key Staff identified in SOW Section 9. The CA 9-1-1 Branch may require an in person meeting based on project status.
- 2) Upon contract execution until NG9-1-1 services are fully implemented, the PNSP and RNSP Project Coordinator shall maintain communication with the CA 9-1-1 Branch team on a regular basis throughout the week.
- 3) Once NG9-1-1 services are fully implemented, the PNSP and RNSP team shall meet with the CA 9-1-1 Branch at a minimum monthly to review outage reports and SLAs. This meeting will be in person with the CA 9-1-1 Branch team.
- 4) The PNSP shall develop all interface standards for aggregation, region, and PSAP, based on direction and approval from the CA 9-1-1 Branch.
- 5) The RNSP shall comply with all PNSP developed interface standards for aggregation, region, and PSAP, based on direction and approval from the CA 9-1-1 Branch.
- 6) The PNSP and RNSP shall collaborate on the implementation and development of all interface standards based on direction and approval from the CA 9-1-1 Branch. Upon contract execution the CA 9-1-1 Branch will establish a regular meeting schedule to facilitate PNSP and RNSP collaboration.
- 7) The Contractor shall provide its own equipment and software necessary to perform the required duties;
- 8) The PNSP and RNSP shall use a multi-layered redundancy of systems, software and facilities with no single point of failure;
- 9) The Contractor shall designate a primary contact person to whom all project communications may be addressed and who has the authority to act on all aspects of the services;
- 10) The Contractor shall notify CA 9-1-1 Branch in writing, of all changes in key personnel assigned to the tasks as outlined in Section #9 below. If a Contractor employee is unable to perform due to illness, resignation, or other factors beyond the Contractor's control, the Contractor will provide suitable substitute personnel. The substitute personnel shall be interviewed and approved by the CA 9-1-1 Branch NG9-1-1 Manager;
- 11) The Contractor shall perform their duties on the premises of the PSAP facilities located within California during the best available hours for the PSAP and at all other times as required to successfully provide the services;
- 12) Contractor staff that perform duties on premises of the PSAP will be subject to that PSAP's background check and security requirements;

- 13) The Contractor shall maintain a Certificate of Public Convenience and Necessity (CPCN) through CPUC throughout the term of the contract;
- 14) The Contractor shall have CPUC approved tariffs that match the contract terms, conditions, and pricing, throughout the term of the contract.
- 15) The Contractor shall submit a Project Milestone Report (PMR) for each non-tariffed NRC. Prior to payment, CA 9-1-1 Branch acceptance and signature of PMR is required.

9 CONTRACTOR KEY STAFF

The Contractor will be responsible for providing all necessary staff to implement all services within the Prime NG9-1-1 Services Contract.

Unanticipated Tasks will be charged at the hourly rates identified in the Cost Workbook (EXHIBIT 22). Pricing for this tariffed line item shall be provided in the EXHIBIT 22, COST WORKBOOK. Within 14 calendar days of contract execution, the Contractor shall submit in writing to CA 9-1-1 Branch the following key staff:

- 1) Project Coordinator;
 - a) A minimum of three (3) years' experience with knowledge and experience in managing projects/ system installations of similar complexity.
- 2) PNSP Alert and Warning Coordinator;
 - a) A minimum of two (2) years' experience with Knowledge and experience in emergency notification systems, alert and warning requirements, and FEMA Integrated Public Alert Warning System (IPAWS).
- 3) NG9-1-1 Trunk Services Coordinator;
 - a) A minimum of two (2) years' experience with knowledge and experience in NG9-1-1 networks.
- 4) NG9-1-1 Aggregation Services Coordinator;
 - a) A minimum of two (2) years' experience with knowledge and experience in NG9-1-1 traffic aggregation and network configuration.
 - b) A minimum of two (2) years' experience with knowledge and experience working with the OSP include wireless, wireline, and VoIP technologies.
- 5) NG9-1-1 Core Services Coordinator;
 - a) A minimum of two (2) years' experience with knowledge and experience in development and implementation of NG9-1-1 Core Services.

- 6) NG9-1-1 Prime or Region Functions and Services Coordinator;
 - a) A minimum of two (2) years' experience with knowledge and experience in development and implementation of NG9-1-1 Core Services including network interoperability, system monitoring, GIS, and outage reporting.
- 7) PNSP Text-to-9-1-1 Coordinator;
 - a) A minimum of two (2) years' experience with knowledge and experience in NG Text to 9-1-1 Services.
- 8) System Monitoring and Outage Reporting Coordinator.
 - a) A minimum of two (2) years' experience with knowledge and experience in system monitoring, outage reporting, NG9-1-1 Network Services.

The proposed Key Staff must be available to start work on the project within 30 days of Contract execution.

10 SUBCONTRACTORS

The PNSP and RNSP Contractor shall provide and maintain a list of all subcontractors providing the services identified below. The information shall be submitted in the same format as EXHIBIT 24: LIST OF PROPOSED SUBCONTRACTORS.

- Next Generation Core Services (NGCS)
- GIS
- Emergency Call Routing Function (ECRF)
- Emergency Services Routing Proxy (ESRP)
- Location Information Service (LIS)
- Location Database (LDB)
- Aggregation
- Alert and Warning
- Text-to-9-1-1
- System Monitoring

The PNSP and RNSP Contractor notify the CA 9-1-1 Branch, in writing, of any changes of Subcontractor personnel assigned to the tasks within ten (10) business days of the change. CA 9-1-1 Branch retains the right to approve or not approve. This requirement does not apply to subcontractors providing supplies only and no labor to the overall contract or project.

11 PROBLEM ESCALATION

The parties acknowledge and agree that certain technical and project related problems or issues may arise, and that such matters shall be brought to the CA 9-1-1 Branch's attention. Problems or issues shall be reported in monthly status reports and via web-based alerting/monitoring systems accessible by the CA 9-1-1 Branch. Severity of the problem(s) as outlined below require escalated reporting. To this extent, the Contractor will determine the level of severity and notify the appropriate CA 9-1-1 Branch personnel. The CA 9-1-1 Branch personnel notified, and the time period taken to report the problem or issue, shall be at a level commensurate with the severity of the problem or issue. The CA 9-1-1 Branch personnel include, but are not limited to, the following:

First level: NG9-1-1 Manager
First.Last@caloes.ca.gov
(916) 657-####

Second level: Ryan Sunahara, Division Chief
Ryan.Sunahara@caloes.ca.gov
(916) 657-9100

Third level: Budge Currier, Branch Manager
Budge.Currier@caloes.ca.gov
(916) 657-9911

11.1 SERVICE ISSUES AND OUTAGE NOTIFICATION

After Contract award, information for the confidential CA 9-1-1 Branch outage notification phone number and e-mail will be provided. The outage reporting shall incorporate real-time or live monitoring per EXHIBIT 21 PRIME TECHNICAL REQUIREMENTS or EXHIBIT 23 REGION TECHNICAL REQUIREMENTS, where a secure log in portal is available to CA 9-1-1 Branch.

The Contractor shall develop an automated outage notification system that will provide live system monitoring capability and outage reporting to the CA 9-1-1 Branch.

11.1.1 FAILURE EVENT NOTIFICATION

In the event of any service issue(s) and/or outage(s) as specified in the appropriate Service Level Agreement (SLA), the Contractor shall notify the CA 9-1-1 Branch via a phone call and via email within ten (10) minutes of initial report of outage or network failure, providing the Initial Notification and containing the following (as available):

- 1) Primary outage location;
- 2) Problem description;
- 3) Time of failure;
- 4) Affected systems/services;
- 5) Impact to the provision of 9-1-1 Service;
- 6) Trouble ticket number; Ticket pending (test or dispatch).

Follow-up notifications shall be provided by the contractor as new information becomes available or every 2 hours, whichever occurs first, and include a current status of the data provided in the initial contact and any additional data pertinent to the outage and its resolution such as:

- 1) Extent of outage;
- 2) Affected systems/services (if different than initial);
- 3) Potential number of requests for emergency services denied/failed, if unable to determine if requests for emergency service were lost or not, "session lost – unknown" should be in the outage notification);
- 4) Sequence of events toward resolution (action taken to resolve the issue);
- 5) Estimated time of technician arrival (ETA)/Estimated time of outage resolution (ETR).

When major event is cleared, Contractor shall send a Final Notification of resolution. CA 9-1-1 Branch may review this with the Contractor every month, to determine if major notifications need to be adjusted to support the overall Cal OES situational awareness. See SLA Section 32.

11.1.2 OTHER EVENT NOTIFICATION

For any other service issue(s) or outage(s) that the monitoring system does not report on, the Contractor shall notify CA 9-1-1 Branch. Notifications shall include but are not limited to location not delivered with 9-1-1 traffic from OSP, 80% trunk capacity, policy based routing failure, and regional network down. Contractor shall notify the CA 9-1-1 Branch of the problem via e-mail within five (5) minutes of initial report of outage or disruption of service(s) providing the Initial Notification and contain the following (as available):

- 1) Primary outage location;
- 2) Problem description;
- 3) Time of failure;
- 4) Affected systems/services;
- 5) Impact to the provision of 9-1-1 Service;
- 6) Trouble ticket number; Ticket pending (test or dispatch).

When other event is cleared, Contractor shall send a Final Notification of resolution. CA 9-1-1 Branch may review this with the Contractor every month, to determine if notifications need to be adjusted to support the overall Cal OES situational awareness. See SLA Section 32.

11.1.3 OUTAGE REPORTING

The Contractor shall for any service/system outage, deliver the appropriate e-mail, and if necessary a voice call to the CA 9-1-1 Branch Outage phone, and provide root cause analysis. See SLA Section 32

12 CHANGE CONTROL PROCESS

The Contractor shall not make any changes after implementation and successful acceptance of the NG9-1-1 service, unless approved by the CA 9-1-1 Branch NG9-1-1 Manager. If change is required after implementation and successful acceptance that adds time or money, the amendment process shall be followed.

13 CONTRACTOR TASKS AND DELIVERABLE REQUIREMENTS

13.1 MAINTENANCE PLAN

Contractor shall be responsible for all maintenance to the Prime NG9-1-1 Services and the Region NG9-1-1 Services for the term of the Contract, at no additional cost. PNSP and RNSP Contractor shall include a draft maintenance plan in response to the RFP. A final maintenance plan shall be submitted to CA 9-1-1 Branch for review and approval within 90 days from Contract execution. Planned or unplanned maintenance shall not disrupt 9-1-1 service and/or trigger any SLAs.

Maintenance Schedule shall include at a minimum:

- 1) Hardware Issues;
- 2) Servers;
- 3) Switches;

- 4) Routers;
- 5) Software Issues;
- 6) Operating System Software Issues;
- 7) Security System Software Issues;
- 8) Connectivity Issues.

13.2 PNSP PROJECT DEPLOYMENT PLAN (PDP)

All documents shall be provided in electronic format unless a hardcopy is specifically requested by the State.

- 1) The PNSP Contractor shall submit a draft Statewide NG9-1-1 PDP as a part of their bid submission. Upon contract execution, PNSP Contractor shall submit a final statewide PDP within 60 days after contract execution or a mutually agreed upon date between the Contractor and CA 9-1-1 Branch per the SLA 32.2. All modifications to the PNSP final PDP shall be approved by CA 9-1-1 Branch. The PDP shall be a task-oriented Gantt chart detailing the deployment activities, clearly identifying all external dependencies outside of the Contractor's control for expected timelines and that addresses each of the NG9-1-1 service areas.
- 2) The PNSP Contractor shall utilize the Project Milestone Report (PMR), SOW – ATTACHMENT 8, for each milestone to document and track the status of all project tasks. The original PMR will be maintained with the CA 9-1-1 Branch and a copy of the PMR will be provided to the PNSP.
- 3) Within 60 days of contract execution for each Region, the PNSP and RNSP Project Managers shall begin coordination of their Interface and Integration Plan of the PDP's for all associated tasks for connectivity between PNSP and RNSP, PSAP interface, and aggregation per the SLA 32.2. The PNSP and RNSP who fail to meet this requirement shall collectively be subject to the SLA 32.2. CA 9-1-1 Branch will schedule and facilitate meetings between PNSP and RNSP within 60 days of contract execution for each region.
- 4) Within 120 days of contract execution for each Region, the PNSP and RNSP Project Managers shall complete coordination of their Interface and Integration Plan of the PDP's for all associated tasks for connectivity between PNSP and RNSP, PSAP interface, and aggregation per the SLA 32.2. The PNSP and RNSP who fail to meet this requirement shall collectively be subject to the SLA 32.2. CA 9-1-1 Branch will schedule and facilitate meetings between PNSP and RNSP within 60 days of contract execution for each region. The PDP shall include major milestones identified at a minimum the following:

1. Identify Key Staff
2. Project schedule with major milestones identified
 - a) PSAP site survey schedule;
 - b) Network requirements and final design solution;
 - c) OSP aggregation connectivity plan;
 - d) PNSP Text to-911 deployment plan;
 - e) PNSP Alert and Warning deployment plan;
 - f) PNSP Alert and Warning training plan;
 - g) Acceptance Test Plan;
 - h) Training plan;
 - i) Monthly Billing and SLA plan;
 - j) PSAP cutover day plan;
 - k) Interface and Integration plan (shall include PSAP, RNSP and aggregation);
 - l) Selective Router Decommissioning Plan: This plan will outline the PNSP role in transitioning all 9-1-1 traffic from selective router.
- 5) PNSP Contractor shall conduct a site survey;
- 6) PNSP Contractor shall deliver a certificate of system readiness when the service is ready for acceptance testing;
- 7) PNSP Contractor shall develop the Statewide Text to 9-1-1 Project Deployment Plan as part of the master Project Plan within ten (10) days after contract execution or a mutually agreed upon date. The Deployment shall consist of at least three (3) phases with milestones that are completed for PSAPs with Text Existing within three (3) month, PSAPs with Text Planned within six (6) months, and PSAPs remaining within nine (9) months. The project plan shall be a task-oriented Gantt chart detailing the deployment activities, clearly identifying all external dependencies outside of the Contractor's control for expected timelines;
- 8) PNSP Contractor shall deliver System Acceptance Testing to ensure that the system operates in substantial accord with the technical specifications, is

adequate to perform as warranted by Contractor's response to the requirements of this Contract and evidences a satisfactory level of performance reliability, prior to its acceptance;

- 9) PNSP Contractor shall deliver acceptance testing for software (other than Operating System Software);
- 10) PNSP Contractor shall provide a Project Coordinator with knowledge and experience in managing system installations of similar complexity at no additional cost to the PSAP or the CA 9-1-1 Branch. All installations shall use industry accepted project management methodology throughout the project;
- 11) PNSP Contractor shall deliver maintenance service including parts, software support and labor;
- 12) PNSP Contractor shall deliver notification to the PSAPs if determining telephone line repair is needed;
- 13) PNSP Contractor shall deliver the necessary maintenance and parts to keep the service in good operating condition, which includes preventative scheduled maintenance.

13.3 RNSP PROJECT DEPLOYMENT PLAN

All documents shall be provided in electronic format unless a hardcopy is specifically requested by the State.

- 1) The RNSP Contractor shall submit a draft Region-wide NG9-1-1 Project Deployment Plan as a part of their bid submission. Upon contract execution, RNSP Contractor shall submit a final statewide PDP within 60 days after contract execution or a mutually agreed upon date between the Contractor and CA 9-1-1 Branch per the SLA 32.2. All modifications to the RNSP PDP shall be approved by CA 9-1-1 Branch. The PDP shall be a task-oriented Gantt chart detailing the deployment activities, clearly identifying all external dependencies outside of the Contractor's control for expected timelines and that addresses each of the NG9-1-1 service areas.
- 2) The RNSP Contractor shall utilize the Project Milestone Report (PMR), SOW – ATTACHMENT 8, for each milestone to document and track the status of all project tasks. The original PMR will be maintained with the CA 9-1-1 Branch and a copy of the PMR will be provided to the RNSP.
- 3) Within 60 days of contract execution for awarded Region, the PNSP and RNSP Project Managers shall begin coordination of their Interface and Integration Plan of the PDP's for all associated tasks for connectivity between PNSP and RNSP, PSAP interface, and aggregation per the SLA 32.2. The PNSP and RNSP who fail to meet this requirement shall collectively be subject to the SLA 32.2. CA 9-1-1 Branch will

schedule and facilitate meetings between PNSP and RNSP within 60 days of contract execution for each region.

- 4) Within 120 days of contract execution for awarded Region, the PNSP and RNSP Project Managers shall complete coordination of their Interface and Integration Plan of the PDP's for all associated tasks for connectivity between PNSP and RNSP, PSAP interface, and aggregation per the SLA 32.2. The PNSP and RNSP who fail to meet this requirement shall collectively be subject to the SLA 32.2. CA 9-1-1 Branch will schedule and facilitate meetings between PNSP and RNSP within 60 days of contract execution for each region.
- 5) The PDP shall include major milestones identified at a minimum the following:
 1. Identify Key Staff
 2. Project schedule with major milestones identified
 - a) PSAP site survey schedule;
 - b) Network requirements and final design solution;
 - c) OSP aggregation connectivity plan;
 - d) Acceptance Test Plan;
 - e) Training plan;
 - f) Monthly Billing and SLA plan;
 - g) PSAP cutover day plan;
 - h) Interface and Integration plan (shall include PSAP, RNSP and aggregation);
 - i) Selective Router Decommissioning Plan: This plan will outline the RNSP role in transitioning all 9-1-1 traffic from selective router.
 - 6) RNSP Contractor shall conduct a site survey;
 - 7) RNSP Contractor shall deliver a certificate of system readiness when the service is ready for acceptance testing;
 - 8) RNSP Contractor shall deliver System Acceptance Testing to ensure that the system operates in substantial accord with the technical specifications, is adequate to perform as warranted by Contractor's response to the requirements of this Contract and evidences a satisfactory level of performance reliability, prior to its acceptance;

- 9) RNSP Contractor shall deliver acceptance testing for software (other than Operating System Software);
- 10) RNSP Contractor shall provide a Project Coordinator with knowledge and experience in managing system installations of similar complexity at no additional cost to the PSAP or the CA 9-1-1 Branch. All installations shall use industry accepted project management methodology throughout the project;
- 11) RNSP Contractor shall deliver maintenance service including parts, software support and labor;
- 12) RNSP Contractor shall deliver notification to the PSAPs if determining telephone line repair is needed;
- 13) RNSP Contractor shall deliver the necessary maintenance and parts to keep the service in good operating condition, which includes preventative scheduled maintenance.

13.4 TEXT-TO-9-1-1 SPREADSHEET TRACKING

Due to the need to transition Text-to-9-1-1 services within 12 months of contract execution, the PNSP Contractor shall use comprehensive Excel spreadsheets depicting each PSAP, Text Service Modality, Acceptance Testing, test dates per wireless carrier, and final go live dates. This shall be provided monthly no later than the 10th calendar day of each month.

CA 9-1-1 Branch tracking #	FCCID	PSAP NAME	COUNTY	TEXT SERVICE MODALITY	STATUS	Date Approved	Carrier test date	Date for acceptance	Date Live
				Web or Integrated	Live or approved or in progress		For each carrier		

13.5 TEXT-TO-9-1-1 PSAP DEPLOYMENT PLAN

For each PSAP, the PNSP Contractor shall provide their deployment plan information 20 calendar days before the PSAP installation or a mutually agreed upon date. The deployment plan shall include, but not limited to:

- a) PSAP training;
- b) Admin training if applicable;
- c) Go Live Date;
- d) Carrier testing coordination documentation;
- e) PSAP name and contact.

13.6 TEXT-TO-9-1-1 PSAP CONNECTIVITY AND TESTING

For each PSAP, the PNSP Contractor shall, install connectivity and conduct testing as necessary.

13.7 TEXT-TO-9-1-1 PSAP ACCEPTANCE TESTING

For each PSAP, the PNSP Contractor shall coordinate with PSAP and CA 9-1-1 Branch to conduct fully comprehensive Acceptance Testing and complete the Acceptance Test Form, and submit to the CA 9-1-1 Branch. Additionally, PNSP Contractor shall perform a new Acceptance Test within five (5) business days along with any additional training if necessary, if there is a technology upgrade or if the PSAP changes from one Text-to-9-1-1 modality service to another.

14 DELIVERABLE ACCEPTANCE/REJECTION PROCESS (PNSP AND RNSP)

14.1 ACCEPTANCE

The CA 9-1-1 Branch will be the sole judge of the acceptability of all work performed and all work products produced by the Contractor as a result of this SOW. Should the work performed or the products produced by the Contractor fail to meet the CA 9-1-1 Branch conditions, requirements, specifications, guidelines, or other applicable standards, the following resolution process will be employed, except as superseded by other binding processes.

The CA 9-1-1 Branch will notify the Contractor in writing within ten (10) State business days after completion of each phase of service of any acceptance problems by identifying the specific inadequacies and/or failures in the services performed and/or the products produced by the Contractor.

The Contractor will, within five (5) State business days after initial problem notification, respond to the CA 9-1-1 Branch by submitting a detailed explanation describing precisely how the identified services and/or products actually adhere to and satisfy all applicable requirements, and/or a proposed corrective action plan to address the specific inadequacies and/or failures in the identified services and/or products. Failure by the Contractor to respond to the CA 9-1-1 Branch initial problem notification within the required time limits may result in immediate termination of the Contract.

The CA 9-1-1 Branch will, within ten (10) State business days after receipt of the Contractor's detailed explanation and/or proposed corrective action plan, notify the Contractor in writing whether it accepts or rejects the explanation and/or plan. If the CA 9-1-1 Branch rejects the explanation and/or plan, the Contractor will submit a revised corrective action plan within five (5) State business days of notification of rejection. Failure by the Contractor to respond to the CA 9-1-1 Branch' notification of rejection by submitting a revised corrective action plan within the required time limits may result in immediate termination of the Contract.

The CA 9-1-1 Branch will, within ten (10) State business days of receipt of the revised corrective action plan, notify the Contractor in writing whether it accepts or rejects the revised corrective action plan proposed by the Contractor. Rejection of the revised corrective action plan will result in immediate termination of the Contract. In the event of such termination, the CA 9-1-1 Branch shall pay all amounts due the Contractor for all work accepted prior to termination.

14.2 ACCEPTANCE TESTING CRITERIA (PNSP AND RNSP)

The Contractor shall provide Acceptance Testing Plan (ATP) and Checklist within 30 calendar days of contract execution. Contractor shall finalize ATP and Checklist and submit to CA 9-1-1 Branch for final approval within 90 calendar days of contract execution. At a minimum the ATP shall include the current NENA standards. System acceptance templates have been provided in SOW – Attachment 4a-4e and SOW – Attachment 5a-5b to identify the minimum required information.

The Contractor shall develop an ATP to include at a minimum for the following services:

- 1) NG9-1-1 Trunk Services;
- 2) PNSP NG9-1-1 Alert and Warning System;
- 3) NG9-1-1 Aggregation Services;
- 4) NG9-1-1 Statewide GIS (PNSP shall manage, RNSP shall integrate);
- 5) NG9-1-1 Core Services;
- 6) PNSP NG Text-to-9-1-1 Services and Text-to-9-1-1 Authorization Checklist;
- 7) Full System Acceptance (include Prime and Region network acceptance);
- 8) Other:
 - a) PSAP cutover plan;

- b) Billing Process;
- c) Real-Time System Monitoring;
- d) PSAP Interface;
- e) Aggregation Interface;
- f) Prime/Regional Interface.

Acceptance Testing is intended to ensure that the service is performing as warranted by Contractor's response to the requirements of this Contract and evidences a satisfactory level of performance availability as per SLAs, prior to its acceptance by the CA 9-1-1 Branch. Acceptance Testing is required for all newly installed technology service after a successful performance period.

The Contractor shall issue a certificate of system readiness to the CA 9-1-1 Branch when services are ready for Acceptance Testing. Acceptance Testing shall commence on a date and time mutually agreed upon by the CA 9-1-1 Branch, within ten (10) business days, following receipt of the certificate of system readiness and shall end when the services have met the standard of performance ATC for a period of 45 calendar days. Operation of the services to confirm proper installation shall be considered to be a part of the Acceptance Test. It is not required that the 45 calendar days expire in order to begin a subsequent Acceptance Testing period.

Services shall not be accepted by the CA 9-1-1 Branch, and no charges associated with such service shall be paid by the CA 9-1-1 Branch, until the Contractor has demonstrated that the Contractor has satisfactorily provided all of the functionality per SOW, Section 14.2 ACCEPTANCE TESTING CRITERIA.

The standard of performance for Acceptance Testing is defined as the operation of service at 99.999% availability for a period of 45 calendar days. For Acceptance Testing purposes, the system shall not have any major failures during the 45 calendar day testing period. In the event of a major failure, the 45 day clock will be restarted after the failure has been corrected. Minor failures will not restart the testing period clock however, will be noted in the System Acceptance report.

Upon successful completion of the entire NG9-1-1 network system ATC, a Certificate of System Readiness shall be completed by the PNSP, the PSAP representative and the CA 9-1-1 Branch NG9-1-1 Manager. The Certificate of System Readiness will be attached with all testing notes and findings and the original copy shall be filed with the CA 9-1-1 Branch.

It shall be in the CA 9-1-1 Branch's sole determination as to whether a deliverable service has been successfully completed and acceptable to the CA 9-1-1 Branch.

15 USER ACCEPTANCE TESTING CRITERIA (PNSP AND RNSP)

The Contractor shall coordinate with the CA 9-1-1- Branch NG9-1-1 Manager who will identify the PSAP team for User Acceptance Testing (UAT) criteria. The PSAP team will coordinate UAT with the Contractor for all NG9-1-1 Services deployed at the PSAP and Regional level. UAT will be developed by the PSAP and in collaboration with the contractor and approved by the NG9-1-1 Manager.

16 NG9-1-1 EMERGENCY ALERT AND WARNING (PNSP)

The PNSP shall be responsible for providing a statewide NG9-1-1 AWS for local, regional and state end users that meet all technical requirements outlined in EXHIBIT 21, TECHNICAL REQUIREMENTS.

The NG9-1-1 AWS shall be capable of distributing and/or broadcasting recorded voice, text-to-voice, text message, email and fax notifications to an area identified by a GIS polygon or predefined GIS tool.

16.1 PUBLIC SELF-REGISTRATION PORTAL

The PNSP shall provide a public facing portal to allow local community members to register their contact information and additional telephone, text message and email contact information that meet all technical requirements outlined in EXHIBIT 21, TECHNICAL REQUIREMENTS.

16.2 ALERT AND WARNING GIS MAP

The Alert and Warning System GIS map shall provide local, regional and state users predefined customizable geometric shapes to select contact data from the GIS map.

16.3 ALERT AND WARNING TRAINING

The PNSP shall be responsible to provide training in the form of the Train-the-Trainer course for all local, regional, and state entities who will utilize the system. Training shall include all training resource materials and on-site training per EXHIBIT 21, TECHNICAL REQUIREMENTS.

17 GEOGRAPHICAL INFORMATION SYSTEM (PNSP AND RNSP)

CA 9-1-1 Branch will provide PNSP contractor the complete and validated CA 9-1-1 Statewide GIS database that conforms to NENA-STA-010.2-2016 i3 standard and all technical requirements outlined in EXHIBIT 21, TECHNICAL REQUIREMENTS.

17.1 GEOGRAPHICAL INFORMATION DATABASE (PNSP AND RNSP)

PNSP Contractor shall be responsible for coordination and transition of Statewide GIS database from CA 9-1-1 Branch' selected GIS database Contractor. Contractor shall assimilate the Statewide GIS database and accept responsibility for the tools and resources needed to manipulate, edit, process discrepancies, provide updates, provision to functional elements, and provide data normalization of the GIS database.

RNSP Contractor shall be responsible incorporate the Statewide GIS database, emergency call routing function (ECRF), and associate policy based routing functions from CA 9-1-1 Branch' selected PNSP Contractor into the RNSP ECRF and NG Core Service solution.

17.2 GEOGRAPHICAL INFORMATION DATABASE RESPONSIBILITY (PNSP)

The Statewide GIS Database will contain the shape files and layers necessary to route 9-1-1 traffic. OSPs are responsible to provide subscriber location data and submit updates to the PNSP. The 9-1-1 County Coordinators are responsible to maintain GIS data and submit updates to the PNSP. The PNSP shall be the definitive data source for 9-1-1 traffic routing.

- 1) The PNSP shall provide an administrative access to GIS database for a maximum of 500 users. The users will include County Coordinators, OSP representatives and the CA 9-1-1 Branch. Complete list of personnel will be provided to the PNSP upon contract award;
- 2) The PNSP shall provide all PSAPs the functionality to support database location queries that integrate to CPE.

17.3 LOCATION DATABASE (LDB) AND ASSOCIATED SERVICES (PNSP)

The PNSP Contractor shall provide a Location Database (LDB) to facilitate the implementation of location services. The LDB must be able to provide Presence Information Data Format – Location Object (PIDF-LO), utilizing both the civic and geodetic profiles, for all calls entering the Next Generation Core Services (NGCS). At a minimum, the LDB shall meet the technical requirements identified in EXHIBIT 21, TECHNICAL REQUIREMENTS.

Ability for Service Providers to update their location records using their existing processes (such as Service Order Input (SOI)) or a web based user interface.

17.4 PSAP GIS BOUNDARY DATA (PNSP)

The PSNP Contractor shall maintain records of all PSAP profiles and GIS routing boundaries. The shape file jurisdiction boundaries shall be the property of the CA 9-1-1 Branch and provided upon request. The initial shape files will be provided by the CA 9-1-1 Branch; updates may be sent by County Coordinators or PSAPs and the update

process will be similar to the existing Master Street Address Guide (MSAG) update process. NG9-1-1 traffic will be routed via GIS shape files to the correct PSAP.

18 POLICY BASED ROUTING (PNSP AND RNSP)

The PNSP Contractor shall supply a rules-based routing proxy functionality per NENA-STA-010.2-2016. Specifically the Policy Routing Function (PRF) is required to interface with the Emergency Service Routing Proxy (ESRP) and the conditional routing possibilities within the NGCS. Contractors must ensure that the system's rules-based routing interfaces to the other components and functional elements making up the NGCS are in compliance with NENA-STA-010.2-2016 (https://www.nena.org/page/i3_Stage3) and meets the requirements of the CA 9-1-1 Branch. The Contractor shall specifically identify the interface used to establish these rules within the NGCS and any conditions that may exist limiting its function. All Policy Routing Data is the property of CA 9-1-1 Branch and shall be available for review by an on-line system, dashboard, by GIS, or excel data format.

The RNSP shall supply a rules-based routing proxy functionality per NENA-STA-10.2-2016 (and subsequent versions) that aligns with the PSNP developed and maintained (PRF) as required to interface with the PSNP developed and maintained Emergency Service Routing Proxy (ESRP) and the conditional routing possibilities within the NGCS.

19 DATA HANDLING AND OWNERSHIP (PNSP AND RNSP)

Contractor shall provide security for all data handling and make it available to the CA 9-1-1 Branch at no additional charge upon request in written, electronic, or by secure portal access for each of the following types of data. All data related to this contract shall be the property of the CA 9-1-1 Branch.

19.1 CALL DATA RECORDS (PNSP AND RNSP)

Any 9-1-1 Call Data Records (CDR) are the property of the CA 9-1-1 Branch and shall be available to the PSAP as defined by CA 9-1-1 Branch's Operation Manual. The Contractor shall utilize Session Internet Protocol (SIP) metadata and i3 logging to monitor, track and verify data flow as a part of the CDR. The PNSP shall be able to provide a data push and/or pull of NENA i3 logging data from all RNSPs. The RNSP shall provide a data push and/or pull of NENA i3 logging data to the PNSP. All NG9-1-1 Metadata shall have a ten (10) year retention period.

19.2 NG9-1-1 TEXT TRAFFIC STATISTICS (PNSP)

PNSP Contractor shall provide interface and all required data to support text session CDR within State's existing statistical tracking contractor. NG9-1-1 traffic includes all voice and data from caller to PSAP.

19.3 TEXT SESSION STATISTIC DATA (PNSP)

Any Text Session Data are the property of the CA 9-1-1 Branch and shall be available to the PSAP as defined by CA 9-1-1 Branch's Operation Manual. Statistical reports and Ad hoc report data shall also be available. Text Session Metadata shall be provided to CA 9-1-1 Branch for ten (10) year retention period.

19.4 TEXT SESSION DATA (PNSP)

Any Text-to-9-1-1 session data is the property of the PSAP and shall be available for up to two (2) years after the session is completed. Statistical reports and Ad hoc report data shall also be available. Batches of text session data shall be available to the PSAP by week, month, or year.

19.5 DATA MANAGEMENT (PNSP AND RNSP)

Data and reports requested within the scope of this contract shall be maintained daily and be made available electronically upon request but shall be submitted as required in the SOW.

19.6 CONFIGURATION MANAGEMENT DATABASE (PNSP AND RNSP)

The Contractor shall supply a Configuration management database that at a minimum, includes all of the software, systems, network protocols, port usage and relevant system related information in a mutually agreed upon format as defined in EXHIBIT 21 PRIME TECHNICAL REQUIREMENTS and EXHIBIT 23 – REGION TECHNICAL REQUIREMENTS.

19.7 TEST ACCEPTANCE DATA (PNSP AND RNSP)

All Test Acceptance Data shall be made available to the CA 9-1-1 Branch upon request during the deployments with no limitations for distribution and discussion. All Test Data shall be provided to the CA 9-1-1 Branch upon request, with no restrictions.

19.8 DATA TRANSFERABILITY (PNSP AND RNSP)

Upon termination or Contract expiration, for any reason, this data shall be transferred to the CA 9-1-1 Branch, in an effort to ensure emergency operations are not disrupted.

20 REPORTING (PNSP AND RNSP)

Contractor is responsible for delivering all reports as described in the SLA's, EXHIBIT 21, Prime TECHNICAL REQUIREMENTS, EXHIBIT 23, Region TECHNICAL REQUIREMENTS and SOW. In addition, the following reports are required as described below. This list is not intended to be exhaustive and additional reports may be required.

20.1 NG9-1-1 PNSP SERVICE OUTAGE REPORTING

PNSP Contractor shall provide the required outage reporting per the CA 9-1-1 Branch procedures and technical requirements EXHIBIT 21, EXHIBIT 21 PRIME TECHNICAL REQUIREMENTS.

20.2 PNSP NG9-1-1 SERVICE PROJECT REPORTING

PNSP Contractor shall provide coordination and all supporting project documentation for weekly NG9-1-1 Prime Service meetings/updates with CA 9-1-1 Branch, including the Text to 9-1-1 deployment plan.

20.3 PNSP SYSTEM MONITORING DASHBOARD

PNSP Contractor shall provide a system that will monitor, display and report the health of the Prime and Regional networks from ingress to egress of all 9-1-1 traffic. Monitoring system shall meet all technical requirements in accordance with EXHIBIT 21, EXHIBIT 21, PRIME TECHNICAL REQUIREMENTS.

20.4 PNSP NG9-1-1 SERVICE REPORTING

PNSP Contractor shall provide the required SLA reports per the SOW, SLA Section 32.

20.5 PNSP TEXT TO 9-1-1 SERVICE REPORTING

PNSP Contractor shall provide the required SLA reports per the SOW, SLA Section 32.

20.6 PNSP TEXT TO 9-1-1 SESSION REPORTING

PNSP Contractor shall provide full reports of the Text to 9-1-1 sessions to the PSAPs in a secure and always available on-line platform.

20.7 RNSP NG9-1-1 SERVICE OUTAGE REPORTING

RNSP Contractor shall provide the required outage reporting per the CA 9-1-1 Branch procedures and technical requirements EXHIBIT 23 REGION TECHNICAL REQUIREMENTS.

20.8 RNSP NG9-1-1 SERVICE PROJECT REPORTING

RNSP Contractor shall provide coordination and all supporting project documentation for weekly NG9-1-1 Region Service meetings/updates with CA 9-1-1 Branch.

20.9 RNSP SYSTEM MONITORING DASHBOARD

RNSP Contractor shall provide a system that will monitor, display and report the health of the Regional networks from ingress to egress of all 9-1-1 traffic and provide reporting system monitoring data to the PNSP. Monitoring system shall meet all technical requirements in accordance with EXHIBIT 23, REGION TECHNICAL REQUIREMENTS.

20.10 RNSP NG9-1-1 SERVICE REPORTING

Contractor shall provide the required SLA reports per the SOW, SLA Section 32.

21 SECURITY (PNSP AND RNSP)

Contractor shall provide all security and monitoring for the Prime NG9-1-1 Services per the requirement EXHIBIT 21, PRIME TECHNICAL REQUIREMENTS and EXHIBIT 23, REGION TECHNICAL REQUIREMENTS.

22 DISASTER RECOVERY (PNSP AND RNSP)

PNSP and RNSP Contractor is fully responsible for developing and implementing a disaster recovery plan to identify how the NGCS system tactically recovers from a disaster or situation that compromises the performance of NG9-1-1 services. This plan shall focus on alert, notification, response, restoration activities and the management of any event identified as a disaster that may cause harm to the system. The Disaster Recovery Plan shall be delivered within 30 days of Contract award for review and approval. The PNSP shall provide a step by step emergency re-route procedures from each Regional NG9-1-1 Network to the PSAP 90 calendar days, or mutually agreed upon date, prior to Region Network go-live. The RNSP shall provide a step by step emergency re-route procedures from awarded Regional NG9-1-1 Network to the PNSP for delivery to PSAP 90 days, or mutually agreed upon date, prior to Region Network go-live. The requirements are as follows:

- 1) The Disaster Recovery strategy must be consistent regardless of event or trigger;
- 2) An assessment process must be applied to the Disaster Recovery process;
- 3) Ownership of all facets of the plan must be defined;
- 4) Management teams and reporting scenarios must be defined;
- 5) Response teams must be identified;
- 6) Key decision makers and escalation lists must be defined;
- 7) Procedures of communication must be defined.

The goal of the Disaster Recovery plan is to create and document a playbook that includes procedures for a single source of management of the event for rapid escalation, triage, problem management, and communications.

The Disaster Recovery Plan must include:

- 1) Activation procedures;
- 1) Recovery team identification;
- 2) Roles and responsibilities ;
- 3) Recovery strategies and response;
- 4) Recovery management procedures;
- 5) Recovery cost procedures;
- 6) Recovery resources;
- 7) Recovery communications;
- 8) Stakeholder management.

Disaster recovery shall contain, but not limited to, the items listed in EXHIBIT 21, EXHIBIT 21, Prime Technical Requirements and EXHIBIT 23, REGION TECHNICAL REQUIREMENTS. Contractor shall provide the Disaster Recovery Plan within 30 calendar days after award or a mutually agreed upon date for CA 9-1-1 Branch to review and approve.

23 CONTINUITY OF OPERATIONS PLAN (PNSP AND RNSP)

The Contractor must develop and maintain a Continuity of Operations Plan for the NGCS. Whereas the Disaster Recovery plan is concerned with response, mitigation and recovery; the Continuity of Operations plan must focus on ensuring that all critical services, and functions may still be carried out in the wake of a disruption, as well as after a disruption has been recognized. The Continuity of Operations Plan must include measures to account for common threats and vulnerabilities that may make a significant disruption more likely. The Contractor shall treat the Continuity of Operations Plan as a long term strategic plan to ensure continued operation in spite of disasters, disruptions or service limiting events.

The Continuity of Operations plan may include the following areas:

- 1) Backup facilities and redundancy such as mobile sites, hot sites, warm sites, and cold sites;
- 2) Backup software, storage and procedures for all data and files;
- 3) Redundant and diverse communications paths and systems;
- 4) Backup power, power supplies and power generation;
- 5) Complete redundant systems utilizing alternate technology;
- 6) Personnel and resources to support continued operations;
- 7) Subscription services;
- 8) Cyber incident redundancy and recovery support;
- 9) Call trees;
- 10) Crisis communications;

11) Succession plans.

Contractor shall provide the Continuity of Operations Plan within one month after contract execution or a mutually agreed upon date for CA 9-1-1 Branch to review and approve. The PNSP shall provide a step by step emergency re-route procedures from each Regional NG9-1-1 Network to the PSAP 90 calendar days, or mutually agreed upon date, prior to Region Network go-live. The RNSP shall provide a step by step emergency re-route procedures from awarded Regional NG9-1-1 Network to the PNSP for delivery to PSAP 90 days, or mutually agreed upon date, prior to Region Network go-live.

24 AGGREGATION SERVICE (PNSP AND RNSP)

The PNSP contractor shall provide an OSP traffic aggregation service for all OSPs in the State of California excluding wireless, AT&T wireline, Consolidated Communications wireline and Frontier wireline as defined in EXHIBIT 21, PRIME TECHNICAL REQUIREMENTS. PNSP shall provide aggregation connections to all Wireless OSPs that are in “hot standby” mode to enhance aggregation capabilities. The PNSP shall provide aggregation service that supports Text to 9-1-1 requirements in EXHIBIT 21, PRIME TECHNICAL REQUIREMENTS.

The RNSP contractor shall provide an OSP traffic aggregation service for all wireless, AT&T wireline, Consolidated Communications wireline and Frontier wireline OSPs in the awarded Region in the State of California as defined in EXHIBIT 23, REGION TECHNICAL REQUIREMENTS.

25 AGGREGATION “HOT STANDBY” PLAN (PNSP)

The PNSP Contractor shall provide an aggregation plan to support wireless, AT&T wireline, Consolidated Communications wireline and Frontier wireline as directed by CA 9-1-1 Branch. Aggregation services for wireless, AT&T wireline, Consolidated Communications wireline and Frontier wireline will be the responsibility of the RNSP provider however, in certain emergency situation CA 9-1-1 Branch may need to contact the Contractor to perform services as required. This plan will support the need to aggregate OSP traffic in the event that a regional aggregation service needs to be replaced with another aggregation service provider. In this emergency situation, the PNSP would take on the OSP aggregation responsibility and would be required to execute their Aggregation Plan. The PNSP does not have primary responsibility to aggregate OSP traffic. The PNSP would rely on the RNSP to deliver 9-1-1 traffic to the PNSP. This aggregation plan would only be utilized in emergency situations; however, must be in active standby mode and plan must include a test cycle. The replacement of the OSP aggregation service provider would be directed by CA 9-1-1 Branch. The aggregation plan is needed to support emergency situations.

26 COMPATIBILITY AND INTERFACE (PNSP AND RNSP)

The PNSP Contractor is responsible for all PNSP Network connections, as defined by Interconnection Agreements, and all related NG911 service interfaces from the ingress of any 9-1-1 traffic type at the aggregation service providers Point of Interface (POI) to the egress of any 9-1-1 traffic type to any of the possible PSAP Call Processing Equipment site or host configurations by managed gateway and as directed by CA 9-1-1 Branch. The Contractor shall provide the interfaces to interconnect to each RNSP as directed by CA 9-1-1 Branch and per the applicable requirements in EXHIBIT 21, PRIME TECHNICAL REQUIREMENTS. Demarcation points shall be defined by Interconnection Agreements between interconnecting service providers. Contractor shall provide 9-1-1 traffic flow architecture to support the design overview.

The RNSP Contractor is responsible for all RNSP Network connections in the awarded Region, as defined by Interconnection Agreements, and all related NG911 service interfaces from the ingress of any 9-1-1 traffic type at the aggregation service providers POI to the egress of any 9-1-1 traffic type to any of the possible PSAP Call Processing Equipment site or host configurations by managed gateway and as directed by CA 9-1-1 Branch. The RNSP Contractor shall provide the interfaces to interconnect to the PNSP as directed by CA 9-1-1 Branch and per the applicable requirements in EXHIBIT 23, REGION TECHNICAL REQUIREMENTS. Demarcation points shall be defined by Interconnection Agreements between interconnecting service providers. RNSP Contractor shall provide 9-1-1 traffic flow architecture to support the design overview.

The EXHIBIT 22 COST WORKBOOK defines the prices for interfaces, NG9-1-1 Trunks and POIs. The CA 9-1-1 Branch will work with the PNSP and RNSP to approve items in the Cost Workbook to support the Project Plan. In the event PNSP or RNSP determines the need for an item in the COST WORKBOOK the CA 9-1-1 Branch will validate the need and ensure alignment with SOW prior to approval.

26.1 STATEWIDE CAPSNET INTERFACE (PNSP)

PNSP Contractor shall provide a plan to interface with the statewide California Public Safety Microwave Network (CAPSNET) backhaul as redundant path to each PSAP as defined in EXHIBIT 21, PRIME TECHNICAL REQUIREMENTS. The CA 9-1-1 Branch will provide additional information on the CAPSNET plan upon contract execution.

27 SYSTEM/SERVICE INSTALLATION (PNSP AND RNSP)

Contractor shall provide a detailed installation, implementation, and training plan to the CA 9-1-1 Branch for review and approval within 30 calendar days of Contract Execution.

The Contractor's plan shall include the time provisions specified in EXHIBIT 21, PRIME TECHNICAL REQUIREMENTS and EXHIBIT 23, REGION TECHNICAL REQUIREMENTS.

28 TECHNOLOGY REFRESH (PNSP AND RNSP)

PNSP Contractor shall provide the CA 9-1-1 Branch, in writing, within 12 months from contract execution, a plan to maintain and update all hardware and software services on the Prime NG9-1-1 Service. The PNSP Contractor agrees Prime NG9-1-1 Services shall not be disrupted while performing hardware and/or software upgrades, in accordance to EXHIBIT 21 PRIME TECHNICAL REQUIREMENTS. PNSP Contractor shall provide all technology refreshes, to include training, equipment and technician hours at no cost to the State.

RNSP Contractor shall provide the CA 9-1-1 Branch, in writing, within 12 months from contract execution, a plan to maintain and update all hardware and software services on the Region NG9-1-1 Service. The RNSP Contractor agrees Region NG9-1-1 Services shall not be disrupted while performing hardware and/or software upgrades, in accordance to EXHIBIT 23 REGION TECHNICAL REQUIREMENTS. RNSP Contractor shall provide all technology refreshes, to include training, equipment and technician hours at no cost to the State.

29 KNOWLEDGE TRANSFER AND TRAINING (PNSP AND RNSP)

Contractor shall provide Train-the-Trainer course for CA 9-1-1 Branch personnel and not to exceed one (1) eight (8)-hour training course for the Network Reporting System. Contractor shall conduct training within 45 calendar days of the scheduled "Go Live" date and shall provide all training resources at the time of training. Contractor shall be responsible to maintain current versions of the training materials and provide training material to the CA 9-1-1 Branch for the duration of service.

29.1 PSAP NG TEXT TO 9-1-1 TRAINING (PNSP)

Contractor shall provide all PSAP training as Train-the-Trainer and training materials to PSAP(s) who deployed web-based Over-the-Top (OTT) NG Text-to-9-1-1 Solutions. Contractor shall coordinate training dates with each of PSAP and training shall be completed prior to the 'Go-Live' date. Contractor is not require to provide integrated Text-to-9-1-1 training.

30 MAINTENANCE (PNSP AND RNSP)

PNSP Contractor shall be responsible for all maintenance to the Prime NG9-1-1 Services for the term of the Contract. RNSP Contractor shall be responsible for all maintenance to the Region NG9-1-1 Services for the term of the Contract. A final maintenance plan shall

be submitted to CA 9-1-1 Branch for review and approval within 90 calendar days from Contract execution. Planned or unplanned maintenance shall not disrupt 9-1-1 service and/or trigger any SLAs.

Maintenance Schedule shall include at a minimum:

- 1) Hardware Issues;
- 2) Servers;
- 3) Switches;
- 4) Routers;
- 5) Software Issues;
- 6) Operating System Software Issues;
- 7) Security System Software Issues;
- 8) Connectivity Issues.

31 PSAP HELP DESK/CALL CENTER (PNSP AND RNSP)

Contractor shall provide a point of contact 24 hours a day, 7 days a week, 365 days a year, for CA 9-1-1 Branch, PSAP, PNSP and RNSP personnel to report trouble on the respective NG9-1-1 Services in accordance with requirements as identified in EXHIBIT 21, PRIME TECHNICAL REQUIREMENTS and EXHIBIT 23, REGION TECHNICAL REQUIREMENTS. The Contractor shall provide help desk and call center service in accordance with EXHIBIT 21, TECHNICAL REQUIREMENTS and EXHIBIT 23, REGION TECHNICAL REQUIREMENTS.

32 SERVICE LEVEL AGREEMENTS (SLA) (PNSP AND RNSP)

32.1 A SINGLE OUTAGE COULD TRIGGER MULTIPLE SLAS.SLA CONTRACTOR'S MONTHLY ACTIVITY REPORT (PNSP AND RNSP)

By the 10th of each month, the Contractor shall provide the CA 9-1-1 Branch with a detailed report of the service level made under this Contract using Monthly Technical SLA Compliance Report listed below, Contractor's Monthly Activity Report, SLA Section 32. The CA 9-1-1 Branch reserves the right to require the Contractor to modify the format and content of these reports during the Contract term at no cost. At the conclusion of each month's meeting, CA 9-1-1 Branch will advise Contractor on any SLAs that have not been met. Contractor agrees this will be final notification and will move forward with any appropriate credit/or adjustment for the next billing cycle. Contractor agrees this meeting shall serve as notification in compliance with the SLA terms. The remedy for each missed SLA shall be solely determined by the State.

32.1.1 THE CONTRACTOR'S MONTHLY ACTIVITY REPORT

Monthly Activity Report shall include at a minimum the fields listed below:

- 1) ID;
- 2) PSAP Name Impacted;
- 3) Month Date;
- 4) Day/Time Start;
- 5) Day/Time End;
- 6) Duration Hour: Min
- 7) Reporting Entity;
- 8) Outage Type;
- 9) Cause of Incident/Outage;
- 10) Summary of Incident/Outage;
- 11) Yes/no if qualified for SLA;
- 12) The applicable SLA;
- 13) Rights and remedies applied to each ticket when applicable;
- 14) Other.

32.1.2 PNSP NG9-1-1 TARIFF SERVICES TO BE IDENTIFIED IN THE MONTHLY ACTIVITY REPORT ARE:

- 1) NGCS;
- 2) NG9-1-1 Alert and Warning;
- 3) Aggregation;
- 4) NG9-1-1 Trunk
- 5) NG Text to 9-1-1;

6) Statewide GIS.

**32.1.3 RNSP NG9-1-1 TARIFF SERVICES TO BE IDENTIFIED IN THE MONTHLY
ACTIVITY REPORT ARE:**

- 1) NGCS;
- 2) Aggregation;
- 3) NG9-1-1 Trunk.

32.2 SLA REPORTING REQUIREMENTS – ADMINISTRATIVE

32.2.1 PNSP Project Deployment Plan (PDP)			
Definition	Measurement Method	Objective	Rights and Remedies
Final PNSP PDP shall be delivered within 60 calendar days of contract execution to CA 9-1-1 Branch.	Calendar Days	Delivery of PNSP PDP within 60 days.	Failure to meet the objective shall result in a \$5,000.00 credit/or adjustment for each calendar day that the report is not delivered after the objective.

32.2.2 RNSP Project Deployment Plan (PDP)			
Definition	Measurement Method	Objective	Rights and Remedies
Final RNSP PDP shall be delivered within 60 calendar days of contract execution to CA 9-1-1 Branch.	Calendar Days	Delivery of RNSP PDP within 60 days.	Failure to meet the objective shall result in a \$5,000.00 credit/or adjustment for each calendar day that the report is not delivered after the objective.

32.2.3 PNSP and RNSP Interface and Integration Collaboration for Project Deployment Plan (PDP)

Definition	Measurement Method	Objective	Rights and Remedies
<p>PNSP and RNSP shall begin collaboration 60 days from contract execution of each region.</p>	<p>Calendar Days</p>	<p>To initiate and ensure collaboration for Interface and Integration of the NG9-1-1 Services.</p>	<p>Failure to meet the objective shall result in a \$5,000.00 credit/or adjustment for each calendar day that the report is not delivered after the objective.</p>
<p>Final Interface and Integration PDP shall be delivered within 120 calendar days after contract execution of each awarded region.</p>	<p>Calendar Days</p>	<p>To ensure collaboration for Interface and Integration of the NG9-1-1 Services.</p>	<p>Failure to meet the objective shall result in a \$5,000.00 credit/or adjustment for each calendar day that the report is not delivered after the objective.</p>

32.2.4 Unauthorized Modification Project Deployment Plan (PDP)			
Definition	Measurement Method	Objective	Rights and Remedies
Contractor shall not modify any CA 9-1-1 Branch approved milestones in the PDP.	Calendar Days	Completion of PDP milestones within the date agreed by the State and Contractor.	Any unauthorized modification to the PDP shall result in a \$50,000.00 credit/or adjustment plus \$5,000.00 for each calendar day that the PDP is not restored to the approved version.

32.2.5 PNSP and RNSP Interface and Integration Implementation of Project Deployment Plan (PDP)			
Definition	Measurement Method	Objective	Rights and Remedies
PNSP and RNSP shall complete and comply with the Interface and Integration Plan based on the approved SOW Attachment 8 – Project Milestone Report.	Calendar Days	To eliminate finger pointing and complete the Interface and Integration of the NG9-1-1 Services.	Failure to meet the objective shall result in a \$5,000.00 credit/or adjustment for each calendar day that the report is not delivered after the objective. Additionally a Senior Staff Member from both the RNSP and PNSP that fail to meet this SLA shall appear before the CA 9-1-1 Advisory Board as

			directed be the CA 9-1-1 Branch.
--	--	--	-------------------------------------

32.2.6 Failure to Meet Project Deployment Plan (PDP) Milestone Dates			
Definition	Measurement Method	Objective	Rights and Remedies
Contractor shall achieve all milestone dates identified in the PDP.	Calendar Days	Completion of PDP milestones within the date agreed by the CA 9-1-1 Branch and Contractor.	Any failure to meet the objective shall result in a \$5,000.00 credit/or adjustment for each calendar day that the milestone is not delivered after the objective.

32.2.7 Budget SLA Remittance			
Definition	Measurement Method	Objective	Rights and Remedies
SLA Remedy Delivery Timely credit/or adjustment of remedies due to the CA 9-1-1 Branch for missed SLA objectives.	Calendar Days.	Contractor’s credit/or adjustment shall be issued no more than 60 calendar days after written notice from the CA 9-1-1 Branch.	Each occurrence of an SLA remedy (credit/or adjustment) that is not issued within 60 calendar days shall result in a \$5,000.00 credit/or adjustment for each calendar day that the credit/or adjustment is not issued.

32.3 SLA REPORTING REQUIREMENTS – TECHNICAL

The following technical SLAs provide charts describing the definition, measurement method, objective, and rights and remedies for each category. The following SLAs are not intended to supersede any regulatory or statutory requirements and/or penalties imposed by the FCC, CPUC, or any other legislative oversight.

32.3.1 System Monitoring			
Definition	Measurement Method	Objective	Rights and Remedies
Contractor shall deliver all System Monitoring Access 24/7/365.	The monthly availability percentage equals the Scheduled Uptime per month less Unavailable Time divided by Scheduled Uptime per month multiplied by 100. Scheduled uptime is based on 24x number of days in the month. The monthly Availability percentage shall be based on the cumulative total of all outage durations for each calendar month.	99.999%	<p>Failure to meet the SLA objective for one month shall result in a 25% credit/or adjustment of the Total Monthly Recurring Cost (TMRC) of all System Monitoring services under contract for that month.</p> <p>Next consecutive month fail to meet the SLA objective shall result in a 50% credit/or adjustment of the TMRC of all System Monitoring services under contract for that month.</p> <p>Each additional consecutive month fail to meet the SLA objective shall result in a 100% credit/or adjustment of the TMRC of all System Monitoring services under contract for that month.</p>

32.3.2 System Outage Notification			
Definition	Measurement Method	Objective	Rights and Remedies
Contractor shall report all outages that potentially impact the delivery of 9-1-1 traffic within ten (10) minutes of the occurrence.	Any outage that potentially impacts the delivery of 9-1-1 traffic.	Notification within ten (10) minutes or less.	Any failure to meet the objective shall result in a \$5,000.00 credit/or adjustment Next consecutive minute that the Contractor fails to meet the SLA objective shall result in an additional \$1,000.00 credit/or adjustment per minute, up to the TMRC for all System Monitoring services.

32.4 SLA NG9-1-1 TRUNK SERVICE – AVAILABILITY CHART

NG9-1-1 Trunk Service Availability			
Definition	Measurement Method	Objective	Rights and Remedies
<p>The overall NG9-1-1 Trunk Service shall be available to each end point connection.</p>	<p>The monthly availability percentage equals the Scheduled Uptime per month less Unavailable Time divided by Scheduled Uptime per month multiplied by 100. Scheduled uptime is based on 24x number of days in the month. The NG9-1-1 Trunk Service availability requires two diverse NG9-1-1 Trunk Connections to each PSAP. For those PSAPs where diverse NG9-1-1 Trunks are not available and when approved by CA 9-1-1 Branch, the Individual NG9-1-1 Trunks Service applies. The monthly Availability percentage shall be based on the cumulative total of all outage durations for each calendar month.</p>	<p>99.999%</p>	<p>Failure to meet the SLA objective for one month shall result in a 25% credit/or adjustment of the TMRC for NG9-1-1 Trunk Service for that month.</p> <p>Failure to meet the SLA objective for the next consecutive month shall result in a 50% credit/or adjustment of the TMRC for NG9-1-1 Trunk Service for that month.</p> <p>Failure to meet the SLA objective for each additional consecutive month shall result in a 100% credit/or adjustment of the TMRC for that month plus an additional \$50,000.</p>

Individual NG9-1-1 Trunk Service Availability			
Definition	Measurement Method	Objective	Rights and Remedies
Individual NG9-1-1 Trunk Service shall be available to each end point connection and will only apply when diverse NG9-1-1 trunks are not available and when approved by CA 9-1-1 Branch.	<p>The monthly availability percentage equals the Scheduled Uptime per month less Unavailable Time divided by Scheduled Uptime per month multiplied by 100.</p> <p>Scheduled uptime is based on 24x number of days in the month.</p> <p>The monthly Availability percentage shall be based on the cumulative total of all outage durations for each calendar month.</p>	99.9%	<p>Failure to meet the SLA objective for one month shall result in a 25% credit/or adjustment of the TMRC for the impacted individual NG9-1-1 Trunk Services.</p> <p>Next consecutive month fail to meet the SLA objective shall result in a 100% credit/or adjustment of the TMRC for the impacted individual Trunk Services.</p> <p>Each additional consecutive month fail to meet the SLA objective shall result in a 200% credit/or adjustment of the impacted individual NG9-1-1 Trunk Services.</p>

32.5 SLA AGGREGATION SERVICE – AVAILABILITY CHART

Aggregation Service Availability			
Definition	Measurement Method	Objective	Rights and Remedies
<p>The NG9-1-1 Aggregation Service shall be available to combine all identified incoming OSPs including Text to 9-1-1 OSPs for the PNSP.</p>	<p>The monthly availability percentage equals the Scheduled Uptime per month less Unavailable Time divided by Scheduled Uptime per month multiplied by 100. Scheduled uptime is based on 24x number of days in the month. The monthly Availability percentage shall be based on the cumulative total of all outage durations for each calendar month.</p>	<p>99.999%</p>	<p>Failure to meet the SLA objective for one month shall result in a 25% credit/or adjustment of the TMRC for Aggregation Service for that month.</p> <p>Next consecutive month fail to meet the SLA objective shall result in a 50% credit/or adjustment of the TMRC for that month.</p> <p>Each additional consecutive month fail to meet the SLA objective shall result in a 100% credit/or adjustment of the TMRC for that month plus an additional \$50,000.</p>

32.6 SLA NG CORE SERVICES AVAILABILITY

A Core Service Outage is defined as the failure to deliver a call properly presented (i.e. Address, or Latitude/Longitude or Cell Sector) to the Core Services to some PSAPs due to a failure in some part of the Contractors solution. The Core Services availability shall have an uptime of at least 99.999%.

Note that delivering a call to an alternate or default CA PSAP due to an Emergency Services IP Network (ESInet) connectivity problem, a CA PSAP problem or other external circumstance not part of the Contractors solution, is not defined as a Core Service Outage.

Core Service Availability			
Definition	Measurement Method	Objective	Rights and Remedies
The NG9-1-1 core service will deliver 9-1-1 traffic including location information to the appropriate CPE.	The monthly availability percentage equals the Scheduled Uptime per month less Unavailable Time divided by Scheduled Uptime per month multiplied by 100. Scheduled uptime is based on 24x number of days in the month. The monthly Availability percentage shall be based on the accumulative total of all outage durations for each calendar month.	99.999%	Failure to meet the SLA objective for one month shall result in a 25% credit/or adjustment of the TMRC of NG9-1-1 Core Service. Next consecutive month to fail to meet the SLA objective shall result in a 50% credit/or adjustment of the TMRC of NGCS. Each additional consecutive month to fail to meet the SLA objective shall result in a 100% credit/or adjustment of the TMRC of NGCS plus

			an additional \$50,000.
--	--	--	----------------------------

32.7 SLA NG CORE SERVICES – ROUTING FAILURE

A Routing Failure is defined as the failure to select the correct preferred PSAPs for a call based on the information accompanying the call, including any and all parts of the NG9-1-1 Core Services. Incorrect routing due to incorrect or missing data accompanying the call, or due to incorrect GIS database entries provided by the authoritative service, or alternate routing due to factors such as CA PSAP conditions, or network outages not under the Contract resulting control of the Contractor, are not considered Routing Failures. The SLA requires that 99.999% of all calls be free of Routing Failures.

Routing Failure			
Definition	Measurement Method	Objective	Rights and Remedies
The failure to select the correct preferred PSAP for a call based on the information accompanying the call and the contents of the GIS and Policy Databases within NGCS.	The monthly number of calls that are routed to a specific PSAP divided by the number of calls the information accompanying the call and the contents of the GIS and Policy Databases indicate should have been routed to that specific PSAP multiplied by 100.	99.999%	<p>Failure to meet the SLA objective for one month shall result in a 25% credit/or adjustment of the TMRC of NGCS.</p> <p>Next consecutive month to fail to meet the SLA objective shall result in a 50% credit/or adjustment of the TMRC of NGCS.</p> <p>Each additional consecutive month to fail to meet the SLA objective shall result in a 100% credit/or adjustment of the TMRC of NGCS plus an additional \$50,000.</p>

32.8 SLA NG CORE SERVICE – VOICE QUALITY MEAN OPINION SCORE (MOS)

NG Core Network Services must forward voice calls with little or no degradation of voice quality of the call from the ingress demarcation point to the egress demarcation point, as measured and monitored by an automated MOS measurement tool between various ingress and egress points at times when the ESInet is meeting its performance parameters. MOS values shall be measured hourly unless a problem has been detected, in which case measurements shall be made at five (5) minute intervals as necessary, 99% of the MOS measurements shall exceed two-point-six (2.6), and 90% of the MOS measurements shall exceed three-point-eight (3.8). If the ESInet is not meeting performance standards and while a Trouble Ticket is open on the ESInet performance problem, then substandard MOS measurements shall not be charged against the Contractors performance.

NG CORE NETWORK SERVICE – MOS			
Definition	Measurement Method	Objective	Rights and Remedies
NG Core Network Services must forward voice calls with little or no degradation of voice quality of the call from the ingress demarcation point to the egress demarcation point, as measured and monitored by an automated Mean Opinion Score (MOS) measurement tool between various ingress and egress points at times when the ESInet is meeting its performance parameters.	MOS values shall be measured hourly unless a problem has been detected	At five (5) minute intervals, 99% of the MOS measurements shall exceed 2.6 and 90% shall exceed 3.8.	25% credit/or adjustment of TMRC of NG9-1-1 Core Services for single occurrence. 50% credit/or adjustment of TMRC of NG9-1-1 Core Services for second occurrence with a 60 minute period. 100% credit/or adjustment of TMRC of NG9-1-1 Core Services for third occurrence with a 60 minute period.

32.9 SLA NG CORE SERVICE – CATASTROPHIC OUTAGE 1

Core Service Catastrophic Outage 1

Definition	Measurement Method	Objective	Rights and Remedies
The NG9-1-1 core service will deliver 9-1-1 traffic including location information to the appropriate NG9-1-1 CPE.	Single outage with a duration of six (6) minutes or more.	Preventing outages of six (6) minutes or more.	100% credit/or adjustment of the TMRC of NGCS plus an additional \$50,000.

32.10 SLA NG CORE SERVICE – CATASTROPHIC OUTAGE 2

Catastrophic Outage 2			
Definition	Measurement Method	Objective	Rights and Remedies
The NG9-1-1 Core Service will deliver 9-1-1 traffic including location information to the appropriate NG9-1-1 CPE.	Single outages of greater than two (2) minutes and less than six (6) minutes.	Preventing outages greater than two (2) minutes, but less than six (6) minutes.	50% credit/or adjustment of the TMRC of NGCS.

32.11 SLA PRIME NG TEXT TO 9-1-1 SERVICE AVAILABILITY CHART

NG Text to 9-1-1 Service Availability			
Definition	Measurement Method	Objective	Rights and Remedies
NG Text to 9-1-1 Service shall deliver text calls to the appropriate PSAP for every PSAP in the State, within the Contractor's control.	The monthly availability percentage equals the Scheduled Uptime per month less Unavailable Time divided by Scheduled Uptime per month multiplied by 100. Scheduled uptime is based on 24x number of days in the month. The monthly Availability percentage shall be based on the	99.999%	Failure to meet the SLA objective for one month shall result in a 25% credit/or adjustment of the TMRC of NG Text to 9-1-1 for that month. Next consecutive month fail to meet the SLA objective shall result in a 50% credit/or adjustment of the TMRC of NG

	accumulative total of all outage durations for each calendar month.		Text to 9-1-1 for that month. Each additional consecutive month fail to meet the SLA objective shall result in a 100% credit/or adjustment of the TMRC of NG Text to 9-1-1 for that month plus additional \$10,000.
--	---	--	--

32.12 SLA PRIME NG TIME TO RESTORE – TEXT SERVICE FAILURE CHART

Time to Repair – Text Service Failure			
Definition	Measurement Method	Objective	Rights and Remedies
NG Text to 9-1-1 service shall deliver text calls to the appropriate PSAP for every PSAP in the State, within the Contractor's control.	Single outage with a duration of two (2) minutes to five (5) minutes.	Outages greater than two (2) minutes	25% credit/or adjustment of the TMRC for NG Text to 9-1-1.
NG Text to 9-1-1 service shall deliver text calls to the appropriate PSAP for every PSAP in the State, within the Contractor's control.	Single outage with a duration of six (6) minutes to 29 minutes.	Outages greater than six (6) minutes.	50% credit/or adjustment of the TMRC for NG Text to 9-1-1.

<p>NG Text to 9-1-1 service shall deliver text calls to the appropriate PSAP for every PSAP in the State, within the Contractor's control.</p>	<p>Single outage with a duration of 30 minutes to 59 minutes.</p>	<p>Outages greater than 30 minutes.</p>	<p>100% credit/or adjustment of the TMRC.</p>
<p>NG Text to 9-1-1 service shall deliver text calls to the appropriate PSAP for every PSAP in the State, within the Contractor's control.</p>	<p>Single outage with a duration of 60 minutes or more.</p>	<p>Outages greater than 60 minutes.</p>	<p>100% credit/or adjustment of the TMRC plus an additional \$5,000 for NG Text to 9-1-1.</p>

32.13 SLA PRIME NG TIME TO TRANSITION TEXT-TO-9-1-1 SERVICE

<p>Time to transition Text-to-9-1-1 Service</p>			
<p>Definition</p>	<p>Measurement Method</p>	<p>Objective</p>	<p>Rights and Remedies</p>
<p>All PSAPs who have already deployed text with web or integrated service, as of Contract award, must be transitioned to the awarded Contractor no less than one (1) year of the Contract execution date.</p>	<p>The number of PSAPs deployed with text service as of the contract award date that have signed and submitted the SOW NG Prime Text-to-9-1-1 Acceptance and Authorization Check List.</p>	<p>To transition a minimum of 100 PSAPs that are currently text deployed within the first six months of contract award date.</p> <p>The remaining Text</p>	<p>Any of the first 100 PSAPs transitioning within the first six (6) months that have not signed system acceptance shall result in a 100% credit/or adjustment for a total of each Monthly Recurring Costs (MRC).</p> <p>For the remaining PSAPs transitioning within the first 12 months that</p>

		<p>deployed PSAPs shall be transitioned to the NG9-1-1 Services - Prime contract within 12 months of the contract award date.</p>	<p>have not signed system acceptance shall result in a 100% credit/or adjustment for a total of each MRC plus an additional \$5,000.</p> <p>Any PSAP deployed that has not transitioned by 24 months after contract award date shall result in a 100% credit/or adjustment for a total of each MRC. Plus an additional \$10,000.</p>
--	--	---	--

32.14 SLA PRIME NG TIME TO DEPLOY NEW TEXT-TO-9-1-1 SERVICE

Time to deploy Text-to-9-1-1 Service			
Definition	Measurement Method	Objective	Rights and Remedies
The contractor shall have 180 days to deploy text for any PSAP's initial request to deploy text for web or integrated.	From the Text Deployment Status report, the time measured in calendar days from the date of the requested order approved.	Any text deployment shall be provisioned, tested and live, with final acceptance signed by the PSAP within 180 days of request to take text.	Every month, or any portion of a month after 180 days, shall result in a 100% credit/or adjustment for a total of each MRC.

32.15 NG9-1-1 ALERT AND WARNING SYSTEM (NG9-1-1 AWS)

NG9-1-1 Alert and Warning System (NG9-1-1 AWS)			
Definition	Measurement Method	Objective	Rights and Remedies
The PNSP shall provide NG9-1-1 AWS to broadcast notifications to a pre-selected geographic area and/or delivery of an IPAWS message.	Single outages of greater than five (5) minutes.	99.99%.	25% credit/or adjustment of the TMRC for NG9-1-1 AWS.
The PNSP shall provide AWS to broadcast notifications to a pre-selected geographic area and/or delivery of an IPAWS message.	Single outage with a duration of greater than five (5) minutes to 29 minutes.	99.99%	50% credit/or adjustment of the TMRC for NG9-1-1 AWS.

The PNSP shall provide AWS to broadcast notifications to a pre-selected geographic area and/or delivery of an IPAWS message.	Single outage with a duration of 30 minutes to 59 minutes.	99.99%	100% credit/or adjustment of the TMRC for NG9-1-1 AWS.
The PNSP shall provide AWS to broadcast notifications to a pre-selected geographic area and/or delivery of an IPAWS message.	Single outage with a duration of 60 minutes or more.	99.99%	100% credit/or adjustment of the TMRC plus an additional \$5,000 for NG9-1-1 AWS.

32.16 TECHNICAL SLA COMPLIANCE REPORT

The PNSP and each RNSP shall submit Monthly SLA Compliance Report for each NG service type shall be provided in the format listed below. The PNSP and RNSPs shall submit a monthly report to the CA 9-1-1 Branch no the 10th of each month following the end of the reporting month that reflects the status of all SLA objectives that were not met during the previous month, including the rights and remedies. The report shall list all Trouble Tickets that were open and/or acted upon during the reported month, including tickets not qualifying for SLA remedy. This report shall show what SLA rights and remedies were applied to each ticket number, when applicable. If no Trouble Tickets were opened and/or acted upon during a month, the report shall state there were no issues or tickets for that month. The CA 9-1-1 Branch may review this with the Contractor every month, to determine if the monthly technical SLA compliance report needs to be adjusted to support the overall CA 9-1-1 Branch fiscal oversight.

The monthly SLA compliance report shall include the following detail:

- 1) Report period;
- 2) Contractor’s trouble ticket number;
- 3) PSAP name;

- 4) PSAP FCC ID;
- 5) Service type;
- 6) Brief trouble symptom;
- 7) Brief restoration description;
- 8) Ticket open date and time;
- 9) Problem resolution date and time;
- 10) Total stop clock duration, outage duration;
- 11) Yes/no if qualified for SLA;
- 12) The applicable SLA; and
- 13) Rights and remedies applied to each ticket when applicable.

32.17 NG TECHNICAL SLA COMPLIANCE REPORT CHART

NG Technical Compliance Report SLA			
Definition	Measurement Method	Objective	Rights and Remedies
<p>Reporting Requirement</p> <p>The Contractor shall provide the SLA reports required by this contract for each month of activity during the term of the contract by the 10th business day of the following month</p>	<p>Business Days.</p>	<p>The Contractor shall deliver accurate and complete reports by the 10th of the month following the end of the applicable reporting month.</p>	<p>Failure to meet the objective shall result in a \$5,000.00 credit/or adjustment for each business day that the report is not delivered after the objective.</p>

32.18 UNPLANNED DOWNTIME REPORTING

UNPLANNED DOWNTIME REPORTING SLA			
Definition	Measurement Method	Objective	Rights and Remedies
The Contractor shall provide an initial root cause analysis within 48 hours.	Business Days	The Contractor shall deliver initial root cause analysis to CA 9-1-1 Branch and the affected PSAPs within 48 hours of unplanned failure.	Each occurrence of a failure to meet the objective shall result in a \$5,000.00 credit/or adjustment for each business day that the report is not delivered after the objective.
Disclosure for Unplanned Downtime and Root Cause Analysis shall be provided within 15 business days.	Business Days.	The Contractor shall deliver disclosure reports to CA 9-1-1 Branch and the affected PSAPs within 15 business days of unplanned failure.	Each occurrence of a failure to meet the objective shall result in a \$5,000.00 credit/or adjustment for each business day that the report is not delivered after the objective.

32.19 STOP CLOCK CONDITIONS (PNSP and RNSP)

The following Stop-Clock Conditions shall apply for any of the SLA Categories, during the term of this Contract including any and all extensions. Timeframes are dependent on the length of time the Contractor takes to restore the NG9-1-1 service, minus the time associated with events outside of the Contractor’s control to prevent punitive damages

from being assessed. At any time the Contractor can contact the CA 9-1-1 Branch to discuss Stop Clock conditions that may not be identified below.

32.20 STOP CLOCK – REQUEST FOR DELAY (PNSP and RNSP)

Periods when restoration or testing effort is delayed at the specific request of the PSAP or CA 9-1-1 Branch. The Stop-Clock condition shall exist during the period the Contractor was delayed, provided that reasonable and documented efforts are made to contact the PSAPs during the applicable Stop-Clock period.

32.21 STOP CLOCK – REQUEST FOR OBSERVATION (PNSP and RNSP)

Time after a service has been restored, but the PSAP or CA 9-1-1 Branch requests ticket be kept open for observation. If the service is later determined by the PSAP or CA 9-1-1 Branch to not have been restored, the Stop-Clock shall continue until the time the PSAP or CA 9-1-1 Branch notifies the Contractor that the service has not been restored.

32.22 STOP CLOCK – RESTORATION NOT VERIFIED (PNSP and RNSP)

Time after a service has been restored, but the PSAP or CA 9-1-1 Branch is not available to verify that the service is working. If the service is later determined by the PSAP or CA 9-1-1 Branch, to not have been restored, the Stop-Clock shall apply only for the time period between Contractor's reasonable attempt to notify the PSAP or CA 9-1-1 Branch that Contractor believes the service has been restored and the time the PSAP or CA 9-1-1 Branch notifies the Contractor that the service has not been restored.

32.23 STOP CLOCK – LACK OF ENTRANCE (PNSP and RNSP)

Lack of building entrance facilities or conduit structure that are the PSAPs responsibility to provide.

32.24 STOP CLOCK – SITE READINESS REQUIREMENTS (PNSP and RNSP)

PSAPs failure to prepare the site in accordance with the Contractor's Site Readiness Requirements.

32.25 STOP CLOCK – PSAP CONTACT/ACCESS PROBLEM (PNSP and RNSP)

The following contact/access problems, provided that Contractor makes reasonable efforts to contact the PSAPs during the applicable stop-clock period:

- 1) Access necessary to correct the problem is not available because access has not been arranged by site contact or the PSAPs representative;
- 2) Site contact refuses access to technician who displays proper identification;

- 3) Insufficient or incorrect site contact information which prevents access, provided that Contractor takes reasonable steps to notify the PSAPs of the improper contact information and takes reasonable steps to obtain the correct information;
- 4) Site has limited hours of business that directly impacts the Contractor's ability to resolve the problem;
- 5) If it is determined later that the cause of the problem was not at the site in question, then the Stop-Clock shall not apply;
- 6) Any problem or delay to the extent caused by PSAPs staff that prevents or delays Contractor's resolution of the problem. In such event, Contractor shall make a reasonable request to PSAPs staff to correct the problem or delay;
- 7) PSAPs applications that interfere with repair of the trouble;
- 8) Failure of the Trouble Ticket originator or responsible party to return a call from Contractor's technician for on-line close-out of Trouble Tickets after the service has been restored as long as Contractor can provide documentation substantiating message from Contractor's technician.

32.26 STOP CLOCK – UNAPPROVED ALTERATIONS (PNSP and RNSP)

If service failure is caused by alterations or attachments not furnished, approved or maintained by the Contractor.

32.27 REPORTING TROUBLE TICKET LOG (PNSP and RNSP)

The Contractor shall maintain a Trouble Ticket Log that will track the progress and status of restoration for all SLAs. The Contractor's Trouble Ticket Log will include the date and time that each Failure was reported, or system/service alarm of failure whichever occurs first, each PSAP affected by the failure, the current status of the restoration process and the date and time that the failure is remedied to the CA 9-1-1 Branch representative's satisfaction. The Contractor shall provide web-portal, 24 hour, seven (7) day, access to the CA 9-1-1 Branch in order to track progress of the restoration of failures and to validate SLA calculations.

32.28 UNPLANNED DOWNTIME DISCLOSURE AND ROOT CAUSE ANALYSIS (PNSP and RNSP)

In the event an individual NG Core Service component is impacted by unplanned downtime, (such as a failure), the Contractor shall provide, at the request of the CA 9-1-1 Branch and/or PSAPs, a written disclosure statement within two (2) calendar weeks via email which shall include but not be limited to:

- 1) The component that failed;

- 2) The duration the component was impacted;
- 3) Impact to the overall service due to the component failure – including impacted PSAPs by FCC Identification (ID);
- 4) Corrective action taken to recover the component.

In addition to the above disclosure the Contractor shall provide a root cause analysis to the CA 9-1-1 Branch and affected PSAPs within 15 business days. The Contractor shall provide an initial root cause analysis within 48 hours and then update the CA 9-1-1 Branch and PSAPs every five (5) business days until root cause is determined.

Root cause analysis shall identify the root cause of failure and corrective action to prevent a like failure in the future.

33 UNANTICIPATED/ NEW TECHNOLOGY TASKS (PNSP and RNSP)

This Contract shall include Unanticipated/New Technology Tasks, the cost of which shall be calculated on an hourly basis per EXHIBIT 22, COST WORKBOOK. These tasks shall include only services, including work products, not specifically set forth in this Contract, but which are subsequently identified as in-scope and necessary for the successful delivery of the services described in this Contract. Prior to commencement of any work being performed for Unanticipated/ New Technology Tasks, the Contractor shall have received an approved Work Order Authorizations (WOA) for such work. The labor rates for Unanticipated/ New Technology Tasks shall not exceed the hourly rates as stated in EXHIBIT 22, COST WORKBOOK. WOAs for Unanticipated/New Technology Tasks shall include the Contractor's estimated number of hours required to complete the work, multiplied by the hourly labor rates specified in EXHIBIT 22, COST WORKBOOK. The CA 9-1-1 Branch will release payment for any WOA upon the CA 9-1-1 Branch acceptance criteria specified in the approved WOA in accordance with SOW section 36, BUDGET DETAIL AND PAYMENT PROVISIONS.

33.1 Work ORDER AUTHORIZATIONS (PNSP and RNSP)

- 1) The WOA establishes that the CA 9-1-1 Branch and Contractor have a common understanding of the scope, schedule, format, content (depth and breadth), estimated hours per task by staff member and acceptance criteria of work products required prior to the Contractor beginning work. The CA 9-1-1 Branch and Contractor will define and develop Acceptance Criteria and these tasks shall be assigned to the Contractor, including specific, measurable success factors, to be set forth in the WOA. The tasks and any potential work products must be listed in the WOA form. The WOA details Contractor services required to meet project objectives.

- 2) All Contractor work shall be authorized in advance via the WOA process, see SOW - Attachment 6 for the WOA form. Once the WOA has been reviewed and accepted the Contractor and CA 9-1-1 Branch NG9-1-1 Manager, or designee, will sign it. This will constitute acceptance of the WOA. The originally approved WOA will be retained by the CA 9-1-1 Branch NG9-1-1 Manager with copies sent to the Contractor.
- 3) It is understood and agreed by both parties that all of the terms and conditions of this contract shall remain in force with the inclusion of any such WOA.
- 4) If, in the performance of the work, the Contractor determines that the work approved through the WOA cannot be accomplished within the estimated work hours, the Contractor will immediately notify the CA 9-1-1 Branch NG9-1-1 Manager in writing of the Contractor's estimate additional hours to complete the work in full. Upon receipt of such notification, CA 9-1-1 Branch may:
 - a) Alter the scope of the WOA in order to define tasks that can be accomplished within the remaining estimated work hours by issuance of an approved WOA amendment or
 - b) Terminate the WOA.

34 CONTRACTOR SERVICE ORDERING PROCESS – 9-1-1 TARIFFED SERVICES (PNSP and RNSP)

In California the NG9-1-1 Service Provider is required to follow the steps outlined below when ordering items or services that are governed by CPUC tariffs. Once approved and submitted, invoices will be billed by the contractor to the CA 9-1-1 Branch for direct payment.

- 1) Prime Network Service Provider submits supporting documentation to CA 9-1-1 Branch

The contractor will submit the following to the CA 9-1-1 Branch:

- a) Copy of completed TDe-289 form (SOW Attachment 2 – TDe-289);
- b) Tariff pricing for each line item and reference to NG9-1-1 Tariff filing;
- c) Change in project pricing, including NRC and MRC, broken out by item or service.

A CA 9-1-1 Branch NG9-1-1 Manager will review the documents for compliance to the established tariffs and assign an internal tracking number to the overall project.

- 2) CA 9-1-1 Branch issues TDe-289 to contractor:

Once the documents have been reviewed and approved by the CA 9-1-1 Branch, the assigned NG9-1-1 Manager will generate a TDe-289 form. The form will be routed internally for CA 9-1-1 Designee signature. Once signed, the NG9-1-1 Manager will return an approved copy to the contractor. This will serve as official "approval" of the project and the contractor can proceed with ordering.

3) Contractor orders services/proceeds with project:

The Contractor may then order services and proceed with the project. All related invoices shall be submitted to the CA 9-1-1 Branch for direct payment, pursuant to the terms and conditions of the executed SOW.

35 INSURANCE REQUIREMENTS (PNSP and RNSP)

Insurance Requirements – Contractor shall comply with all requirements outlined in the one (1) General Provisions section and two (2) Contract Insurance Requirements outlined in this section. No payments will be made under this contract until contractor fully complies with all requirements.

1) **General Provisions Applying to All Policies**

- a) **Coverage Term** – Coverage needs to be in force for the complete term of the contract. If insurance expires during the term of the contract, a new certificate must be received by the State at least 30 days prior to the expiration of this insurance. Any new insurance must comply with the original contract terms of the contract;
- b) **Policy Cancellation or Termination & Notice of Non-Renewal** – Contractor is responsible to notify the State within five (5) business days of any cancellation, non-renewal or material change that affects required insurance coverage. New certificates of insurance are subject to the approval of the Department of General Services and the Contractor agrees no work or services will be performed prior to obtaining such approval. In the event Contractor fails to keep in effect at all times the specified insurance coverage, the State may, in addition to any other remedies it may have, terminate this Contract upon the occurrence of such event, subject to the provisions of this Contract;
- c) **Premiums, Assessments and Deductibles** – Contractor is responsible for any premiums, policy assessments, deductibles or self-insured retentions contained within their insurance program;
- d) **Primary Clause** – Any required insurance contained in this contract shall be primary, and not excess or contributory, to any other insurance carried by the State;
- e) **Insurance Carrier Required Rating** – All insurance companies must carry an AM Best rating of at least "A-" with a financial category rating of no lower

than VII. If the Contractor is self-insured for a portion or all of its insurance, review of financial information including a letter of credit may be required;

- f) **Endorsements** – Any required endorsements requested by the State must be physically attached to all requested certificates of insurance and not substituted by referring to such coverage on the certificate of insurance;
- g) **Inadequate Insurance** – Inadequate or lack of insurance does not negate the contractor's obligations under the contract;
- h) **Available Coverages/Limits** – All coverage and limits available to the contractor shall also be available and applicable to the State;
- i) **Satisfying an Self Insured Retention (SIR)** - All insurance required by this contract must allow the State to pay and/or act as the contractor's agent in satisfying any SIR. The choice to pay and/or act as the contractor's agent in satisfying any SIR is at the State's discretion;
- j) **Use of Subcontractors** - In the case of Contractor's utilization of subcontractors to complete the contracted scope of work, contractor shall include all subcontractors as insured's under Contractor's insurance or supply evidence of subcontractor's insurance to The State equal to policies, coverages, and limits required of Contractor.

2) **Contract Insurance Requirements**

Contractor shall display evidence of the following on a certificate of insurance evidencing the following coverages:

a) **Commercial General Liability**

Contractor shall obtain, at Contractor's expense, and keep in effect during the term of this Contract, Commercial General Liability Insurance covering bodily injury, and property damage in a form and with coverages that are satisfactory to the State. This insurance shall include personal and advertising injury liability, products, completed operations, and contractual liability coverage for the indemnity provided under this Contract. Coverage shall be written on an occurrence basis in an amount not be less than \$1,000,000 per occurrence. Annual aggregate limit shall not be less than \$2,000,000. **The State of California, its officers, agents, and employees are to be covered as additional insureds with respect to liability arising out of work or operations.**

b) **Automobile Liability**

Contractor shall maintain motor vehicle liability with limits of not less than \$1,000,000 combined single limit. Such insurance shall cover liability arising out of a motor vehicle including owned, hired, and non-owned motor vehicles. **The State of California, its officers, agents, and employees are to**

be covered as additional insureds with respect to liability arising out of work or operations.

c) **Workers' Compensation and Employer's Liability**

Workers' Compensation insurance as required by the State of California, with Statutory Limits, and Employer's Liability Insurance with limit of no less than \$1,000,000 per accident for bodily injury or disease. **Policy shall be endorsed to include a waiver of subrogation in favor of State of California.**

d) **Technology Professional Liability/Errors and Omissions Insurance**

appropriate to the Contractors profession and work hereunder, with limits not less than \$5,000,000 per occurrence. Coverage shall be sufficiently broad to respond to the duties and obligations as is undertaken by the Contractor in this agreement and shall include, but not be limited to, claims involving infringement of intellectual property, copyright, trademark, invasion of privacy violations, information theft, release of private information, extortion and network security. The policy shall provide coverage for breach response costs as well as regulatory fines and penalties as well as credit monitoring expenses with limits sufficient to respond to these obligations.

1. The Policy shall include, or be endorsed to include, **property damage liability coverage** for damage to, alteration of, loss of, or destruction of electronic data and/or information "property" of the State in the care, custody, or control of the Contractor. If not covered under the Contractors liability policy, such "property" coverage of the may be endorsed onto the Contractors Cyber Liability Policy as covered property as follows:

Cyber Liability Coverage in an amount sufficient to cover the full replacement value of damage to, alteration of, loss of, or destruction of electronic data and/or information "property" of the State that will be in the care, custody, or control of Vendor.

2. **If Policy is written on a claims-made basis provide the following:**

- a) The Retroactive Date must be shown, and must be before the date of the Contract or the beginning of contract work;
- b) Insurance must be maintained and evidence of insurance must be provided **for at least five (5) years after completion of the contract of work;**

- c) If coverage is canceled or non-renewed, and not replaced **with another claims-made policy form with a Retroactive Date prior to** the Contract effective date, the Contractor must purchase “extended reporting” coverage for a minimum of **five (5)** years after completion of work.
- 3) **Other Required Insurance Provisions.** Certificate of Insurance must also contain all of the following provisions:
- a) Name and address of the insurance company, the policy number, and the beginning and ending dates of the policy;
 - b) Statement requiring the Insurer to provide written notice to Cal OES 30 calendar days prior to canceling Contractor's policy;
 - c) Statement that CA 9-1-1 Branch, its officers, agents, servants and employees are included as additional insured on the policy, but only insofar as the services under this Contract are concerned;
 - d) Statement that neither CA 9-1-1 Branch, nor any of its agencies, will be responsible for any premium or assessment on said policies;
 - e) The Contractor shall submit the certificate of insurance, identifying the California Governor’s Office of Emergency Services contract number, to
CA 9-1-1 Branch at the following address:

California Governor’s Office of Emergency Services
Procurement and Logistical Services
Attention:
3650 Schriever Avenue
Mather, CA 95655

To expedite processing, certificates may be faxed to: (916) 845-8303

36 BUDGET DETAIL AND PAYMENT PROVISIONS (PNSP and RNSP)

- 1) The Contractor shall be limited to two (2) months of back billing including any reconciliation effort, on all services and functionality ordered under the Contract. Invoices presented more than 12 months after the formal acceptance of the service or functionality will not be considered valid and shall not be paid;
- 2) The Contractor shall reconcile incorrect invoices within 30 calendar days from the date of notification by CA 9-1-1 Branch of the discrepancy. CA 9-1-1 Branch shall suspend all current charges when unresolved disputed items extend beyond 90 days. Remittance shall resume to include any outstanding payments, upon resolution;
- 3) The Contractor shall issue invoices to CA 9-1-1 Branch for only those milestone services after system testing and acceptance, as agreed by CA 9-1-1 Branch. The NRC and the MRC shall be on separate invoices;
- 4) The Contractor shall render invoices for total monthly service charges following the month for which the charges accrue. Monthly service billing shall only be billed in full month increments after service has been rendered;
- 5) The Contractor shall provide invoices under this Contract in accordance with the CA 9-1-1 Branch Operations Manual. Example: Exhibit A, SOW, SOW - Attachment 1 NG9-1-1 SERVICE INVOICE TEMPLATE.
- 6) All invoices submitted to the CA 9-1-1 Branch as a result of this Contract will be billed separately from other charges the Contractor may currently be billing. Invoices not received in the approved format shall not be processed;
- 7) Payment for services performed under this contract shall not exceed the rates listed in EXHIBIT 22 COST WORKBOOK. It shall be the CA 9-1-1 Branch NG9-1-1 Manager's sole determination as to whether a service has been successfully completed and is acceptable;
- 8) Submit electronic invoices with reference to the Contract number to:

Email: CA911Invoicing@caloes.ca.gov
California Governor's Office of Emergency Services
Public Safety Communications
Attention: CA 9-1-1 Branch

9-1-1 Reconciliation Unit
601 Sequoia Pacific Blvd., MS9-1-1
Sacramento CA 95811

- 9) The Contractor shall not assess late fees for any reason.
- 10) The Contractor costs related to items such as travel or per diem are costs of the Contractor and will not be paid separately as part of this Contract.

36.1 BUDGET CONTINGENCY CLAUSE (PNSP and RNSP)

- 1) Payment will be made in accordance with, and within the time specified in, Government Code Chapter 4.5, commencing with Section 927. Payment to small/micro businesses shall be made in accordance with and within the time specified in Chapter 4.5, Government Code 927 et seq.
- 2) It is mutually agreed that if the Budget Act of the current year and/or any subsequent years covered under this Contract does not appropriate sufficient funds for the program, this Contract shall be of no further force and effect. In this event, CA 9-1-1 Branch shall have no liability to pay any funds whatsoever to the Contractor or to furnish any other considerations under this Contract and Contractor shall not be obligated to perform any provisions of this Contract.
- 3) If funding for any fiscal year is reduced or deleted by the Budget Act for purposes of this program, CA 9-1-1 Branch shall have the option to either cancel this Contract with no liability occurring to the CA 9-1-1 Branch, or offer an amendment to the Contract to reflect the reduced amount.

SOW - ATTACHMENT 1: NG9-1-1 SERVICE INVOICE SAMPLE TEMPLATE



1
 Your Company Name
 Street Address
 City, ST ZIP Code
 Phone

2
DATE
 Date

3
CONTRACT/TRACKING NO
 Number

4
APPROVED AMOUNT
 \$\$\$

5
INVOICE NO
 Number

6
INVOICE TO: Cal OES, CA 9-1-1 BRANCH
 Attn: Name/Project Name
 601 Sequoia Pacific Blvd, MS-911
 Sacramento, CA, 95811-0231

7
SHIP TO: Co # Psap Name Svc Type
 Attn: Name/ Psap Name
 Street Address
 City, ST ZIP Code

9 ← **10** → **11** **12**

TERMS	COUNTY CODE	PSAP LOCATION, DEPT TYPE	SERVICE NO	SERVICE PERIOD	DUE DATE

13 ITEM #	14 DESCRIPTION	15 QUANTITY	16 UNIT PRICE	17 LINE TOTAL
	Product description	#Amount	\$Amount	\$Amount

18
Total USD

SOW - ATTACHMENT 1a: NG9-1-1 SERVICE INVOICE TEMPLATE INSTRUCTIONS

- 1) NOTE: * each section in the invoice template and the TDe-289 are numbered in red. CONTRACTOR: Name, Address and Direct contact number for inquires on this account (Ref. TDe-289 Contractor Name Part 1);
- 2) INVOICE NO: Invoice issue date;
- 3) CONTRACT/TRACKING NO: Contract number Ref. TDe-289 Part 3a) and state tracking number 'mandatory' (Ref. TDe-289 Part 3b);
- 4) APPROVED AMOUNT: cost approved on TDe-289 for one time or Recurring as applicable;
- 5) INVOICE NO: Contractor invoice number identifier;
- 6) INVOICE TO: (Ref. TDe-289 Part 6a)

Email: CA911Invoicing@caloes.ca.gov

Cal OES, CA 9-1-1 Branch

601 Sequoia Pacific Blvd, MS-911

Sacramento, Ca 95811-0231

- 7) ATTN: 'name of NG9-1-1 Manager 'optional' (Ref. TDe-289 Part 6b) SHIP TO (1st LINE): County Code, PSAP name, Service Number (Ref. TDe-289 Part 10 or fill in the appropriate county code and service type following table 1 and 2, PSAP name refer to TDe-289 Part 8);
- 8) SHIP TO: PSAP name and the location address of your delivery service (Ref. TDe-289 Part 8);
- 9) TERMS: the invoice cycle for this service [ex: 1 means the first bill, etc.];
- 10) COUNTY CODE, PSAP LOCATION, DEPT TYPE, SERVICE TYPE: Replicate Section 7 (Ref. TDe-289 Part 10);
- 11) SERVICE PERIOD: date and month through date and month (ex: 07/01/2018 – 07/31/2018);
- 12) DUE DATE: the due date of the invoice;
- 13) NG SERVICE #: Next Generation Service number (Ref. TDe-289 Part 13);
- 14) DESCRIPTION: description of NG9-1-1 Service and reference to NG9-1-1 Tariff Filing (Ref. TDe-289 Part 14) [ex: PSAP location, size];
- 15) QUANTITY: unit of measure and number of services;
- 16) UNIT PRICE: U.S. dollar amount per quantity;
- 17) LINE TOTAL: per NG Service total amount;
- 18) TOTAL: total amount due.

NG9-1-1 Service Invoice Template Instructions

Table 1 County Code

CO #	COUNTY	CO #	COUNTY
01	Alameda	31	Placer
02	Alpine	32	Plumas
03	Amador	33	Riverside
04	Butte	34	Sacramento
05	Calaveras	35	San Benito
06	Colusa	36	San Bernardino
07	Contra Costa	37	San Diego
08	Del Norte	38	San Francisco
09	El Dorado	39	San Joaquin
10	Fresno	40	San Luis Obispo
11	Glenn	41	San Mateo
12	Humboldt	42	Santa Barbara
13	Imperial	43	Santa Clara
14	Inyo	44	Santa Cruz
15	Kern	45	Shasta
16	Kings	46	Sierra
17	Lake	47	Siskiyou
18	Lassen	48	Solano
19	Los Angeles	49	Sonoma
20	Madera	50	Stanislaus
21	Marin	51	Sutter
22	Mariposa	52	Tehama
23	Mendocino	53	Trinity
24	Merced	54	Tulare
25	Modoc	55	Tuolumne
26	Mono	56	Ventura
27	Monterey	57	Yolo
28	Napa	58	Yuba
29	Nevada	97	Cal Fire (statewide)
30	Orange	98	CHP (statewide)

Table 2 Service Type

SV #	Service Type	SV #	Service Type
27	Text to 9-1-1 Services	31	9-1-1 Statewide GIS
28	9-1-1 Trunk & Trans Services	32	9-1-1 Aggregation Services
29	NG 9-1-1 Core Services	32	Miscellaneous

SOW - ATTACHMENT 3 - PSAP LIST

California Statewide Statistics and PSAP Location Information

The California PSAPs listed below represent those funded by the CA 9-1-1 Branch. Not all PSAPs request/receive funding from the CA 9-1-1 Branch; therefore, the list is not inclusive of all PSAPs in California. Some NG9-1-1 Core Services with an ESINet exist today or are *planned* and are designated by "CE" or "CP". Some PSAPs contain Evergreen Network based Turnkey Call Handling Systems that are *existing* or *planned*, designated by "EE" or "EP". The remaining PSAPs are all Stand-Alone CPE, designated as "Blank" in the status field, or Host-Remote Call Handling Systems, designated with an "HS" as defined below.

The list designates if the PSAP currently received Text to 9-1-1 calls or is planning to but not yet deployed, but may be by the time the contract is awarded. All PSAPs without a predefined deliver modality will be determined at the time of deployment, if prior to contract award, or deploy with integrated text as defined in this contract.

#	FCC ID	PSAP NAME	LOCATION	STATUS	TEXT	# OF POS RANGE
1	8225	Alameda County Regional Fire/LLNL	Livermore		W / PD	11-29
2	523	Alameda County Sheriff's Department	San Leandro		W / D	6-10
3	524	Alameda Police Department	Alameda			6-10
4	525	Albany Police Department	Albany			1-5
5	526	Alhambra Police/Fire Department	Alhambra	EE, CP	W / D	1-5
6	528	Amador County Sheriff's Department	Jackson			1-5
7	530	Anaheim Police Department	Anaheim			11-29
8	532	Antioch Police Department	Antioch		W / D	6-10
9	533	Arcadia Police Department	Arcadia		W / D	1-5
10	534	Arcata Police Department	Arcata		I / PD	1-5
11	536	Arvin Police Department	Arvin		W / PD	1-5
12	537	Atascadero Police Department	Atascadero		W / D	1-5
13	538	Atherton Police Department	Atherton		W / D	1-5
14	539	Atwater Police Department	Atwater		W / PD	1-5
15	540	Auburn Police Department	Auburn	HS-P		1-5
16	542	Avalon Fire Department	Avalon		W / D	1-5
17	544	Azusa Police Department	Azusa		W / D	1-5

#	FCC ID	PSAP NAME	LOCATION	STATUS	TEXT	# OF POS RANGE
18	545	Bakersfield Police Department	Bakersfield		W / PD	11-29
19	546	Baldwin Park Police Department	Baldwin Park		W / D	1-5
20	547	Banning Police Department	Banning		W / D	1-5
21	548	Barstow Police Department	Barstow		W / D	1-5
22	8114	Bay Area Rapid Transit (BART) Police Dept.	Oakland			1-5
23	551	Beaumont Police Department	Beaumont		W / D	1-5
24	552	Bell Gardens Police Department	Bell Gardens		W / PD	1-5
25	553	Bell Police Department	Bell			1-5
26	554	Belmont Police Department	Belmont		W / D	1-5
27	555	Benicia Police Department	Benicia			1-5
28	556	Berkeley Police/Fire Communications Center	Berkeley			6-10
29	558	Beverly Hills Police Department	Beverly Hills	EE, CP	W / D	1-5
30	560	Bishop Police Department	Bishop			1-5
31	561	Blythe Police Department	Blythe			1-5
32	562	Brawley Police Department	Brawley	HS-I	W / D	1-5
33	563	Brea Police Department	Brea			6-10
34	8531	Brentwood Police Department	Brentwood		W/ PD	1-5
35	567	Buena Park Police Department	Buena Park			6-10
36	568	Burbank Police Department	Burbank	EE, CP	W / D	1-5
37	569	Burlingame Police Department	Burlingame		W / D	1-5
38	571	Butte County Sheriff's Department	Oroville	CP, HS-B	I / D	6-10
39	574	Calaveras County Sheriff's Department	San Andreas			1-5
40	576	Calexico Police Department	Calexico	HS-I	W / PD	1-5
41	589	CAL-FIRE Camino (Amador/El Dorado Unit)	Camino			6-10
42	599	CAL-FIRE El Cajon (San Diego Unit)	El Cajon			6-10
43	601	CAL-FIRE Felton (San Mateo/Santa Cruz)	Felton			1-5
44	725	CAL-FIRE Fortuna (Humboldt/Del Norte Unit)	Fortuna			1-5

#	FCC ID	PSAP NAME	LOCATION	STATUS	TEXT	# OF POS RANGE
45	591	CAL-FIRE Fresno (Fresno/Kings Unit)	Fresno			1-5
46	596	CAL-FIRE Grass Valley (Nevada/Yuba/Placer)	Grass Valley			6-10
47	592	CAL-FIRE Mariposa (Madera/Mariposa/Merced)	Mariposa			1-5
48	594	CAL-FIRE Monterey (San Benito/Monterey)	Monterey			1-5
49	602	CAL-FIRE Morgan Hill (Santa Clara Unit)	Morgan Hill			1-5
50	570	CAL-FIRE Oroville (Butte Unit)	Oroville	CP, HS-B	I / D	1-5
51	597	CAL-FIRE Perris (Riverside Unit)	Perris			11-29
52	605	CAL-FIRE Red Bluff (Tehama/Glenn Unit)	Red Bluff	CP		1-5
53	603	CAL-FIRE Redding (Shasta/Trinity Unit)	Redding	CP		1-5
54	606	CAL-FIRE San Andreas (Tuolumne/Calaveras)	San Andreas			1-5
55	598	CAL-FIRE San Bernardino (San Bernardino)	San Bernardino			1-5
56	600	CAL-FIRE San Luis Obispo (San Luis Obispo)	San Luis Obispo			1-5
57	595	CAL-FIRE St Helena (Sonoma/Lake/Napa)	St Helena			1-5
58	992	CAL-FIRE Susanville (Lassen/Modoc Unit)	Susanville	CP		1-5
59	1004	CAL-FIRE Visalia (Tulare Unit)	Visalia			1-5
60	593	CAL-FIRE Willits (Mendocino Unit)	Willits			1-5
61	607	CAL-FIRE Yreka (Siskiyou Unit)	Yreka	CP		1-5
62	577	California City Police Department	California City		W / PD	1-5
63	579	Calistoga Police Department	Calistoga			1-5
64	581	Campbell Police Department	Campbell			1-5
65	582	Carlsbad Police Department	Carlsbad			1-5
66	584	Carmel Police Department	Carmel		W / D	1-5
67	587	Cathedral City Police Department	Cathedral City		W / D	6-10
68	609	Ceres Police Department	Ceres			6-10

#	FCC ID	PSAP NAME	LOCATION	STATUS	TEXT	# OF POS RANGE
69	8116	Cerritos College Police Department	Norwalk		W / D	1-5
70	610	Chico Police Department	Chico	CP, HS-B	I / D	6-10
71	612	Chino Police Department	Chino		W / D	6-10
72	613	Chowchilla Police Department	Chowchilla			1-5
73	637	CHP Atwater (Merced)	Atwater		W / PD	30+
74	614	CHP Bakersfield (Kern)	Bakersfield		W / PD	11-29
75	615	CHP Barstow (San Bernardino)	Barstow		W / D	1-5
76	616	CHP Bishop (Inyo)	Bishop		W / PD	11-29
77	617	CHP Border Comm Center	San Diego		W / PD	30+
78	618	CHP Capitol Communications Center	Sacramento		W / PD	1-5
79	619	CHP Chico (Butte)	Chico	CP	W / D	1-5
80	620	CHP El Centro (Imperial)	Imperial		W / D	1-5
81	623	CHP Eureka (Humboldt)	Arcata		W / PD	1-5
82	621	CHP Fresno	Fresno		W / PD	1-5
83	624	CHP Indio (Riverside)	Indio		W / PD	11-29
84	625	CHP Inland (San Bernardino)	Fontana		W / D	30+
85	639	CHP Irvine (Orange)	Irvine		W / PD	11-29
86	626	CHP Los Angeles	Los Angeles		W / D	30+
87	641	CHP Rancho Cordova (Sacramento)	Rancho Cordova		W / D	30+
88	640	CHP Redding (Shasta)	Redding	CP	W / PD	1-5
89	638	CHP Salinas (Monterey)	Salinas		W / D	11-29
90	642	CHP San Luis Obispo	San Luis Obispo		W / D	1-5
91	643	CHP Stockton (San Joaquin)	Stockton		W / PD	11-29
92	644	CHP Susanville (Lassen)	Susanville	CP	W / PD	1-5
934	647	CHP Ukiah (Mendocino)	Ukiah		W / PD	6-10
95	622	CHP Vallejo/Golden Gate (Solano)	Vallejo		W / D	11-29
96	648	CHP Ventura	Ventura		W / PD	11-29
97	649	CHP Yreka (Siskiyou)	Yreka	CP	W / PD	1-5
98	650	Chula Vista Police Department	Chula Vista			6-10
99	8255	Citrus Heights Police Department	Citrus Heights		W / PD	6-10
100	653	Claremont Police Department	Claremont		W / D	1-5

#	FCC ID	PSAP NAME	LOCATION	STATUS	TEXT	# OF POS RANGE
101	654	Cloverdale Police Department	Cloverdale			1-5
102	655	Clovis Police Department	Clovis			1-5
103	658	Coalinga Police Department	Coalinga			1-5
104	659	Coloma Police Department	Coloma		W / PD	1-5
105	660	Colton Police Department	Colton		W / D	6-10
106	661	Colusa County Sheriff's Department	Colusa	CP		1-5
107	663	Concord Police Department	Concord		W / PD	6-10
108	911	CONFIRE - San Bernardino County Fire (Rialto)	Rialto		W / D	11-29
109	665	Contra Costa County Fire Protection District	Pleasant Hill		W / PD	6-10
110	666	Contra Costa County Sheriff's Department	Martinez		W / PD	6-10
111	667	Corcoran Police Department	Corcoran			1-5
112	669	Corning Fire Department	Corning	CP		1-5
113	668	Corning Police Department	Corning	CP		1-5
114	670	Corona Police Department	Corona			6-10
115	671	Coronado Police Department	Coronado			1-5
116	672	Costa Mesa Police Department	Costa Mesa			6-10
117	673	Cotati Police Department	Cotati			1-5
118	674	Covina Police Department	Covina		W / D	1-5
119	8074	CSU Channel Island Police Department	Camarillo			1-5
120	677	CSU Chico Police Department	Chico	CP, HS-B	I / D	1-5
121	678	CSU Dominguez Hills Police Department	Carson		W / D	1-5
122	8115	CSU East Bay Police Department	Hayward		W / PD	1-5
123	679	CSU Fresno Police Department	Fresno			1-5
124	680	CSU Fullerton Police Department	Fullerton			1-5
125	758	CSU Humboldt Police Department	Arcata			1-5
126	8118	CSU Long Beach University Police	Long Beach		W / D	1-5
127	681	CSU Los Angeles Police Department	Los Angeles		W / D	1-5

#	FCC ID	PSAP NAME	LOCATION	STATUS	TEXT	# OF POS RANGE
128	682	CSU Northridge University Police	Northridge		W / D	1-5
129	573	CSU Pomona (Cal Poly) Police Department	Pomona		W / D	1-5
130	683	CSU San Bernardino Police Department	San Bernardino		W / D	1-5
131	684	CSU San Diego Police Department	San Diego			1-5
132	929	CSU San Francisco Police Department	San Francisco			1-5
133	685	CSU San Jose Police Department	San Jose			1-5
134	8124	CSU San Luis Obispo (Cal Poly) Police Dept.	San Luis Obispo		W / PD	1-5
135	8256	CSU San Marcos Police Department	San Marcos			1-5
137	691	Davis Police Department	Davis		W / PD	1-5
138	692	Del Norte County Sheriff's Department	Crescent City			1-5
139	693	Delano Police Department	Delano		W / PD	1-5
140	694	Dinuba Police Department	Dinuba			1-5
141	8231	Dos Palos Police Department (Westside Regional Comm)	Dos Palos		W / PD	1-5
142	695	Downey Fire Department	Downey		W / D	1-5
143	696	Downey Police Department	Downey		W / D	6-10
144	697	East Bay Regional Park District	Castro Valley			1-5
145	702	El Cajon Police Department	El Cajon			1-5
146	703	El Camino Community College District Police	Torrance		W / D	1-5
147	705	El Centro Police Department	El Centro	HS-I	W / D	1-5
148	708	El Dorado County Sheriff's Department	Placerville		W / PD	1-5
149	709	El Monte Police Department	El Monte		W / D	6-10
150	8155	Elk Grove Police Department	Elk Grove		W / D	6-10
151	711	Emeryville Police Department	Emeryville			1-5
152	713	Escondido Police Department	Escondido			6-10
153	715	Eureka Police Department	Eureka			6-10
154	717	Fairfax Police Department	Fairfax			1-5
155	718	Fairfield Police Department	Fairfield			1-5
156	722	Firebaugh Police Department	Firebaugh			1-5

#	FCC ID	PSAP NAME	LOCATION	STATUS	TEXT	# OF POS RANGE
157	723	Folsom Police Department	Folsom		I / PD	1-5
158	724	Fontana Police Department	Fontana		W / D	6-10
159	726	Fortuna Police Department	Fortuna			1-5
160	727	Foster City Police Department	Foster City		W / D	1-5
161	728	Fountain Valley Police Department	Fountain Valley			1-5
162	730	Fremont Police Department	Fremont			6-10
163	731	Fresno County EMS	Fresno			6-10
164	732	Fresno County Sheriff's Department	Fresno			6-10
165	733	Fresno Police Department	Fresno			11-29
166	737	Fullerton Police Department	Fullerton			6-10
167	738	Galt Police Department	Galt		W / PD	1-5
168	739	Garden Grove Police Department	Garden Grove			6-10
169	740	Gilroy Police Communications	Gilroy			1-5
170	741	Glendale Police Department	Glendale	EE,CP	W / D	6-10
171	742	Glendora Police Department	Glendora		W / D	1-5
172	743	Glenn County Sheriff's Department	Willows	CP		1-5
173	745	Gridley Police Department	Gridley	CP, HS-B	I / D	1-5
174	746	Grover Beach Police Department	Grover Beach		W / PD	1-5
175	748	Hanford Police Department	Hanford			1-5
176	749	Hayward Police Department	Hayward		W / D	6-10
177	750	Healdsburg Police Department	Healdsburg			1-5
178	751	Heartland Communications Facility Authority-Fire	El Cajon			6-10
179	752	Hemet Police Department	Hemet			1-5
180	754	Hillsborough Police Department	Hillsborough		W / PD	1-5
181	757	Humboldt County Sheriff's Department	Eureka			1-5
182	759	Huntington Beach Police Department	Huntington Beach			6-10
183	760	Huntington Park Police Department	Huntington Park		W / D	1-5
184	761	Huron Police Department	Huron			1-5

#	FCC ID	PSAP NAME	LOCATION	STATUS	TEXT	# OF POS RANGE
185	764	Imperial County Sheriff's Department	El Centro	HS-I	W / D	1-5
186	765	Indio Police Department	Indio		W / D	1-5
187	766	Inglewood Police/Fire Department Comm.	Inglewood		W / D	6-10
188	767	Inyo County Sheriff's Department	Independence			1-5
189	768	Irvine Police Department	Irvine			6-10
190	769	Irwindale Police Department	Irwindale		W / D	1-5
191	8242	Kern County Fire Department	Bakersfield		W / PD	11-29
192	771	Kern County Sheriff's Department	Bakersfield		W / PD	11-29
193	772	Kings County Sheriff's Department	Hanford			6-10
194	774	La Habra Police Department	La Habra			1-5
195	775	La Mesa Police Department	La Mesa			1-5
196	776	La Palma Police Department	La Palma			1-5
197	777	La Verne Police/Fire Department	La Verne		W / D	1-5
198	778	Laguna Beach Police Department	Laguna Beach			1-5
199	779	Lake County Sheriff's Department	Lakeport		I / PD	1-5
200	586	LASD - Carson Sheriff's Station	Carson	HS-LAS	W / D	1-5
201	608	LASD - Century Sheriff's Station	Lynwood	HS-LAS	W / D	6-10
202	8117	LASD - Cerritos Sheriff's Station	Cerritos	HS-LAS	W / D	1-5
203	662	LASD - Compton Sheriff's Station	Compton	HS-LAS	W / D	6-10
204	676	LASD - Crescenta Valley Sheriff's Station	La Crescenta	HS-LAS	W / D	1-5
205	698	LASD - East Los Angeles Sheriff's Station	Los Angeles	HS-LAS	W / D	1-5
206	652	LASD - Industry Sheriff's Station	City of Industry	HS-LAS	W / D	6-10
207	780	LASD - Lakewood Sheriff's Station	Lakewood	HS-LAS	W / D	6-10
208	781	LASD - Lancaster Sheriff's Station	Lancaster	HS-LAS	W / D	6-10
209	790	LASD - Lomita Sheriff's Station	Lomita	HS-LAS	W / D	1-5
210	805	LASD - Lost Hills/Malibu Sheriff's Station-Agoura	Calabasas	HS-LAS	W / D	1-5

#	FCC ID	PSAP NAME	LOCATION	STATUS	TEXT	# OF POS RANGE
211	811	LASD - Marina Del Rey Sheriff's Station	Marina Del Rey	HS-LAS	W / D	1-5
212	8263	LASD - Metro Transportation Authority	Los Angeles	HS-LAS	W / D	1-5
213	849	LASD - Norwalk Sheriff's Station	Norwalk	HS-LAS	W / D	6-10
214	864	LASD - Palmdale Sheriff's Station	Palmdale	HS-LAS	W / D	1-5
215	872	LASD - Pico Rivera Sheriff's Station	Pico Rivera	HS-LAS	W / D	1-5
216	926	LASD - San Dimas Sheriff's Station	San Dimas	HS-LAS	W / D	1-5
217	955	LASD - Santa Clarita Valley Sheriff's Station	Valencia	HS-LAS	W / D	1-5
218	784	LASD - South Los Angeles Sheriff's Station	Los Angeles	HS-LAS	W / D	6-10
219	997	LASD - Temple City Sheriff's Station	Temple City	HS-LAS	W / D	6-10
220	1040	LASD - Walnut/Diamond Bar Sheriff's Station	Walnut	HS-LAS	W / D	1-5
221	1045	LASD - West Hollywood Sheriff's Station	Los Angeles	HS-LAS	W / D	1-5
222	782	Lassen County Sheriff's Department	Susanville	CP		1-5
223	785	Lincoln Police Department	Lincoln	HS-P		1-5
225	787	Livermore Police Department	Livermore		W / PD	1-5
226	788	Livingston Police Department	Livingston		I / PD	1-5
227	789	Lodi Police Department	Lodi			1-5
228	791	Lompoc Police Department	Lompoc			1-5
229	792	Long Beach Fire Department	Long Beach		W / D	6-10
230	794	Long Beach Police Department	Long Beach		W / D	11-29
231	796	Los Altos Police Department	Los Altos	HS-SC	I / PD	1-5
232	799	Los Angeles City Fire Department	Los Angeles		W / D	30+
233	797	Los Angeles County Fire	Los Angeles		W / D	11-29
234	800	Los Angeles Police Department	Los Angeles		W / D	30+
235	801	Los Banos Police Department	Los Banos		W / PD	1-5
236	802	Los Gatos Police Communications	Los Gatos		I / PD	1-5
237	803	Madera County Sheriff	Madera			1-5

#	FCC ID	PSAP NAME	LOCATION	STATUS	TEXT	# OF POS RANGE
238	804	Madera Police Department	Madera			1-5
239	806	Manteca Police Department	Manteca			1-5
240	808	Marin County Fire Department	Woodacre		I / PD	1-5
241	810	Marin County Sheriff's Department	San Rafael		I / PD	6-10
242	812	Mariposa County Sheriff's Department	Mariposa			1-5
243	813	Martinez Police Department	Martinez		W / D	1-5
244	814	Marysville Police Department	Marysville	CP		1-5
245	8264	McFarland Police Department	McFarland		W / PD	1-5
246	816	Mendocino County Sheriff's Department	Ukiah	HS-M	I / PD	6-10
247	817	Menlo Park Police Department	Menlo Park		W / D	1-5
248	819	Merced County Sheriff's Department	Merced		W / PD	1-5
249	820	Merced Emergency Medical Services	Merced		W / PD	1-5
250	821	Merced Police Department	Merced		W / PD	1-5
251	822	MetroNet - Metro Cities Fire Authority Comm. Center	Anaheim			6-10
252	825	Milpitas Police Department	Milpitas		I / PD	1-5
253	826	Modoc County Sheriff's Department	Alturas	CP		1-5
254	827	Mono County Sheriff's Department	Bridgeport			1-5
255	828	Monrovia Police Department	Monrovia		W / D	1-5
256	829	Montclair Police Department	Montclair		W / D	1-5
257	830	Montebello Police Department	Montebello		W / D	1-5
258	831	Montecito Fire Protection District	Montecito			1-5
259	835	Monterey County Emergency Communications	Salinas		W / D	11-29
260	834	Monterey Park Police/Fire Department	Monterey Park		W / PD	6-10
261	836	Morgan Hill Police Communications	Morgan Hill			1-5
262	838	Mountain View Police/Fire Department	Mountain View	HS-SC	I / PD	1-5
263	839	Mt. Shasta Police Department	Mt Shasta	CP		1-5
264	840	Murrieta Police Department	Murrieta			6-10

#	FCC ID	PSAP NAME	LOCATION	STATUS	TEXT	# OF POS RANGE
265	841	Napa County Communications	Napa			6-10
266	8126	NASA AMES Police Department	Moffett Field			1-5
267	842	National City Police Department	National City			1-5
268	844	Nevada County Sheriff's Department	Nevada City		I / PD	1-5
269	846	Newark Police/Fire Department	Newark			1-5
270	847	Newport Beach Police Department	Newport Beach			6-10
271	887	North County Dispatch	Rancho Santa Fe			6-10
272	850	Novato Police Department	Novato			1-5
273	851	Oakdale Police Department	Oakdale			1-5
274	852	Oakland Fire Department	Oakland			6-10
275	853	Oakland Police Department	Oakland			11-29
276	854	Oceanside Police Department	Oceanside			6-10
277	8479	Ontario Fire Department	Ontario		W / D	6-10
278	856	Ontario Police Department	Ontario		W / D	11-29
279	857	Orange County Fire Authority	Irvine			6-10
280	8257	Orange County Sheriff (Harbor Patrol/Newport Beach)	Corona Del Mar			1-5
281	858	Orange County Sheriff's Department	Silverado			11-29
282	859	Orange Police Department	Orange			6-10
283	860	Oroville Police Department	Oroville	CP, HS-B	I / D	1-5
284	861	Oxnard Police/Fire Department	Oxnard	HS-V		6-10
285	863	Palm Springs Police/Fire Department	Palm Springs		W / D	6-10
286	865	Palo Alto Police Department	Palo Alto	HS-SC	I / PD	6-10
287	866	Palos Verdes Estates Police/Fire Dept.	Palos Verdes		W / D	1-5
288	867	Paradise Police Department	Paradise	CP, HS-B	I / D	1-5
289	868	Pasadena Police Department	Pasadena	EE,CP	W / D	6-10
290	869	Paso Robles Police Department	Paso Robles		W / D	1-5
291	871	Petaluma Police Department	Petaluma			1-5

#	FCC ID	PSAP NAME	LOCATION	STATUS	TEXT	# OF POS RANGE
292	873	Piedmont Police Department	Piedmont			1-5
293	874	Pinole Police Department	Pinole		W / PD	1-5
294	875	Pismo Beach Police Department	Pismo Beach		W / D	1-5
295	876	Placentia Police Department	Placentia			1-5
296	877	Placer County Sheriff's Department	Auburn	HS-P		6-10
297	7957	Placerville Police Department	Placerville		W / PD	1-5
298	879	Pleasant Hill Police Department	Pleasant Hill		W / PD	1-5
299	880	Pleasanton Police Department	Pleasanton			1-5
300	881	Plumas County Sheriff's Department	Quincy	CP		1-5
301	882	Pomona Police Department	Pomona		W / D	6-10
302	883	Port Hueneme Police Department	Port Hueneme			1-5
303	885	Porterville Police Department	Porterville			1-5
304	888	Red Bluff Police Department	Red Bluff	CP	I / PD	1-5
305	889	Redlands Police Department	Redlands		W / D	6-10
306	891	Redondo Beach Police/Fire Department	Redondo Beach		W / D	1-5
307	892	Redwood City Police Department	Redwood City		W / D	6-10
308	893	Reedley Police Department	Reedley			1-5
309	895	Rialto Police Department	Rialto		W / D	6-10
310	897	Richmond Police Department	Richmond		W / D	6-10
311	898	Ridgecrest Police Department	Ridgecrest		W / PD	1-5
312	899	Ripon Police Department	Ripon			1-5
313	8120	Riverside County Sheriff's Department	Blythe	HS-R		1-5
314	8121	Riverside County Sheriff's Department	Palm Desert	HS-R		6-10
315	900	Riverside County Sheriff's Department	Riverside	HS-R		11-29
316	901	Riverside Police Department	Riverside		W / PD	11-29
317	902	Rocklin Police Department	Rocklin	HS-P		1-5
318	903	Rohnert Park Police Department	Rohnert Park			1-5
319	904	Roseville Police Department	Roseville	HS-P		6-10

#	FCC ID	PSAP NAME	LOCATION	STATUS	TEXT	# OF POS RANGE
320	906	Sacramento City Police Department	Sacramento		W / PD	11-29
321	905	Sacramento County Sheriff's Department	Elk Grove		W / PD	11-29
322	907	Sacramento Regional Fire Emergency Comm. Center - SRFECC	Sacramento			11-29
323	912	San Bernardino County Sheriff Dept.-Rialto/Valley	Rialto		W / D	11-29
324	915	San Bernardino County Sheriff's Department (Victorville/Desert)	Hesperia		W / D	11-29
325	917	San Bernardino Police Department	San Bernardino		W / D	11-29
326	918	San Bruno Police Department	San Bruno		W / D	1-5
327	922	San Diego County Lifeguards	San Diego			1-5
328	923	San Diego County Sheriff's Department	San Diego			11-29
329	924	San Diego Fire Communications/Metro Zone Command	San Diego			11-29
330	8258	San Diego Harbor Police Department	San Diego			1-5
331	925	San Diego Police Department	San Diego			30+
332	927	San Fernando Police Department	San Fernando	EE,CP	W / D	1-5
333	588	San Francisco Dept. Emergency Management	San Francisco		I / PD	30+
334	8125	San Francisco International Airport Police	South San Francisco		W / PD	1-5
335	931	San Gabriel Police Department	San Gabriel	EE,CP	W / D	1-5
336	933	San Joaquin County Sheriff's Department (Stockton/French Camp)	French Camp		W / PD	6-10
337	935	San Jose Police/Fire Communications	San Jose		W / PD	30+
338	936	San Leandro Police Department	San Leandro			6-10
339	937	San Luis Obispo County Sheriff's Department	San Luis Obispo		W / D	6-10

#	FCC ID	PSAP NAME	LOCATION	STATUS	TEXT	# OF POS RANGE
340	938	San Luis Obispo Police Department	San Luis Obispo		W / D	1-5
341	939	San Marino Police Department	San Marino		W / D	1-5
342	940	San Mateo County Communications	Redwood City			6-10
343	941	San Mateo Police Department	San Mateo		W / D	1-5
344	944	San Rafael Police Department	San Rafael			1-5
345	945	San Ramon Valley Fire Protection District	San Ramon		W / PD	1-5
346	948	Santa Ana Police Department	Santa Ana			11-29
347	950	Santa Barbara County Sheriff's Department	Santa Barbara		W / PD	6-10
348	951	Santa Barbara Police Department	Santa Barbara		W / PD	6-10
349	952	Santa Clara County Sheriff's Department Comm	San Jose			6-10
350	954	Santa Clara Police Department	Santa Clara		W / D	6-10
351	956	Santa Cruz Regional 9-1-1	Santa Cruz		W / D	11-29
352	958	Santa Maria Police Department	Santa Maria			6-10
353	960	Santa Monica Police Department	Santa Monica		W / D	11-29
354	961	Santa Paula Police Department	Santa Paula			1-5
355	962	Santa Rosa Police Department	Santa Rosa			6-10
356	964	Scotts Valley Police Department	Scotts Valley		I / PD	1-5
357	965	Sebastopol Police Department	Sebastopol			1-5
358	966	Selma Police Department	Selma			1-5
359	968	Shafter Police Department	Shafter		W / PD	1-5
360	969	Shasta County Comm. Center - SHASCOM	Redding	CP	W / PD	6-10
361	971	Sierra County Sheriff's Department	Downieville	CP		1-5
362	972	Sierra Madre Police/Fire Department	Sierra Madre	EE,CP	W / D	1-5
363	973	Signal Hill Police Department	Signal Hill		W / D	1-5

#	FCC ID	PSAP NAME	LOCATION	STATUS	TEXT	# OF POS RANGE
364	974	Simi Valley Police Department	Simi Valley	HS-V	W / PD	1-5
365	975	Siskiyou County Sheriff's Department	Yreka			1-5
366	976	Solano County Sheriff	Fairfield			6-10
367	8259	Sonoma County REDCOM Fire & EMS	Santa Rosa			6-10
368	977	Sonoma County Sheriff's Department	Santa Rosa			6-10
369	979	Sonora Police Department	Sonora			1-5
370	980	South Bay Regional Public Comm. Authority	Hawthorne		W / D	6-10
371	981	South Gate Police Department	South Gate		W / D	6-10
372	983	South Lake Tahoe Police Department	South Lake Tahoe			1-5
373	984	South Pasadena Police/Fire Department	South Pasadena		W / D	1-5
374	985	South San Francisco Police Department	South San Francisco		I / D	6-10
375	986	St. Helena Police Department	St. Helena			1-5
376	988	Stanislaus Regional 9-1-1	Modesto			11-29
377	8260	Stockton Fire Department	Stockton			6-10
378	989	Stockton Police Department	Stockton		W / PD	11-29
379	990	Suisun City Police Department	Suisun		I / PD	1-5
380	991	Sunnyvale Police Department	Sunnyvale		W / D	6-10
381	993	Sutter County Sheriff's Department	Yuba City	CP		1-5
382	994	Taft Police Department	Taft		W / PD	1-5
383	996	Tehama County Sheriff's Department	Red Bluff	CP		1-5
384	1000	Torrance Police Department	Torrance		W / D	11-29
385	1001	Tracy Police Department	Tracy			1-5
386	1003	Trinity County Sheriff's Department	Weaverville	CP		1-5
387	8261	Tulare County Consolidated Ambulance Dispatch - TCCAD	Tulare			1-5
388	8262	Tulare County Fire Department	Farmersville			1-5
389	1005	Tulare County Sheriff's Department	Visalia			11-29
390	1006	Tulare Police Department	Tulare			6-10

#	FCC ID	PSAP NAME	LOCATION	STATUS	TEXT	# OF POS RANGE
391	1008	Tuolumne County Sheriff's Department	Sonora		I / PD	1-5
392	1009	Turlock Police Department	Turlock			6-10
393	1010	Tustin Police Department	Tustin			1-5
394	1012	UC Berkeley Police Department	Berkeley			1-5
395	1013	UC Davis Police Department	Davis		W / PD	1-5
396	1014	UC Irvine Police Department	Irvine			1-5
397	1015	UC Los Angeles Police Department	Los Angeles		W / D	1-5
398	8173	UC Merced Police Department	Merced		W / PD	1-5
399	1016	UC Riverside Police Department	Riverside		W / PD	1-5
400	1017	UC San Diego Police Department	La Jolla			1-5
401	1018	UC San Francisco Police Department	San Francisco			1-5
402	1019	UC Santa Barbara Police Department	Santa Barbara		W / PD	1-5
403	1020	UC Santa Cruz Police Department	Santa Cruz			1-5
404	1021	Ukiah Police Department	Ukiah	HS-M	I / PD	1-5
405	1023	Upland Police Department	Upland		W / D	6-10
406	549	US Air Force Beale AFB SFCC	Beale AFB			1-5
407	700	US Air Force Edwards AFB Fire Department	Edwards AFB		W / PD	1-5
408	1002	US Air Force Travis AFB	Travis AFB			1-5
409	1031	US Air Force Vandenberg AFB Police/Fire Dept.	Vandenberg AFB		W / PD	1-5
410	734	US Army Fort Hunter Liggett Police Department	Ft Hunter Liggett		W / D	1-5
411	736	US Army Fort Irwin Provost Marshall (MP)	Fort Irwin			1-5
412	886	US Army Presidio of Monterey Dispatch Center	Presidio of Monterey		W / D	1-5
413	1025	US Park Police Golden Gate NRA	San Francisco			1-5
414	967	US Sequoia National Park	Three Rivers			1-5
415	1053	US Yosemite National Park	El Portal			1-5
416	580	USMC Camp Pendleton JECC	Camp Pendleton			1-5

#	FCC ID	PSAP NAME	LOCATION	STATUS	TEXT	# OF POS RANGE
417	8075	USMC Logistics Base Barstow - NEBO Provost Marshall	Barstow			1-5
418	8123	USMC Miramar Air Station Police/Fire Dept.	San Diego			1-5
419	1027	USMC Twenty-Nine Palms Combat Center - Fire	Twenty-Nine Palms			1-5
420	1029	Vacaville Police Department	Vacaville			6-10
421	1030	Vallejo Police Department	Vallejo			6-10
422	987	Valley Regional Emergency Comm Center	Modesto			11-29
423	1033	Ventura County Fire Protection District	Camarillo			6-10
424	1032	Ventura County Sheriff's Department	Ventura	HS-V		6-10
425	1034	Ventura Police Department	Ventura			6-10
426	1035	Verdugo Fire Department	Glendale	EE,CP	W / D	6-10
427	1036	Vernon Police Department	Vernon		W / D	1-5
428	1038	Visalia Police Department	Visalia			6-10
429	1039	Walnut Creek Police Department	Walnut Creek		W / PD	1-5
430	1042	Weed Police Department	Weed	CP		1-5
431	1044	West Covina Police/Fire Department	West Covina	EP,CP	W / D	1-5
432	1043	WEST-COMM - West Cities Police Comm Center	Seal Beach			6-10
433	1046	Westminster Police Department	Westminster			6-10
434	1047	Whittier Police Department	Whittier		W / PD	1-5
435	1048	Willits Police Department	Willits	HS-M	I / PD	1-5
436	1035	Willows Fire Department	Willows	CP		1-5
437	1051	Yolo Emergency Communications Agency YECA	Woodland		W / PD	6-10
438	1054	Yreka Police Department	Yreka	CP		1-5
439	1055	Yuba City Police Department	Yuba City	CP	I / PD	1-5
440	1056	Yuba County Sheriff's Department	Marysville	CP		1-5

*Updated PSAP tables will be provided to the Contractor upon contract execution.

Blank – CPE Stand-Alone
 HS – CPE Host-Remote System
 HS – B (Butte)
 HS – I (Imperial)
 HS – LAS (Los Angeles Sheriff)
 HS – P (Placerville)
 HS – R (Riverside)

HS – SC (Santa Clara)
 HS – V (Ventura)
 CE – Core Existing
 CP – Core Planned
 EE – Evergreen Existing
 EP – Evergreen Planned

W / D – Text Existing Web Based Service Deployed
 I / D – Text Existing Integrated Service Deployed
 W / PD – Text Planned or Pending Web Based Deployment
 I / PD – Text Planned or Pending Integrated Deployment

Table 1: Statewide Overview

Number of PSAPs¹	440
Total Population²	39,536,653
2017 Total 9-1-1 Call Volume³	28,129,927
Average Monthly 9-1-1 Call Volume⁴	2,319,585
2017 Busiest Month 9-1-1 Call Volume⁵	2,840,116
Average Busy Hour 9-1-1 Call Volume⁶	4,751
2017 Busiest Hour 9-1-1 Call Volume⁷	36,736
Average Call Duration in Seconds⁸	99.94

¹ Data updated February 2019, will be 438 as of April 1, 2019

² U.S. Census Bureau, Population estimates, July 1, 2017

³ Source: Cal OES Official Published Call Statistics in 2017 (include CHP Golden Gate 2016 counts due to long term outage in 2017)

⁴ Statewide sum total of the average 2017 monthly call volume for each PSAP

⁵ Statewide sum total of the 2017 busiest month call volume for each PSAP

⁶ Statewide sum total of the average 2017 busy hour call volume for each PSAP

⁷ Statewide sum total of the 2017 busiest hour call volume for each PSAP

⁸ Statewide average of the 2017 9-1-1 average call duration for each PSAP

Table 2: Average Region Overview

Average Number of PSAPs⁹	110
Average Total Population¹⁰	9,499,970
Average 2017 Total 9-1-1 Call Volume¹¹	6,711,175
Average 2017 Monthly 9-1-1 Call Volume¹²	579,896
Average 2017 Busiest Month 9-1-1 Call Volume¹³	710,029
Average Busy Hour 9-1-1 Call Volume¹⁴	1,188
Average 2017 Busiest Hour 9-1-1 Call Volume¹⁵	9,184
Average Call Duration in Seconds¹⁶	100

⁹ Data updated February 2019, Largest Region has 163, smallest is 79.

¹⁰ U.S. Census Bureau, Population estimates, July 1, 2017

¹¹ Source: Cal OES Official Published Call Statistics in 2017 (include CHP Golden Gate 2016 counts due to long term outage in 2017)

¹² Average of regions, sum total of the average 2017 monthly call volume for each PSAP

¹³ Average of regions, sum total of the 2017 busiest month call volume for each PSAP

¹⁴ Region average, sum total of the average 2017 busy hour call volume for each PSAP

¹⁵ Region average, sum total of the 2017 busiest hour call volume for each PSAP

¹⁶ Region average, average of the 2017 9-1-1 average call duration for each PSAP

SOW - ATTACHMENT 4a – NG9-1-1 PRIME FUNCTIONS AND SERVICES ACCEPTANCE AND AUTHORIZATION TEMPLATE

This document is a template that will serve as a starting point to develop a checklist that shall serve as notice from CA 9-1-1 Branch to the Contractor that the NG Prime Functions and Services are acceptable, as stated below and the Contractor may invoice CA 9-1-1 Branch.

All Information to be completed by the Contractor only
CA 9-1-1 Branch

Initial

- NG Text to 9-1-1 – Web Based OTT _____
- NG Text to 9-1-1 – Integrated _____
- Legacy PSAP Gateway _____
- Independent Verification & Validation _____
- Regional Interoperability Connection _____
- PSAP Integration _____
- Performance Reporting _____
- Call Logging _____
- Statewide Outage Reporting _____
- NRC Project Initiation and Design _____
- Statewide 911 GIS _____
- Selective Routing – as a standalone service _____
- GIS Data synchronization _____
- Alert and Warning System _____

Minor Discrepancies:

As the authorized representative of:

_____ (CA 9-1-1 Branch NG9-1-1 Manager),
I hereby acknowledge receipt, installation and satisfactory performance of the service.
If minor discrepancies exist, but do not keep the service from performing in accordance
with the contracted terms and conditions, these discrepancies are noted above.

AUTHORIZED BY:

Signature

Date

Printed/Typed Name

Title

IMMEDIATELY AFTER ACCEPTANCE

File a scanned copy to the CA 9-1-1 Branch NG9-1-1 Manager

SOW - ATTACHMENT 4b –NG9-1-1 TRUNKS ACCEPTANCE AND AUTHORIZATION TEMPLATE

This document is a template that will serve as a starting point to develop a checklist that shall serve as notice from CA 9-1-1 Branch to the Contractor, that the NG Prime/Region Trunk services are acceptable, as stated below, and the Contractor may invoice CA 9-1-1 Branch.

All Information to be completed by Contractor only

CA 9-1-1 Branch

Initial

- Trunks from Prime to PSAP _____
- Capacity tested 1Mb _____
- Capacity tested 10Mb _____
- Capacity tested 100Mb _____
- Capacity tested 1000Mb _____

- _____ tested _____
- Trunk failover tested _____

Minor Discrepancies:

As the authorized representative of:

_____ (CA 9-1-1 Branch NG9-1-1 Manager),
I hereby acknowledge receipt, installation and satisfactory performance of the service.
If minor discrepancies exist, but do not keep the service from performing in accordance
with the contracted terms and conditions, these discrepancies are noted above.

AUTHORIZED BY:

Signature

Date

Printed/Typed Name

Title

IMMEDIATELY AFTER ACCEPTANCE

File a scanned copy to the CA 9-1-1 Branch NG9-1-1 Manager

**SOW - ATTACHMENT 4c – NG9-1-1 AGGREGATION ACCEPTANCE AND AUTHORIZATION
TEMPLATE**

This document is a template that will serve as a starting point to develop a checklist that shall serve as notice from CA 9-1-1 Branch to the Contractor, that the NG9-1-1 Aggregation services are acceptable, as stated below, and the Contractor may invoice CA 9-1-1 Branch.

All Information to be completed by Contractor only
CA 9-1-1 Branch

Initial

- Able to accurately aggregate all Text OSPs (PNSP) _____
- Able to accurately accept aggregation (# of aggregations) _____
- Able to failover if one aggregation is offline _____
- Able to transfer all 9-1-1 call modalities to Prime and Region _____

Minor Discrepancies:

As the authorized representative of:

_____ (CA 9-1-1 Branch NG9-1-1 Manager),
I hereby acknowledge receipt, installation and satisfactory performance of the service.
If minor discrepancies exist, but do not keep the service from performing in accordance
with the contracted terms and conditions, these discrepancies are noted above.

AUTHORIZED BY:

Signature

Date

Printed/Typed Name

Title

IMMEDIATELY AFTER ACCEPTANCE

File a scanned copy to the CA 9-1-1 Branch NG9-1-1 Manager

**SOW - ATTACHMENT 4d –NG CORE SERVICES ACCEPTANCE AND AUTHORIZATION
TEMPLATE**

This document is a template that will serve as a starting point to develop a checklist that shall serve as notice from CA 9-1-1 Branch to the Contractor, that the Prime NG Core Services are acceptable, as stated below, and the Contractor may invoice CA 9-1-1 Branch.

All Information to be completed by Contractor only

CA 9-1-1 Branch

Initial

- Able to accurately route 9-1-1 calls _____
- Able to receive all 9-1-1 call modalities _____
- _____
- Able to transfer all 9-1-1 call modalities _____
- Received training of NG Prime Core 9-1-1 service _____
- Received training to access NG Prime Core call data _____
- _____
- Can access and understand NG Prime administrative tools _____

Minor Discrepancies:

As the authorized representative of:

_____ (CA 9-1-1 Branch NG9-1-1 Manager),

I hereby acknowledge receipt, installation and satisfactory performance of the service.

If minor discrepancies exist, but do not keep the service from performing in accordance with the contracted terms and conditions, these discrepancies are noted above.

AUTHORIZED BY:

Signature

Date

Printed/Typed Name

Title

IMMEDIATELY AFTER ACCEPTANCE

Submit a scanned copy to the CA 9-1-1 Branch NG9-1-1 Manager

**SOW - ATTACHMENT 4e – PRIME NG TEXT TO 9-1-1 ACCEPTANCE AND AUTHORIZATION
TEMPLATE**

This document is a template that will serve as a starting point to develop a checklist that shall serve as notice from CA 9-1-1 Branch to the Contractor, that the Prime NG Text to 9-1-1 Services are acceptable, as stated below, and the Contractor may invoice CA 9-1-1 Branch.

All Information to be completed by Contractor only

CA 9-1-1 Branch

Initial

- Able to receive NG Text to 9-1-1

- _____ Able to send NG Text to 9-1-1 _____
- _____ Able to transfer NG Text to 9-1-1 _____
- _____ Received training of NG Text to 9-1-1 service _____

- _____ Received training to access NG Text to 9-1-1 session data _____
- _____ Can access and understand Text administrative tools _____

- _____ Validate session data with NG Text to 9-1-1 reporting tool _____

Minor Discrepancies:

As the authorized representative of:

_____ (CA 9-1-1 Branch NG9-1-1 Manager),
I hereby acknowledge receipt, installation and satisfactory performance of the service.
If minor discrepancies exist, but do not keep the service from performing in accordance
with the contracted terms and conditions, these discrepancies are noted above.

AUTHORIZED BY:

Signature

Date

Printed/Typed Name

Title

IMMEDIATELY AFTER ACCEPTANCE

Submit a scanned copy to the CA 9-1-1 Branch NG9-1-1 Manager

SOW - ATTACHMENT 5a – ACCEPTANCE TESTING PLAN TEMPLATE

The Acceptance Test Plan template is attached in an Excel format.

Requirement Reference Number	Test Date and Duration	Test Results	Pass/Fail	Notes	Contractor signoff
1.1					
1.2					
1.3					

SOW - ATTACHMENT 5b – CERTIFICATE OF SYSTEM READINESS TEMPLATE

The Certificate of System Readiness Template is in Word format.

PRIME/REGION NETWORK SERVICE PROVIDER	PSAP NAME	TODAY'S DATE:
Start Date of System Acceptance:	End Date of System Acceptance:	
PNSP/RNSP Representative Name:	PNSP Representative Signature:	
PSAP Representative Name:	PSAP Representative Signature:	
CA 9-1-1 Branch Representative Name:	CA 9-1-1 Branch Representative Signature:	
<p>All of the above signed Representatives hereby acknowledge receipt, installation and satisfactory performance of the Next Generation 9-1-1 Services. This Certificate of System Readiness confirms the NG9-1-1 Services have successfully completed the 45 calendar day Acceptance Test Plan (ATP). Any discrepancies noted during the ATP shall be noted on the Final Test Report.</p>		

SOW - ATTACHMENT 6 – WORK ORDER AUTHORIZATION FORM

WOA Number: _____ Amendment: _____

Title of WOA: _____ Dates: _____

Work Description:

Tasks and Work Products:

Cost:

Not-to-Exceed Cost					
	Staff Name	Classification	Labor Hours	Rate Per Hour	Cost
1					
2					
				Not-to-Exceed Cost Total	

Acceptance Criteria:

State Responsibilities:

Approvals:

These tasks will be performed in accordance with this WOA including any accompanying documentation, if applicable and the provisions of the Contract.

State of California

Contractor

 Name Date

 Name Date

SOW - ATTACHMENT 7 – CONTRACTOR'S LICENSE INFORMATION

(Installation Services Only)

The Contractor shall obtain, at their own expense, all license(s) and permit(s) required by law for accomplishing any work required in connection with this contract. The Contractor shall complete the applicable contractor's license information below in accordance with the Contractor's State License Board, Department of Consumer Affairs. At a minimum, a California C-7 license is required prior to commencement of work which may include the installation of cable and wiring and electrical modification. Contractors or subcontractors performing cable and/or wiring installation work or structural modifications are required to have the appropriate State contractor's license. The license must be in the name of the company or the name of the "qualifying individual" of the company. It is the Contractor's responsibility to ensure that the Contractor and/or Subcontractor maintain a current CA C-7 license during the term of the contract and may be verified by the State at any time. The Contractor may not perform any work at or with a PSAP without valid license.

CONTRACTOR:

Class _____ License No: _____
Licensee: _____ Expiration Date: _____
Class _____ License No: _____
Licensee: _____ Expiration Date: _____

Note: Contractor (Firm's Name or a Responsible Managing Employee) must be licensed in addition to all subcontractor(s) performing under this contract.

SUBCONTRACTOR 1

Class _____ License No: _____
Licensee: _____ Expiration Date: _____
Relationship of Licensee to Contractor: _____

SUBCONTRACTOR 2

Class _____ License No: _____
Licensee: _____ Expiration Date: _____
Relationship of Licensee to Contractor: _____

SOW – ATTACHMENT 8 – PROJECT MILESTONE REPORT



Project Milestone Report

Project Name / Contract Number:		Prepared date/time:			
Project Start Date:	Project End Date:	% Complete:			
Cal OES Project Manager:		Contractor Project Manager:			
Milestone Name:		Milestone Due Date:			
Milestone Description:					
Cal OES Project Manager Name:		Contractor Project Manager Name:			
Cal OES Project Manager Signature:		Contractor Project Manager Signature:			
Agreement to Adjust Milestone Due Date					
		Adjusted Milestone Due Date:			
Approved by Cal OES Date:		Approved by Contractor Date:			
Cal OES Project Manager Name:		Contractor Project Manager Name:			
Cal OES Project Manager Signature:		Contractor Project Manager Signature:			
Reason for adjusted Milestone Due Date:					
Project Milestone Status:					
Green:	Yellow:	Red:			
Project Milestone is within scope, budget, and schedule.	Project milestone is at risk.	Project milestone is in danger			
Circle Project Milestone Status:					
Green	Yellow	Red			
Current Milestone Life Cycle Phase (Check one):					
Concept	Planning	Design	Test	Implement	Completed
Project Documentation		Resources		Services and Software	
<input type="checkbox"/> Not started		<input type="checkbox"/> Available		<input type="checkbox"/> No updates needed	
<input type="checkbox"/> In development		<input type="checkbox"/> Need to assess		<input type="checkbox"/> Software updates needed	
<input type="checkbox"/> Revision update		<input type="checkbox"/> Need to hire		<input type="checkbox"/> Under development	
<input type="checkbox"/> Sent for approval		<input type="checkbox"/> Release resource(s)		<input type="checkbox"/> Not applicable	
<input type="checkbox"/> Other (specify)_____		<input type="checkbox"/> Other (specify)_____		<input type="checkbox"/> Other (specify)_____	
Project Milestone Status: (This is an update of the current status for this Milestone)					
Project Milestone Risks: (These should include actions being taken or recommendations for mitigation.)					

SOW Attachment 9: GLOSSARY OF TERMS

Acronyms and Abbreviations

Term/Acronym	Definition
9-1-1 traffic	Includes all voice, data, text, pictures, videos, and any future technologies capable of delivering to PSAP over the NG9-1-1 Network.
Agency/State entity	Includes every state office, officer, department, division, bureau, board, and commission, including Constitutional Officers. "State entity" does not include the University of California, California State University, the State Compensation Insurance Fund, the Legislature, or the Legislative Data Center in the Legislative Counsel Bureau.
Aggregation	The services needed to receive 9-1-1 traffic from an OSP and deliver to the correct Core Service Provider.
Business Requirements	Higher-level statement of the goals, objectives, or needs of the Agency/state entity. Business requirements describe the reasons why a project has been initiated, the objective that the project will achieve, and the metrics that will be used to measure its success. Business requirements describe the needs of the Agency/state entity as a whole, not the groups or stakeholders within it.
Certificate of System Readiness Form	Contractor shall complete the acceptance test plan and authorization checklist as defined in the SOW Section 14.2 Acceptance Testing Criteria. The Certificate of System Readiness Form will be signed by the Contractor and approved by CA 9-1-1 Branch for the acknowledgement of satisfactory system performance.
Commercial Off The Shelf Software (COTS)	A computer hardware or software product that is ready-made for specific uses and available for sale to the general public. COTS products are designed to be installed without requiring custom development. For example, Microsoft Office is a COTS product that is a packaged software solution for businesses and individuals. The set of rules for COTS is defined by the Federal Acquisition Regulation (FAR).
Contractor	The bidder who is awarded the NG9-1-1 Services – Prime contract. Contractor may also be referenced as Prime Network Service Provider.
Custom solution	Typically, computer software developed for a specific customer to accommodate the customer's particular requirements, preferences, and expectations.

Term/Acronym	Definition
Dedicated	All components and software that are used to support NG9-1-1 traffic in California, must meet the requirements of this RFP and the needs of California at any instance in time.
Functional Requirements	Functional requirements represent the business objectives, needs and outcomes of all stakeholders. They should be organized and presented in context of and with a baseline business process/workflow that they describe. They provide a description of what an enabling solution should provide and specify essential details of a solution for stakeholders as a means to express and manage expectations. They describe actions and operations that the solution must be able to perform. They can describe services, reactions, and behaviors of the solution. They also describe information the solution will manage. The requirements should be expressed in business terms and should not include any technical references. The requirement should identify “what” is required to meet the business objective, not “how” the requirement will be implemented.
Modified Off The Shelf (MOTS)	MOTS product – Typically, a COTS product with source code made available to the purchaser to allow for modifications. The product may be customized by the purchaser, by a vendor, or by another party to meet the requirements of the customer. Since MOTS product specifications are written by external sources, purchasers may not have control of future changes to the product.
Non-functional Requirements	Non-functional requirements provide criteria to evaluate the operation of an enabling solution and primarily represent qualities of (expectations and characteristics) and constraints on (e.g., governmental regulations) the solution. They capture conditions that do not directly relate to the behavior or functionality of the solution, but rather describe environmental conditions of an effective solution or productive qualities of the solution. Mid-level non-functional requirements also define quality of service requirements, such as those relating to required capacity, speed, security, privacy, availability, response time, throughput, usability, and the information architecture and presentation of the user interfaces.
Point of Interface (POI)	Placed in a location that meets the needs of OSPs and provides the interfaces needed to accept 9-1-1 traffic from the OSP and deliver that traffic to aggregation over an NG9-1-1 trunk service.

Term/Acronym	Definition
Prime Network Service Provider	The bidder who is awarded the NG9-1-1 Services – Prime contract. The Prime Network Service Provider may also be referenced as the Contractor.
Project/Transitional Requirements	Project/transition requirements describe capabilities that the solution must have in order to facilitate the transition from the current state of the enterprise to a desired future state. Mid-level project/transition requirements are differentiated from other requirement types because they are usually temporary in nature and will not be needed once the transition is complete. They typically cover process requirements imposed through the contract, such as mandating a particular design method, administrative requirements, data conversion and migration from existing services, interfaces, skill gaps that must be addressed, and other related changes required to reach the desired future state.
Region	One of four areas in California, defined Northern Region (163 PSAPs and 7,492,162 Yearly number of calls); Central Region (110 PSAPs and 4,918,909 Yearly number of calls); Los Angeles Region (79 PSAPs and 8,514,105 Yearly number of calls); Southern Region (89 PSAPs, 6,929,512 Yearly number of calls)
Regional	A large scale 9-1-1 project that meets both of the following conditions: 1) More than on PSAP, or single PSAP that dispatch multiple agencies. 2) Has a total call volume of greater than 1,000,000 calls per year.
Solution Requirements	Describes the characteristics of a solution that will meet the business requirements. Solution requirements describe specific characteristics of the solution both in terms of functionality and quality of service. Solution requirements are sub-classified into functional requirements, non-functional requirements and project/transitional requirements.
Transitional/Project Requirements	Transition/ Project requirements describe capabilities that the solution must have in order to facilitate the transition from the current state of the enterprise to a desired future state. Mid-level project/transition requirements are differentiated from other requirement types because they are usually temporary in nature and will not be needed once the transition is complete. They typically cover process requirements imposed through the contract, such as mandating a particular design method, administrative requirements, data conversion and migration from existing services, interfaces, skill gaps that must be addressed, and other related changes required to reach the desired future state.

EXHIBIT 20: TECHNICAL REQUIREMENTS NARRATIVE RESPONSE

NGA 911, LLC

Exhibit 23: 23.0.0

Describe the key success factors for the RNSP and how the RNSP will measure, monitor, and ensure timely implementation of NG 9-1-1 services. The description must include challenges and mitigation strategies that impact the project's critical path, and how the RNSP will comply with project plans and interfaces set by the PNSP.

RESPONSE TO 23.0.0

The primary success factor is - “prepare the region for cut over to IP”; this is the mission that drives all tasks. To accomplish this mission all 9-1-1 traffic must ingress the TDM POI (or SIP Aggregation Point) and every PSAP must be capable of receiving IP in some manner which can include (i) direct into existing CPE, (ii) through upgrade of the CPE, or (iii) by installation of a Legacy PSAP Gateway “LPG”.

The greatest challenge to success is coordinating, educating, training, and obtaining PSAP buy-in. To mitigate this risk, NGA 911 will assign a dedicated Project Manager. The NGA 911 Project Manager has subject matter expertise, experience with California, and has proven trusted relationship with the County Coordinators, PSAPs, and Vendors through years of leadership in California, partnership with Cal OES on previous projects, and successful collaboration and execution of statewide implementations of Cal OES driven initiatives, i.e. Wireless Routing, Text to 9-1-1. The Project Manager assigned will coordinate with the PNSP and Cal OES to ensure PSAPs integration per PNSP/Cal OES best practices, integration with the PSAPs align with the Cal OES approved Interface and Integration Project Deployment Plan, and on schedule.

To ensure the timely implementation of the NG9-1-1 services the Project Manager will work with the PNSP and Cal OES to establish performance measurements, project milestones, and draft an approved Interface and Integration Project Deployment Plan. The Project Manager will monitor the status of each stage of implementation and provide reports to Cal OES and the Prime by attendance at weekly meetings providing coordination and all supporting project documentation for weekly NG9-1-1 Region Service meetings/updates with CA 9-1-1 Branch, updating the Project Milestone Report, and other additional reports as identified by Cal OES.

The overarching key success factors will lie in the involvement of key stakeholders including NGA 911, Cal OES, and the PNSP. This includes the following: (i) communication, collaboration, and a clear defined project plan and schedule between all stakeholders; (ii) RNSP will work with the PNSP at each PSAP, as directed by CA 9-1-1 Branch; (iii) RNSP will connect to Prime and comply with interoperability as directed by PNSP at the direction of CA 9-1-1 Branch; (iv) RNSP will utilize the PNSP defined and CA 9-1-1 Branch approved interface at aggregation, between regional and prime, at the PSAP and for all other interoperability interfaces.

NGA 911 has broken the RNSP critical tasks to success into three steps as follows: (1) Step one, Information Collection and Evaluation, (2) Step Two, Design and Plan for Transition, and (3) Step Three, Execute the Transition.

During the first step of “Information Collection and Evaluation” information will be collected through a combination of site survey, questionnaire results, reports from network service providers, and the CAPSNET availability update and then evaluated to determine each PSAPs readiness for IP and i3. Based on the results, the appropriate solution for each PSAP will be architected. Regarding the network architecture the following tasks must be performed: (1) placement of POIs; (2) placement of Aggregation Points; (3) design of the Region’s ESInet; and (4) evaluation of PSAP in the following areas: NG Trunks for call deliver, location delivery, call back number delivery, ALI integration or NG alternative, Rebid mechanism, and PSAP CPE readiness.

An essential aspect of the first step is to ensure consistent and meaningful naming conventions for ingress SS7 signaling and trunking to facilitate reporting, auditing, and accountability of 911 traffic. These naming conventions will be discussed, coordinated, and agreed upon by PNSP, RNSP, and Cal OES to ensure all accountability goals are achieved.

The challenges and risks to region readiness for IP cutover are as follows: (i) the ILECs could argue the POI location placement; (ii) the ILECs internal business processes may slow the deployment timeline; (iii) the wireless carriers, to a lesser degree than the ILECs, could push back and impede the process of POI placement and traffic

EXHIBIT 20: TECHNICAL REQUIREMENTS NARRATIVE RESPONSE

NGA 911, LLC

ingress, and (iv) the PSAPs typically lack technical skill and time so their focused collaboration will be a risk to the project. Mitigation strategies to reduce these risks include: (i) start an early dialogue with the ILEC on POI placement; (ii) work with Cal OES, PNSP, and CPUC to handle ILEC impacts on the deployment timeline; (iii) start early in the project and work in earnest and good faith with the wireless carriers on E911 or SIP traffic aggregation; (iv) be prepared to handhold the PSAPs through this challenging process. These elements of the risk mitigation strategy must be applied early and often to properly handle these challenges.

During the second step of “Design and Plan for Transition,” the POIs and Aggregation points are constructed, tested, and the PSAP is fully readied for IP cutover. During this second step testing and confirmation will show (i) wireline 911 traffic can be received with SS7 calling Party Number of MF ANI and delivered via an NG Trunk to the PSAP; (ii) legacy wireless E911 traffic can be delivered with an ESRK as the SS7 Calling Party number of MFANI, or with the Mobile Directory Number as the SS7 Calling party Number/ MF ANI and an ESRD/ESRK in the SS7 Generic Digits parameter/MF called number and delivered via an NG Trunk to the PSAP; (iii) that the 911 SIP traffic can be delivered either from the POI or direct to the Aggregation Point; (iv) that the NGCS residing within the ESInet has been properly configured to receive, deliver, organize, report, and handle all exceptions; (v) that the NG Trunks to every PSAP in the Region have been built out and tested to ensure call delivery, as well as region and prime reporting and monitoring; (vi) and, most importantly routing via the PNSP to the PSAP will be critical as this ensures the Selective Router’s limitations are removed from the call path.

During the second step, ensuring PSAP readiness presents a substantial challenge and risk to project success. PSAPs could experience discomfort as they are challenged to understand the impact to their operations and feel comfortable that all their considerations have been addressed, the following technology considerations must be addressed at the PSAP: (i) NG Trunks with routers in the PSAP will be installed with reporting and monitoring enabled; (ii) LPG will be installed where necessary; (iii) location delivery for wireless and wireline must be confirmed; (iv) the ALI replacement or translation must be confirmed; (v) and, Callback Number delivery must be confirmed.

Our mitigation strategy for challenges and risks of step two includes factoring in substantial training, communication, and hand holding during this PSAP readiness phase of the project. Additionally, our mitigation strategy includes creating a “PSAP Feedback Loop” that will enable real-time feedback and handling of all PSAP considerations during both the planning and cutover phases of the project.

The final step is “Execute the Transition” and flip the switch on the IP cutover. Success of this phase will be determined by (i) communicating, handling, and collaborating on all exceptions and issues as they are presented; (ii) monitoring all feedback loops to proactively handle considerations with the IP cut over.

The loudest voice, and the greatest challenge and risk, after IP cutover will be the PSAP. Our “PSAP Feedback Loop” will provide an outlet for their voices to be heard and acknowledged, and their considerations handled. PSAPs will receive assistance via voice, email, and instant message with assurance that EVERY issue will be handled with transparency and to completion. It is important to note that since California will no longer be hamstrung by the legacy network that we expect delivery of exceptional service can be delivered to PSAPs in a manner that is UNPRECEDENTED in the state, and that every issue with the IP network can be solved expeditiously through close cooperation and coordination between the RNSP, PNSP, and Cal OES.

EXHIBIT 20: TECHNICAL REQUIREMENTS NARRATIVE RESPONSE
NGA 911, LLC

Exhibit 23: 23.0.1

Proven Ability: First, the RNSP must have the proven capacity to handle the regional call volume. NGA 911 exceeds this requirement since it has already proven its ability to process large call volumes at a moment's notice for a population of 500,000,000 with 300,000,000 calls per year which far exceeds the requirements of the State of California. Tests were conducted per [REDACTED]

The tests had the following load:

- Population: 500,000,000
- Call per Year: 300,000,000
- Number of PSAPs: 4,400
- Dispatchers: 18,000
- Phones: 3,600
- Average Call Duration: 120s
- Minimum Call Duration: 10s
- Maximum Call Duration: 600s

Under heavy load the system demonstrated vertical scaling, process distribution, and horizontal scaling with zero error.

Consistent with NGA 911's transparency policy, these tests can be conducted with our Cal OES partner prior to award of contract.

Routing Options

In order to route a call, the RNSP requires a location in some form and by some method. NGCS supports the various location formats and both the SIP or HTTP methods by which location is delivered. Routing of 9-1-1 traffic can be accomplished by plotting the lat/lon inside a shapefile, or with the equivalent of tower/sector routing - both options are required during the transition period. While RNSP will be responsible to ensure all locations will be associated with a latitude and longitude for subsequent processing by the Location-to-Service Translation Protocol, some calls will not have a location that can be associated with a latitude and longitude, subsequently they will be routed based on the current routing methodology i.e. fixed routing through the use of an LDB or routed to a default Call Center for manual processing.

PNSP routing to RNSP

The PNSP is responsible for aggregating some of the OSPs (Small LEC and VoIP), all Text-to-911 (including RTT), and is the 'hot-standby' for all the Wireless OSPs. This means that significant traffic will be directed (routed) from the PNSP to NGA 911's RNSP. The PNSP through its ESRP will obtain the routing URI (LoST) which in this case will resolve to the RNSP ESRP for further processing. The RNSP will then evaluate the SIP Header to determine the PSAP endpoint URI to complete the call routing.

PSAP Inter-Regional Transfers

The PNSP is responsible for handling all inter-Regional transfers. In accordance with NENA i3, the RNSP NGCS ESRP/PRF will be configured to receive transfers originating from a PSAP in another Region through the PNSP using the SIP REFER method together with a Replaces header as part of a transfer operation to the serving ESRP. The request will be forwarded to the RNSP ESRP for routing within the RNSP. The Regional ESRP and the Prime ESRP are connected to each other through a BCF-

EXHIBIT 20: TECHNICAL REQUIREMENTS NARRATIVE RESPONSE NGA 911, LLC

to-BCF interface and are known to each other through their Credentialing Authority (CA) issued certificates.

Location Database

NGA 911's NGCS is capable of leveraging California's GIS Database to create an LDB that will provide consistent and accurate location information that is essential for non-geodetic call routing.

An LDB serves as both a legacy ALI database and as a LIS in an NG9-1-1 environment. The LDB retains all current information, functionality, and interfaces of today's ALI, but also can utilize the new protocols required in an NG9-1-1 deployment. The LDB supports the protocols for legacy ALI query and ALI query service, the protocols required to obtain information for wireless calls by querying the mobile positioning center (MPC) or gateway mobile location center (GMLC), and the protocols required for location information retrieval and conveyance, such as HTTP-Enabled Location Delivery (HELD) or other proprietary protocols.

Location-to-Service Translation Protocol (LoST)

NGA 911's ECRF can utilize the statewide GIS database that is maintained and updated by the Next Generation 9-1-1 (NG9-1-1) Prime vendor for routing all 9-1-1 traffic. Alternatively, the NGA 911, as the RNSP, can provide its own ECRF. Regardless whether a PNSP or RNSP ECRF, the RNSP expects to send LoST requests to the ECRF in the form of HTTP type employed in the original request (e.g. **POST**) with a Content-Type of application/lost+xml. LoST responses to the RNSP from the PNSP, including those indicating warning(s) or error(s), are carried in HTTP 2xx responses, typically 200 (OK).

LoST Protocol is fully documented in RFC 5222: <https://tools.ietf.org/html/rfc5222>

The RNSP expects the availability of the following API methods:

- FindService: Performs Emergency Call Routing Function (ECRF) and/or Location Validation Function (LVF) in order to map civic and/or geodetic locations to contact Uniform Resource Identifier (URI)s and associated data and/or validate location data.
- FindServiceECRF: Performs ECRF in order to map civic and/or geodetic locations to contact URIs and associated data.
- FindServiceLVF: Performs LVF in order to validate location data.
- GetServiceBoundary: Obtains and returns a service boundary given a globally Unique Service Boundary (USB) identifier.
- ListServiceContactsByLocation: Obtains and returns a serviceContactList element containing a collection of serviceContact elements. These serviceContact elements contain the displayName, uri, serviceNumber, and service of an agency.
- ListServices: Obtains and returns a list of supported services.
- ListServicesByLocation: Obtains and returns a list of supported services for a particular location.

EXHIBIT 20: TECHNICAL REQUIREMENTS NARRATIVE RESPONSE
NGA 911, LLC

Exhibit 23: 23.0.2

Describe the process to route any 9-1-1 traffic to the Prime when the awarded region is unable to deliver the call to the correct PSAP. Description should include how this function will be supported when there is a complete loss of awarded region NG 9-1-1 services, and when the correct PSAP is not directly connected to the awarded region, and when the correct PSAP is connected to the awarded region, but is unreachable due to network or transport outage.

Response:

Technology to route any 9-1-1 traffic to the Prime:



Below are a number of points in the RNSP that if a routing or network failure occurs, the Prime (PNSP) will take over call routing: in the network level Emergency Services IP network (ESInet), at the POI, at the Aggregation Point(s) (AP), in the Next Generation Core Services (NGCS), or the connectivity to or at the PSAP. Each circumstance can result in a different response from the RNSP and the PNSP.

Following are system failure scenarios RNSP must handle along with where the failure would occur and the call anchoring point for handling the failure:

1. If the PSAP is not reachable, but the Regional NGCS is functioning – the NMS updates Policy Store and the call is routed by the Regional ESRP to the Prime ESRP. This failure could occur at the NG Trunk to the PSAP or the PSAP itself; the call would be anchored at the Region Aggregation Service. Additionally, and as designated by the PNSP, the RNSP could handle intra-region PSAP failures by routing to the designated backup PSAP. (Diagram 23.0.2.1)
2. If the PSAP is not reachable because the Regional NGCS is not functioning – the call is routed to the Prime BCF. In this case, the call successfully passed through the POI and reached the RNSP Aggregation Point where the call is anchored. (Diagram 23.0.2.2)
3. If the correct PSAP is not reachable because the aggregation points in the Region are down, then the call routes to the failover Aggregation Point. In this case, the call is egressing the POI and has passed through the LNG, so it has been converted to SIP; the call is anchored at the LNG. (Diagram 23.0.2.3)
4. If the correct PSAP is not reachable because the ESInet in the Region is down; and there is of services it at the Prime (e.g. Wireless ‘Hot-standby’) then the call ingresses the Prime ESInet directly; the call would be anchored to the PNSP Aggregation Service.
5. If the PSAP is reachable, but the PSAP’s CPE is unable to acknowledge the call successfully, the call could route to the backup PSAP by the RNSP, or to the PNSP depending on the routing rules published by the PNSP; the call would be anchored at the Region Aggregation Service.

When the correct PSAP is not directly connected to the awarded region, then such a call is directed to the Prime through the Regional ESRP/PRF after it queries the ECRF which returns a ‘last-hop’ outside the Region (Diagram 23.0.2.4).

When the correct PSAP is a member of the Region but is not reachable due to network or transport outage – that outage will be known by the PRF and the call directed over the Prime (see 23.0.2.1).

EXHIBIT 20: TECHNICAL REQUIREMENTS NARRATIVE RESPONSE

NGA 911, LLC

Monitoring and Handling of RNSP Failures

The instances described below depend on where the failure is in the network, which functional elements are impacted or if the correct PSAP is not in the Region. For failures it is the Network Operations Center (NOC), Security Operations Center (SOC), and supporting Network Management Systems (NMS), collectively the Operating Support Systems (OSS), that detect and react to the failure or failures that impact PSAP availability. One such failure is network connectivity to the PSAP, i.e., **PSAP is connected to the awarded region, but is unreachable due to network or transport outage**. NGA 911's solution rests on a comprehensive OSS and a defense in depth security monitoring system e-bonded with the PNSP OSS which has integrated availability response with our service realization Quality Management System (QMS). In the case of a PSAP that is available but out of Region, it is the PRF that directs the call to Prime ESRP. In all of the above cases it is the Policy Routing Rules (PRR), first as available from the Policy Store and second as default PRRs that facilitate any rerouting of calls to the correct PSAP.

Complete Loss of Awarded Region NG9-1-1 Services - ESInet Failure

For the case where the ESInet for the Region is completely down and not reachable through the Border Control Function (BCF) interface, the PNSP will handle all calls for that Region. The reasons that an ESInet may fail could be due to a security breach, persistent or intermittent network disruptions, catastrophic failures, etc. It is incumbent on the PNSP through the monitoring systems and the NOC to immediately identify and respond to a Regional ESInet failure. OSP traffic aggregated in the Region will automatically and immediately route to the PNSP through the PNSP BCF gateways at the Regional AP if still functioning. If the Regional Aggregation Points serving the downed ESInet are incapacitated, OSP traffic will be routed to the PNSP from the backup AP in the neighboring Region. OSP traffic that is already served by the PNSP (Small LEC, Text, and VoIP OSPs) are not impacted in this scenario and are handled by the PNSP as usual.

Regional NGCS Failure

A failure of the RNSP NGCS is handled similarly to the method described for the ESInet failure. The Aggregation Point in the Region will direct OSP traffic to the PNSP for handling.

Aggregation Point (AP) Failure

If both Aggregation Points in a Region fail then the 9-1-1 call is stuck at the POI, OSP calls destined for that Region are serviced by the designated PSNP backup Aggregation Point. With proper trunk naming conventions, the call can be handled more intelligently and with proper service. NGA 911 proposes that in the case where there is a failure to receive proper location information at the Aggregation Point, most likely CHP (default route) processes the call using the established trunk naming convention to determine caller location and then forward to the correct PSAP via the correct NGCS.

PSAP Failure

The nature of a failure at a PSAP will influence the handling of the emergency traffic. If the PSAP within a Region fails and is not reachable by either RNSP or the PNSP, and its backup PSAPs are within the same Region; then either the RNSP or PNSP could redirect calls based on the mutually agreed upon Regional Policy Routing Function (PRF) Policy Routing Rules (PRR) settings in the Emergency Services Routing Proxy (ESRP) to the appropriate backup PSAP or PSAPs for further handling. If the failed PSAP has backup PSAPs that are outside the Region, the PNSP ESRP/PRF be activated when calls are directed to inter-Regional PSAPs in a manner similar to normal inter-Regional transfers as described below.

PSAP Inter-Regional Transfers

The PNSP is responsible for handling all inter-Regional transfers via the PNSP or as designated by the PNSP. In accordance with NENA i3 the RNSP NGCS ESRP/PRF will be configured to redirect transfers originating from a PSAP served by the RNSP using the RFC 3515 SIP REFER method together with a Replaces header as part of a transfer operation to the serving ESRP. The request will be forwarded to the PNSP ESRP for routing within the PNSP. The Regional ESRP and the Prime ESRP are connected through a BCF-to-BCF interface and known to each other through their Credentialing Authority (CA) issued certificates.

EXHIBIT 20: TECHNICAL REQUIREMENTS NARRATIVE RESPONSE
NGA 911, LLC

Additionally, NGA 911 proposed an inter-regional transfer architecture in the case where the Prime fails. NGA 911 will establish routing information that offers a backup path on the regional ESRP (and made available through the Policy Store) to contact the neighboring regional ESRP for transfer requests.

Diagram 23.0.2.1 PSAP not reachable due network failure but NGCS functioning. The issue is detected by NMS, the Policy Store is updated, the Regional PRF directs signaling to the PNSP which establishes the call. Call is anchored in Region but serviced by PNSP.

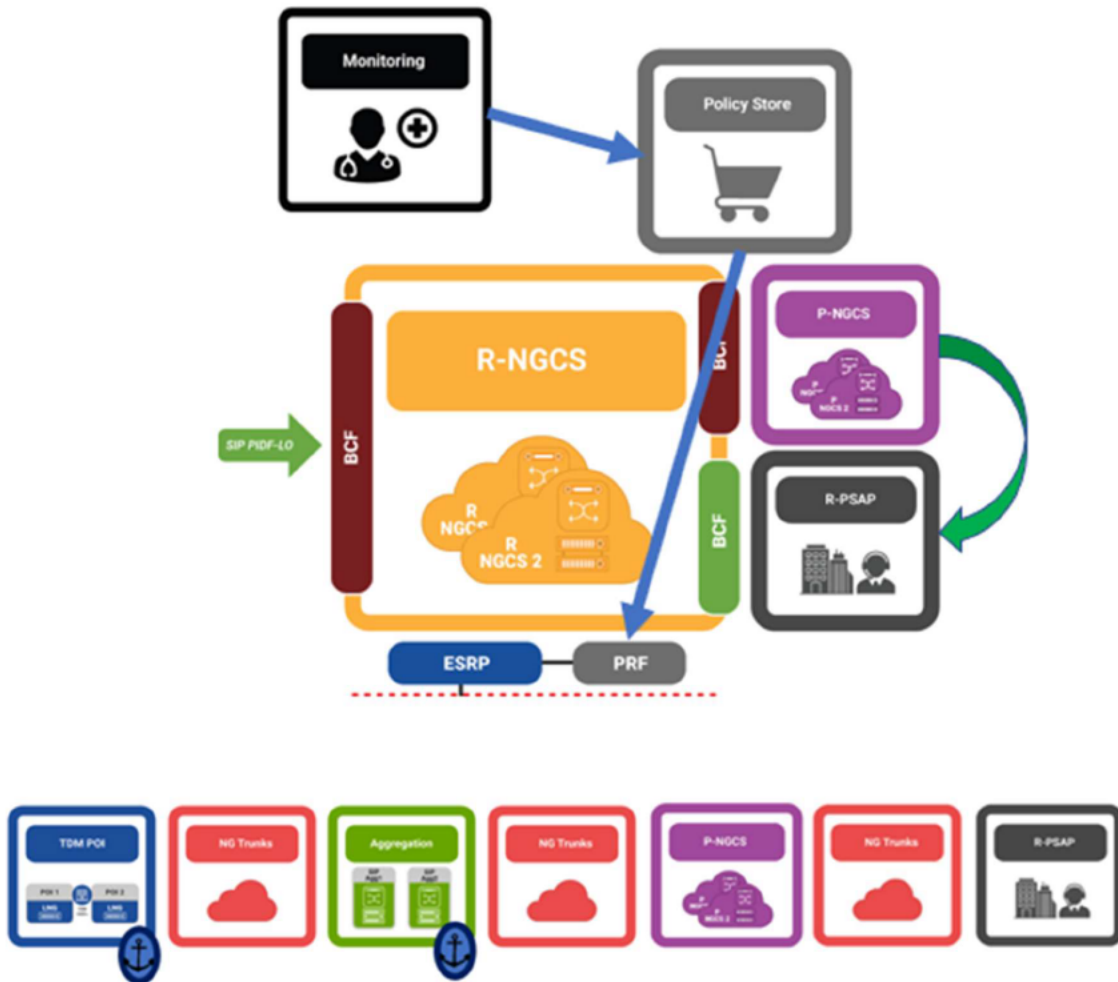

EXHIBIT 20: TECHNICAL REQUIREMENTS NARRATIVE RESPONSE NGA 911, LLC

Diagram 23.0.2.2 If the Regional Core is down, calls can be directed by the Regional Aggregation Service directly to PNSP with call Anchoring remaining at the Regional Aggregation Service.

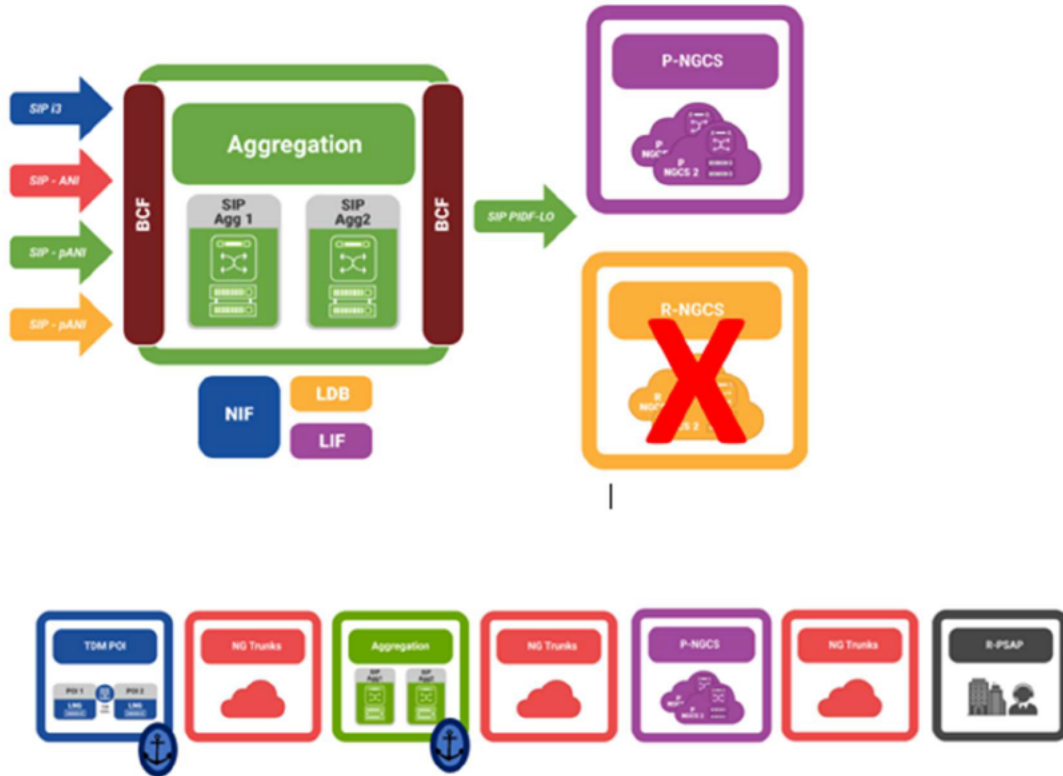

EXHIBIT 20: TECHNICAL REQUIREMENTS NARRATIVE RESPONSE NGA 911, LLC

Diagram 23.0.2.3 The Regional SIP Aggregation is down, but the POI is operational and the call has been converted to SIP by the LNG located at the POI. If the NG Trunks are capable of reaching the Prime Aggregation Point, then the call can be routed (by trunk naming convention or other means), through the PNSP with call being anchored to the Regional POI.



EXHIBIT 20: TECHNICAL REQUIREMENTS NARRATIVE RESPONSE NGA 911, LLC

Diagram 23.0.2.4 The PRF provides for out of Region routing.

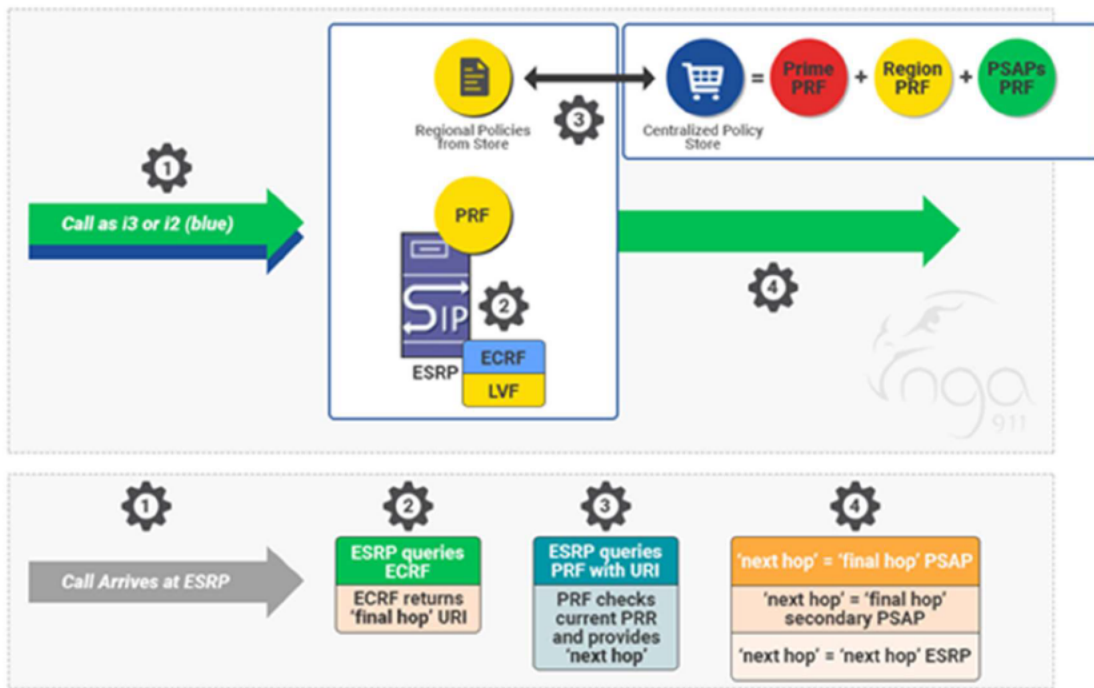

Copyright © 2019 All Rights Reserved NGA911

EXHIBIT 20: TECHNICAL REQUIREMENTS NARRATIVE RESPONSE NGA 911, LLC

Diagram 23.0.2.5 Transfer call to other Region (a) is received at PSAP 1 and anchored at POI or Aggregation depending on origin (legacy or i3). (b) call is transferred to PSAP 2 in another Region via PNSP, and (c) PSAP 1 leaves the call and PSAP 2 takes the call but session media anchor remains at Regional POI or Aggregation.

(a)

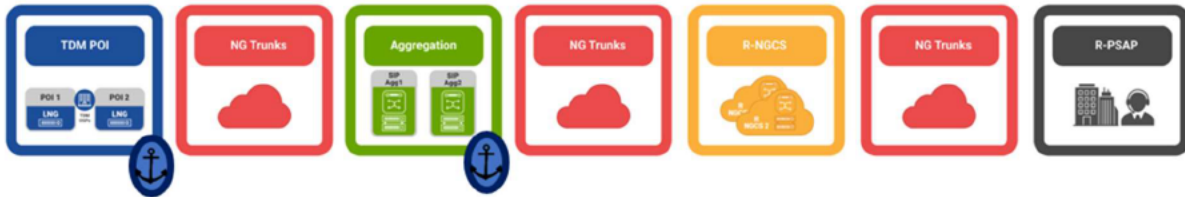

(b)



(c)

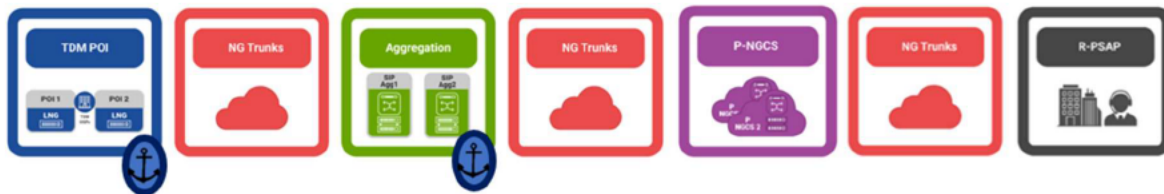

EXHIBIT 20: TECHNICAL REQUIREMENTS NARRATIVE RESPONSE

NGA 911, LLC

Exhibit 23: 23.0.3

Describe the program management, collaboration and communication needed for the RNSP to comply with the best practices and interfaces developed for POI, aggregation, Region to Prime interface and Region/Prime interface to PSAP by the PNSP in coordination with the CA 9-1-1 Branch that demonstrates a commitment to transparency.

RESPONSE:

Transparency is part of the NGA 911 culture. From our solution to our service, we understand that transparent communication breeds trust, which is essential to success. Our solution is a non-proprietary, NENA and IETF standards-based solution that supports interoperability. Our organization has a culture of open communication and information sharing with no trade secrets or industry secrets. When there is trouble reported or an outage, NGA 911 will comply with SLAs and provide immediate Root Cause analysis. Additionally, Cal OES or any other authorized stakeholder can login to the NGA 911 Administrative Portal and pull a trouble report which will include ticket number, date/time of trouble reported, reporting party information, summary of work completed, status of ticket or resolution. Furthermore, when there is a problem, NGA 911 operates in complete transparency and with real-time visibility in collaboration with all our partners to ensure timely handling and future mitigation of risk. NGA 911 will bring this same commitment to working with the PNSP Contractor Aggregation Service Provider, Cal OES, and any other stakeholder.

Program Management and Communication to Comply with Best Practices

Initial collaboration and communication will begin the day of contract execution. NGA 911 will coordinate a kick off meeting date with Cal OES and the PNSP to begin development of the Interface and Implementation Project Deployment Plan which will be completed within 60 days of contract award. NGA 911 will continue its communication through program management with its ongoing participation in daily/weekly meetings with Cal OES and the PNSP. Additionally, NGA 911 will provide all Project Plans and documentation required by Cal OES and the Prime.

NGA 911's Program Management aligns with our comprehensive Service Realization Quality Management System (QMS) - Diagram 23.0.3.1, NGA 911 will provide a login to the NGA 911 Administrative Portal that houses the Configuration management database that documents all of the software, systems, network protocols, port usage and relevant system related information in a mutually agreed upon format. This configuration database shall include a linkage to our change management process to ensure that any change request that is implemented will result in an update to the configuration management database. NGA 911 follows industry standards and best practices such as ISO 9001 Continuous Improvement Processes and ITIL. The CA 9-1-1 Branch accessible configuration management database provided by NGA 911 conforms to all of the requirements stated listed in 23.1.12.

Quality Management - NGA 911 considers the Quality of our products and services as our number 1 priority. Our approach is tracked and monitored with feedback loops to ensure success as per ISO-9001 Continuous Improvement Processes. There are a series of projects which we regularly review, that are linked and actively monitored by the NGA 911 Cal OES Team Lead who reports directly to Management. These include those programs and projects run by the NGA 911 Project, Trunk Services, Aggregation Services, Core Services, Region Functions and Services, System Monitoring and Outage Reporting Coordinators, the Training Lead, the Product Realization Manager, Interoperability Coordinator, and the Risk Manager.

Collaborating on Standards and Interfaces

NGA 911 has been in continuous collaboration with many of the industry 9-1-1 partners through our Three Step Program Trials to demonstrate SIP i3 call delivery to existing PSAPs. NGA 911 collaborates with PSAPs, their legacy network vendors (VPN and SBC setup), their CPE vendors, and our own teams, Infrastructure, Engineering - Network and Systems, Project Management, Sales Team, Management, and R&D to set up, test, and deliver calls from a device, through our NGCS, to a designated (by user device location) PSAP for call completion at the Call Handling Position. At this point we have completed over a dozen of these Trials involving PSAP's IT departments, [REDACTED] and many others on the Firewall, Addressing, Port, Session and Terminal Networking; and [REDACTED] on the CPE and SIP protocol side. Each interaction involves sharing and aligning configuration, networking, product, software, SIP standard,

EXHIBIT 20: TECHNICAL REQUIREMENTS NARRATIVE RESPONSE

NGA 911, LLC

HELD, PIDF-LO, and/or Legacy Interface (ESRK, TN, ALI, etc) data and settings. When we work with a specific CPE vendor for the first time, we test in their labs prior to setting up a VPN/SBC and terminating a session in the PSAP. NGA 911 recommends pilot testing in the Cal OES lab. NGA 911 and the system under test (SUT) make adjustments to parameters, file formats, and header values to accommodate and facilitate the test. Ideally, we end up in a situation where both parties are completely compliant with the understood specifications such as the i3 SIP Header Format and/or the other relevant RFCs. Currently, since most vendors are not 100% i3, NGA 911 works with the CPE vendor and PSAP to deliver ALI data via a standard SIP Header until a time that the vendor can terminate an i3 SIP Header. We have set up a test BCF/SBC interface (including Firewall and SIP Trunk settings) with third party IPX providers and wireless carriers for the testing of simulated emergency RTT calls.

NGA 911's agile approach has streamlined collaboration, information sharing, and configuring systems. We can test and assess, evaluate and adjust, define a solution or set of solutions to implement, and operate a reliable interface with many different and diverse partners at all layers of the network and systems. In the case of PNSP and RNSP disagreement, alignment and harmony between PNSP and RNSP are essential for success. **If there is a need for arbitration, NGA 911 recommends that the following protocol** be followed between the PNSP and RNSP: (i) within 24 hours PNSP and RNSP will conduct a review of the standards set forth by IETF, 3GPP, NENA, or a similar authoritative standards body to determine if the issue has already been thoroughly handled; (ii) within 36 hours both PNSP and RNSP will provide a detailed written summary for their respective positions; (iii) within 48 hours both PNSP and RNSP will submit a written summary and conduct verbal discussions to Cal OES; (iv) Cal OES will render a final judgement.

Agreeing on Interfaces. As demonstrated by the experience and statements above NGA 911 is prepared to work with Cal OES and the Prime in the development and implementation of the specific standards, protocols, and configurations for any interfaces specified. We are confident that all parties will make use of best practices, experience, and generally accepted standards and specifications when agreeing on the implementation of a specific interface. NGA 911 concedes and agrees that the final determination rests with Cal OES and its Prime's judgment to which NGA 911 will comply.

Interface Specific Considerations

TDM POI – We will deploy the POI by working with each of the OSPs and particularly the major ILECs. We have already developed and implemented a formal approach to engaging the OSPs for West Virginia, Louisiana, and Nevada. NGA 911 will replicate this process for California. Our approach is to encourage a transition to i3, but we are prepared under the guidance of Cal OES, and as applicable to the Prime, to deploy POI's in the LATAs (for ILECs) and configure the LNGs through a rigorous Product Realization process to reliably provide PIF for delivery of a SIP call (over an NG Trunk if necessary) to the SIP Aggregation Service where NIF and LIF will be carried out as required to generate as best as possible an i3 SIP INVITE (in a format defined, specified, tested and accepted by Cal OES and the Prime). Phase 1 and 2 E911 wireless OSPs will be asked to deliver their calls to the POIs located at the Aggregation Services Data Center but will have the option of meeting at any qualified POI in the Region.

SIP Aggregation – aggregation entails a BCF that needs to interoperate with a number of parties. NGA 911 can process calls directly from the OSP or their 3rd party location service providers in either i2 or i3 format, or indirectly from the TDM/Legacy POI's having been converted to SIP but likely to be in need of Network and Location Interworking (NIF and LIF). NGA 911 will work very closely with Cal OES, and the Prime on developing and implementing the required standards and interfaces entailed related to the NIF, LIF, LDB, and Positioning Center interactions required for location-based routing. The egress of Aggregation is either to the Region or Prime BCF where the Aggregation BCF acts as the call and media anchor for the OSP call session. NGA 911 will collaborate with Cal OES and the Prime in defining all of the BCF interfaces required for the secure, reliable and high-fidelity handling of the call (see section 23.0.14 BCF Firewall for details on all the interfaces).

Region to Prime – This is similar but not identical to the Aggregation Service to the Prime. The interfaces here are between the Regional BCF and Prime BCF for the ESRP. Other interfaces to support the NGCS include - the Dashboards and NMS (see 23.0.8 and .9) the SI, the ECRF, LVF, LDB (see 23.0.6 and .7) and the Centralized PRRs (see 23.0.13). NGA 911 is ready and able to cooperate in implementing each one of these.

Region/Prime interfaces at the PSAP. Currently Cal OES is looking at separate networks, each with its own SD-WAN where each party manages their own network. With CAPSNET being part of the Prime Network. A dual SIM Cradlepoint LTE modem could each have a link dedicated – one to the Prime and one to the Region. Even though these networks are operated independently, NGA 911 is obligated to provide Cal OES and the Prime network and performance monitoring APIs on our SD-WAN network.

EXHIBIT 20: TECHNICAL REQUIREMENTS NARRATIVE RESPONSE NGA 911, LLC

Diagram 23.0.3.1 NGA 911 Quality Management Collaborative Continuous Improvement Process

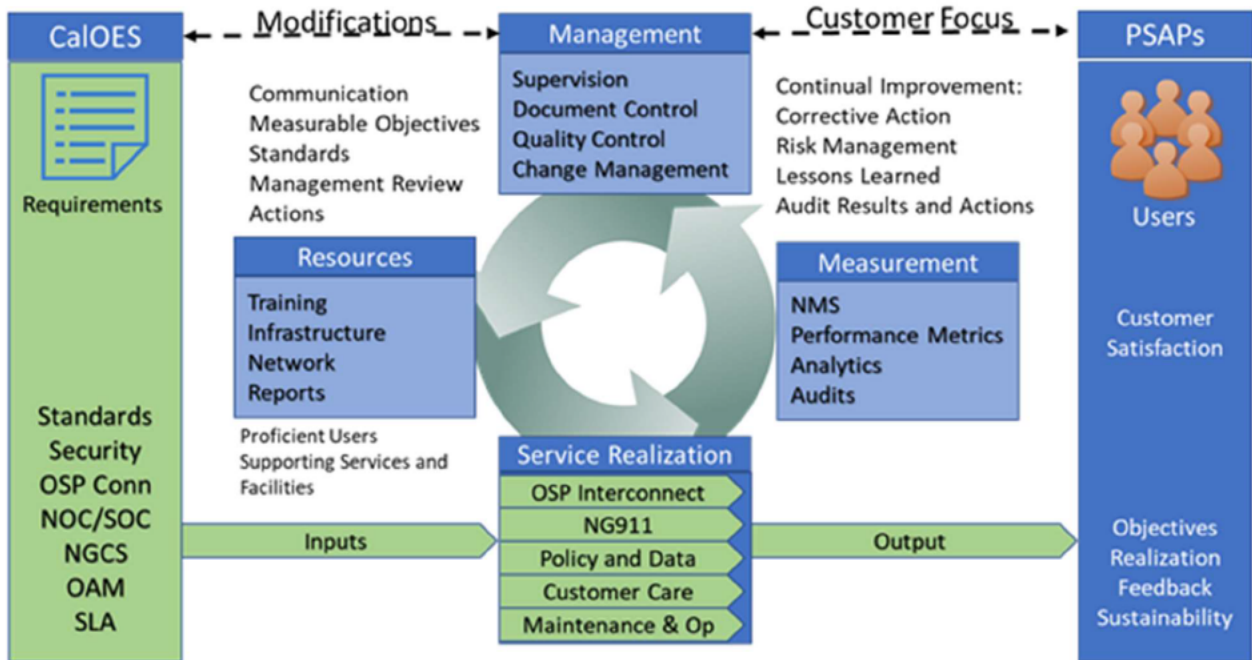

EXHIBIT 20: TECHNICAL REQUIREMENTS NARRATIVE RESPONSE
NGA 911, LLC

Exhibit 23: 23.0.4

9-1-1's current technology routes wireless and Voice over IP (VoIP) calls by a predetermined pseudo ANI (pANI) assigned to a cell tower/cell sector. This often results in 9-1-1 calls initial delivery to the wrong PSAP. During 2017 in California, 3,758,748 of the 28,129,927, approximately 13% of the 9-1-1 calls received were transferred from one PSAP to another. This transfer can take several minutes and result in the loss of life or property. Additionally, 9-1-1 transfers consume a lot of time and resources. With the proliferation of wireless technology networks and the increasing dependence on wireless devices it is critical to be able to route accurately by wireless device location.

NGA 911 is a leader in the receiving, processing, analyzing and delivering of location data. All of the capabilities mentioned herein are demonstrable today. We can receive location in every possible format. We process the location information by formatting and parsing it for direct delivery to the PSAP's CPE. This exceptional flexibility allows us to handle the current, transitional, and next generation of location availability and delivery.

NGA 911 has implemented a fully functional Emergency Call Routing Function (ECRF), Location Validation Function (LVF), and a supporting Location Information Server (LIS) from which we already conduct location-based routing based on shape files representing routing boundaries.

Our abilities to exceed the location requirements for Cal OES are demonstrated by our current location projects each of which has unique capabilities or operational scenarios:

1. A Location Database (LDB) with Automatic Location Identification/Master Street Addressing Guide (ALI/MSAG) data for location handling that incorporates Landline, VoIP, and Wireless locations from a LIS we developed.
2. Location clearing house [REDACTED] for use in projects in the United States and overseas.
3. The [REDACTED] with a Location Verification Trial that seeks to determine the accuracy and timeliness of location data provided through AML and ELS.
4. A number of major Wireless OSPs that wish to deliver location in a number of different formats including through an ingress Border Control Function (i-BCF), Open Mobile Alliance Converged IP Messaging (OMA CPM), and RFC 4119 (Geopriv Location Object).
5. Two providers of Geographic Information System (GIS), Spatial Interface (SI), LVF, and ECRF services for interworking with our existing ECRF.
6. A CPE call handling system upgrade to convert from a NENA ALI xml format to Presence Information Data Format – Location Object (PIDF-LO).

Originating Service Provider Location Data

NGA 911 is leading the way in innovative OSP location routing. We are currently working with a Tier I carrier to receive Location by Object over the major national roaming Internetwork Packet Exchange (IPX) aggregator. This robust approach is based on the international wireless roaming hub infrastructure that already handles millions of transactions between Mobile Network Operators (MNOs) an hour and ensures our service availability is pervasive, tested, and bulletproof with all MNOs.

NGA 911 has the capability to accept location data from OSPs in any number of formats as detailed above. We recommend that Cal OES and Prime as the standard setting authorities of the ESInet and Next Generation 9-1-1 (NG9-1-1) solution for the state, define the standard for location delivery based on the

EXHIBIT 20: TECHNICAL REQUIREMENTS NARRATIVE RESPONSE

NGA 911, LLC

NENA i3 specification: Location in NG9-1-1 is represented by content in a PIDF-LO document (RFC 4119, updated by RFC 5139 and RFC 5491) with field use for the United States as documented in the NENA Civic Location Data eXchange Format (CLDXF). The NGA 911 i3 SIP Header provides both the civic and geodetic profiles in the PIDF-LO.

Device Operating System Format

Device location information can be delivered to NGA 911's NGCS from any device as we've demonstrated with our partner CarePoint with Samsung. We integrated with Samsung's wearable technology to receive and process all available wearable sensor information including gps and heart rate. Furthermore, NGA 911 has a working relationship with RapidSOS that provides the delivery of location data based on AML and ELS. Additionally, there are other methods for retrieving location and location enhancing data from the device sensors including, GPS, WiFi SSID's, accelerometer, and other sensors that NGA 911's NGCS is capable of receiving, processing, and delivering to PSAPs. In the near future additional z-axis technologies for 3D elevation location will be available many of which will be device driven. Cal OES can be assured that NGA 911 will be at the forefront of adopting and implementing these capabilities for use in our NGCS.

Location Clearing House (additional ECRF's)

NGA 911 is integrated with RapidSOS, and demonstrated that Clearing House location information can be used to route calls. Further deepening our solution, NGA 911 has its own ECRF for call routing which enables near real time boundary updates. NGA 911's NGCS is capable of integrating location data from any number of external sources - whether ALI, MSAG, LDB, LIS or the State GIS. The NENA i3 standard takes whatever sources are available and processes them through a SI for use by the ECRF/LVF. ECRF's may come from a number of sources including OSPs and other ESInets. ECRF's can be made available to entities outside the region as long as they are credentialed with the BCF through a qualified CA. The need for an external facing ECRF is dependent on how the State will route calls at the ingress. If an external ECRF is required, NGA 911 proposes that there be one inside the ESInet to provide more granular routing (specific PSAP, agency, etc.) after ingress. We will work with any entity that needs authorized access and provide credentialing accordingly.

EXHIBIT 20: TECHNICAL REQUIREMENTS NARRATIVE RESPONSE
NGA 911, LLC

Exhibit 23: 23.0.5

Describe the methodology that will be employed after contract award to ensure NG9-1-1 services provided are consistent with tariff filings.

Response:

All language stated in the tariff are contractual commitments to the State of California by NGA 911. These are enforced through transparently monitored, real-time visibility, independently auditable Service Level Agreements (SLAs) and specific Tariff related commitments.

NGA 911 will begin Tariff compliance by assigning a Compliance Administrator to the NG9-1-1 project implementation and ongoing maintenance.

Tariff compliance begins with the CPUC. NGA 911 will maintain compliance with the CPUC as a CPCN holder including quarterly and annual filings, paying fees, tariffs, and responding to all requests for information. NGA 911 will further ensure that any subcontractor providing aggregation service or performing more than 20% of the work will also maintain a CPCN with the CPUC.

NGA 911 will only begin work after receiving an approved TDe-289 from Cal OES. To begin the approval process, NGA 911 will complete the following steps:

1. NGA 911 will submit all required supporting documentation to the CA 9-1-1 Branch
 - a. Copy of completed TDe-289
 - b. Tariff pricing for each line item and reference to NG9-1-1 Tariff filing
 - c. Project pricing broken out by service by NRC and MRC
2. Upon receipt of an approved CA 9-1-1 Branch TDe-289, NGA 911 will proceed with ordering services and initiate the project.
3. NGA 911 Cal OES Team Lead assigns an internal Project Manager who in alignment with our QMS uses a hybrid approach that includes standard Project Management and an Agile methodology after project award. This methodology emphasizes sharing and standardization of process across NGA 911, allowing for monitoring of SLAs and Tariff requirements from the Executive Management out to the Operations and Maintenance personnel. By integrating the processes across the organization, it gives Operation, Deployment, and Maintenance teams better insight into the various requirements and ensures the right resources are assigned to monitoring, maintaining, and reporting. It is essential that NGA 911 provide services that are consistent with the Tariff so that the needs of the State of California are met according to the expectations outlined in the Tariff. Furthermore, the Tariff establishes and fixes the cost to the State of California for the services defined, so there should be no unexpected or hidden fees when ordering and delivering service according to the Tariff.

NGA 911 will also use the Information Technology Infrastructure Library (ITIL) Process Map, and the ITIL Responsibility Assignment Matrix (RACI) to document and track the entire transition and deployment process to ensure the NG9-1-1 services provided to Cal OES, the PNSP, and its PSAPS are consistent with our Tariff filing.

This methodology is consistent with Tariff filings and provides a perfect blend between the Integrated and Agile methods by monitoring obligation performance to ensure compliance with all specified terms. Performance monitoring to include:

- a. Input of relevant compliance data to control systems
- b. Identification of compliance variations and exposures including frequencies
- c. Management reporting

EXHIBIT 20: TECHNICAL REQUIREMENTS NARRATIVE RESPONSE
NGA 911, LLC

- d. Internal Audits
 - e. Change initiative tracking and approval
4. NGA will meet with Cal OES to develop Project Milestones for services ordered. NGA 911 will report against the established Project Milestones using the Project Milestone Report at a frequency defined by the CA 9-1-1 Branch.
 5. NGA 911 consistent with the PDP and Tariff requirements, will begin execution on the design, deployment, testing, acceptance, and operation of the Regional ESInet to include Cal OES's ordering through the tariff of Aggregation Services, NG Trunks, Regional Core Services, and Regional Functions and Services (such as PSAP Integration).
 6. Upon completion of burn-in period, final acceptance, and commencement of operations of each Tariff item, NGA 911 monitors each function and service to ensure compliance with Tariff and associated SLA's including, but not limited to: POI ingress volumes; Aggregation interfaces: BCF, NIF, LIF, LDB, Positioning Center; NG Trunks: bandwidth, jitter, latency, traffic type; Core Services: BCF, ESRP/PRF. ECRF/LVF, uptime, request volumes, and DR's, etc; Regional Functions and Services: end-to-end media performance monitoring for jitter, latency and MOS, and functional element infrastructure loading. All elements are available for view on the NGA 911 Dashboard and available for reporting through the MIS.
 7. NGA 911 will maintain compliance with SLAs and provide monthly reports on any network outages and provide Root Cause Analysis to Cal OES for major outages or upon request.
 8. NGA 911 will invoice CA 9-1-1 Branch only for the milestone services after system testing, and acceptance or other agreed upon Milestone with NGA 911 and CA 9-1-1 Branch. All NRC and MRC will be submitted on separate invoices. NGA 911 will use the Invoice template as provided by CA 9-1-1 Branch for all invoicing.

The advantages of this program management methodology approach include:

1. **Transparency:** Integrating processes across the organization provides transparency within the organization. The approach focuses on team members documenting and meeting regularly, which helps keep everyone in the loop.
2. **Accountability:** The integrated nature of this approach makes the entire project team responsible for the project. Since no team member can operate in a silo, NGA 911's approach improves accountability.

Benefits to Project Managers

Project Managers (and others) find planning and tracking are easier and more concrete, compared to waterfall processes. The focus on task-level tracking, the use of Burndown Charts to display daily progress, and the Daily Stand-up meetings, all together give the Project Manager tremendous awareness about the state of the project at all times. This awareness is crucial in monitoring the project, and to catching and addressing issues quickly.

Benefits to Cal OES and C-Level Executives

High visibility into the state of a project, on a daily basis. External stakeholders, such as C-Level executives and personnel in the Cal OES, can use this visibility to plan more effectively.

EXHIBIT 20: TECHNICAL REQUIREMENTS NARRATIVE RESPONSE
NGA 911, LLC

Exhibit 23: 23.0.5.1

Of the four regions, what is your preferred region and why your company would have an advantage in that region? Why is this region assignment in the best interest of The State? The State makes no guarantee preferences will be accommodated and region assignment is determined solely by the State to achieve the best NG 9-1-1 solution.

Response:

Preference 1: Los Angeles Region

Why NGA 911 has an advantage:

- NGA 911 has first-hand knowledge of this unique region from the pre-existing ESInet, the Pasadena Ring Project, the geo-diverse host remote 9-1-1 CPE deployment for LASD, a soon to be geo-diverse host remote 9-1-1 CPE deployment in Long Beach PD/FD and a combination of small medium and large (LAPD/FD) PSAPs.
- Due to the fact the Los Angeles Region takes the most 9-1-1 calls of any region, NGA 911 is uniquely qualified with our cloud-based approach to computing and infrastructure to manage this region with our scalability and resilience that is proven to handle high call volumes.

Why NGA 911 for Los Angeles Region is in the best interest of the State:

- We provide essential elastic load balancing and auto scaling to accommodate the PSAPs substantial increase in call volume during a wildfire, earthquake, flooding, and other larger scale and catastrophic events.
- NGA 911 understands the Los Angeles region is the most complicated region and the NGA 911 Project Manager and team has subject matter expertise, experience with California, and has proven trusted relationships with the County Coordinator, PSAPs, and Vendors. These relationships were built through years of leadership in California, partnership with Cal OES on previous projects, and successful collaboration and execution of statewide implementations of Cal OES driven initiatives, i.e. Wireless Routing, VoIP Routing, and Text to 9-1-1.
- The state gets NGA 911 that has a close working relationship with the Los Angeles County Coordinator.
- The state gets NGA 911 that has attended and presented to the Los Angeles County PSAP Managers.
- The state gets NGA 911 that will work with AT&T on the ESInet to ESInet connectivity for the Pasadena Ring Project.
- That state gets NGA 911 that will work with Long Beach Beach PD/FD for the optimal deployment of NG9-1-1 trunks to the Long Beach geo-diverse system which is currently housed in one facility and will be moving to a geo-diverse deployment in the near future.
- The state gets NGA 911's unique understanding of the CHP PSAPS in the Los Angeles Region.
- The state gets NGA 911 which has tested its NGCS with all CPE manufacturers in the Los Angeles Region.
- The state gets NGA 911 which has quotes and mapped out the NG9-1-1 trunks for all PSAPs in the Los Angeles region.
- The state gets the world's top data centers with AWS and Google that provides an additional layer of infrastructure.
- The state gets the world's foremost experts in cybersecurity.
- The state gets expand the flexibility and solution options because our solution does not involve old mega switches or infrastructure.
- The state reduces project risk with NGA 911's obsessive investment in NGCS (the ESInet brain) R&D and cloud engineering expertise.
- The state facilitates NENA end state in California with our IMS core gateways at the SIP Aggregation Points.
- The state gets transparent authentication that each Regional deployment is autonomous and architected according to the standards set forth by the PNSP.
- The state will have no surprises with our NGCS since development is completely independent, has no licensing restrictions, is transparent with non-proprietary hardware and it does not depend on any other development team.

Preference 2: Southern Region

Why NGA 911 has an advantage:

- NGA 911 has a unique understanding of the major metropolitan coastal areas to the smaller remote desert areas. These areas have a geo-diverse host remote 9-1-1 CPE installation for CONFIRE and SBCSO that is in the process of being upgraded. The 9-1-1 CPE in the Southern Region is provided and supported by AT&T, Frontier, and Carousel.

EXHIBIT 20: TECHNICAL REQUIREMENTS NARRATIVE RESPONSE

NGA 911, LLC

Why NGA 911 for Southern Region is in the best interest of the State

- The state gets NGA which provides essential elastic load balancing and auto scaling to accommodate the PSAPs substantial increase in call volume during an earthquake, flooding, typhon, Hwy 1 sinkholes, and other larger scale situations.
- The state gets NGA 911 staff which has a strong working relationship with Riverside, San Bernardino and San Diego County Coordinators.
- The state gets NGA 911 staff which have a strong working relationship with CONFIRE and SBCSO and will work closely with them to ensure continuity during the upgrade.
- The state gets NGA 911 staff which has a strong working relationship with the San Diego Sheriff's Department.
- The state gets NGA 911 staff which has a strong working relationship with Riverside Fire and Sheriff's Office.
- The state gets NGA 911 staff which has a unique understanding of the CHP PSAPs in the Southern Region.
- The state gets NGA 911 has tested its NGCS with all 9-1-1 CPE manufacturers in the Southern Region.
- The state gets NGA 911 which has quotes and mapped the NG9-1-1 Trunks for the Southern Region.
- The state gets the world's top data centers with AWS and Google that provides an additional layer of infrastructure.
- The state gets the world's foremost experts in cybersecurity.
- The state gets expand the flexibility and solution options because our solution does not involve old mega switches or infrastructure.
- The state reduces project risk with NGA 911's obsessive investment in NGCS (the ESInet brain) R&D and cloud engineering expertise.
- The state facilitates NENA end state in California with our IMS core gateways at the SIP Aggregation Points.
- The state gets transparent authentication that each Regional deployment is autonomous and architected according to the standards set forth by the PNSP.
- The state will have no surprises with our NGCS since development is completely independent, has no licensing restrictions, is transparent with non-proprietary hardware and it does not depend on any other development team.

Preference 3: Northern Regions

Why NGA 911 has an advantage:

- NGA 911 understands the Northern region and the NGA 911 Project Manager and team has subject matter expertise, experience with California, and has proven trusted relationships with the County Coordinator, PSAPs, and Vendors. These relationships were built through years of leadership in California, partnership with Cal OES on previous projects, and successful collaboration and execution of statewide implementations of Cal OES driven initiatives, i.e. Wireless Routing, VoIP Routing, and Text to 9-1-1.

Why NGA 911 for Northern Region is in the best interest of the State:

It is in the best interest of the state to select a vendor with elastic load balancing and auto scaling to accommodate the PSAPs substantial increase in call volume during an earthquake, flooding from the dams, wildfires, and other larger scale situations.

- The state gets NGA 911 which has quotes and mapped out the NG9-1-1 Trunks for both the Northern Region.
- The state gets NGA 911 which was awarded Northern Nevada and will be working with the Nevada selective router during this project as well.
- The state gets the world's top data centers with AWS and Google that provides an additional layer of infrastructure.
- The state gets the world's foremost experts in cybersecurity.
- The state gets expand the flexibility and solution options because our solution does not involve old mega switches or infrastructure.
- The state reduces project risk with NGA 911's obsessive investment in NGCS (the ESInet brain) R&D and cloud engineering expertise.
- The state facilitates NENA end state in California with our IMS core gateways at the SIP Aggregation Points.
- The state gets transparent authentication that each Regional deployment is autonomous and architected according to the standards set forth by the PNSP.
- The state will have no surprises with our NGCS since development is completely independent, has no licensing restrictions, is transparent with non-proprietary hardware and it does not depend on any other development team.

Project Visualization

EXHIBIT 20: TECHNICAL REQUIREMENTS NARRATIVE RESPONSE

NGA 911, LLC

For all Regions, NGA 911 has a program and project management advantages in all regions utilizing our mapping and project prioritization tools. See Diagrams 23.0.5.1.1-4 where we can visualize and analyze together with Cal OES and the Prime on how to best prioritize and cutover sites in terms of Region, Serving SR, inter-region issues, and PSAP capabilities (CPE, size, and readiness).

Multiple Region Award

In the case where Cal OES desires to award multiple Regions to a single vendor, NGA 911 is ideally situated to serve the Los Angeles and Southern Regions. Our flexible and scalable cloud-based approach is best able to accommodate the call flows between Regions especially due to the number of PSAPs that border Regions and number of selective routers that currently serve traffic across the Regions which will dictate the need to cutover both Regions at the same time.

Diagram 23.0.5.1.1 Mapping out Regions, SR's, PSAPs, and inter regional issues.

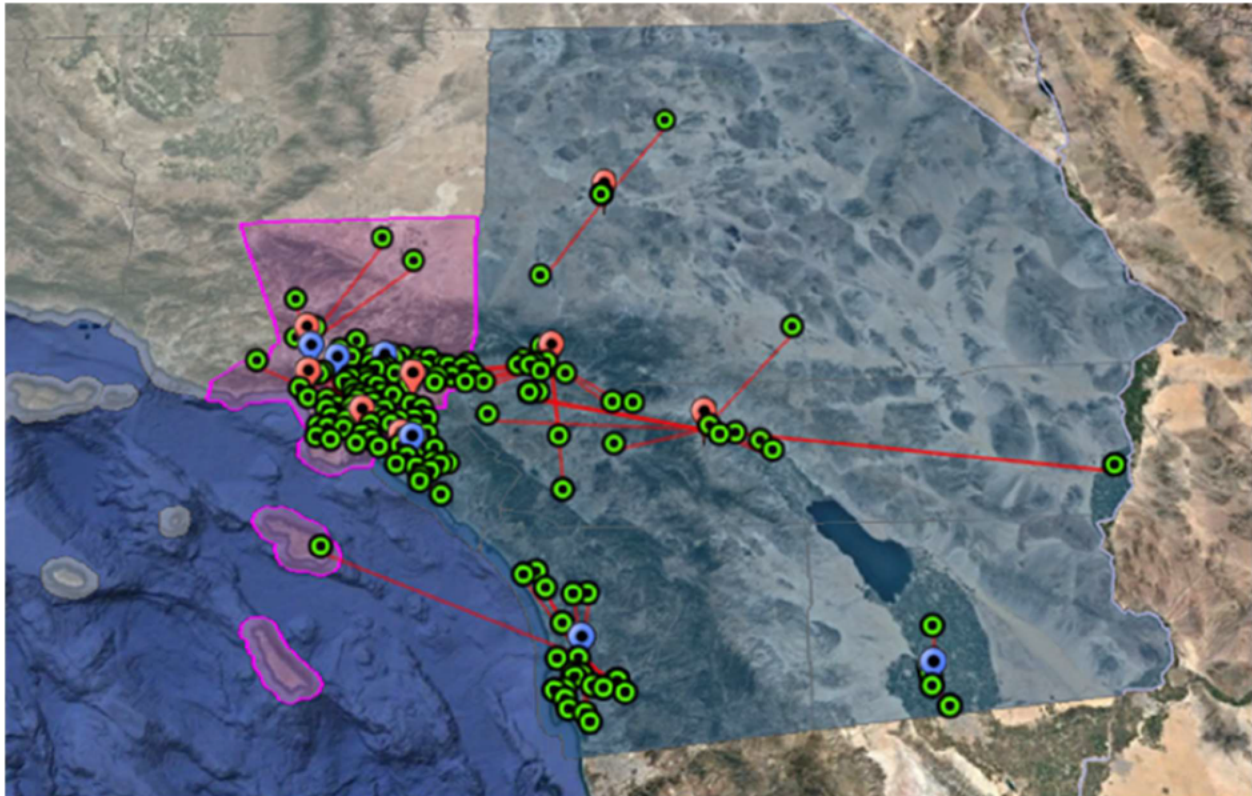

EXHIBIT 20: TECHNICAL REQUIREMENTS NARRATIVE RESPONSE NGA 911, LLC

Diagram 23.0.5.1.2 Drilling Down to a specific SR and the associated PSAPs for Project Planning and Implementation.

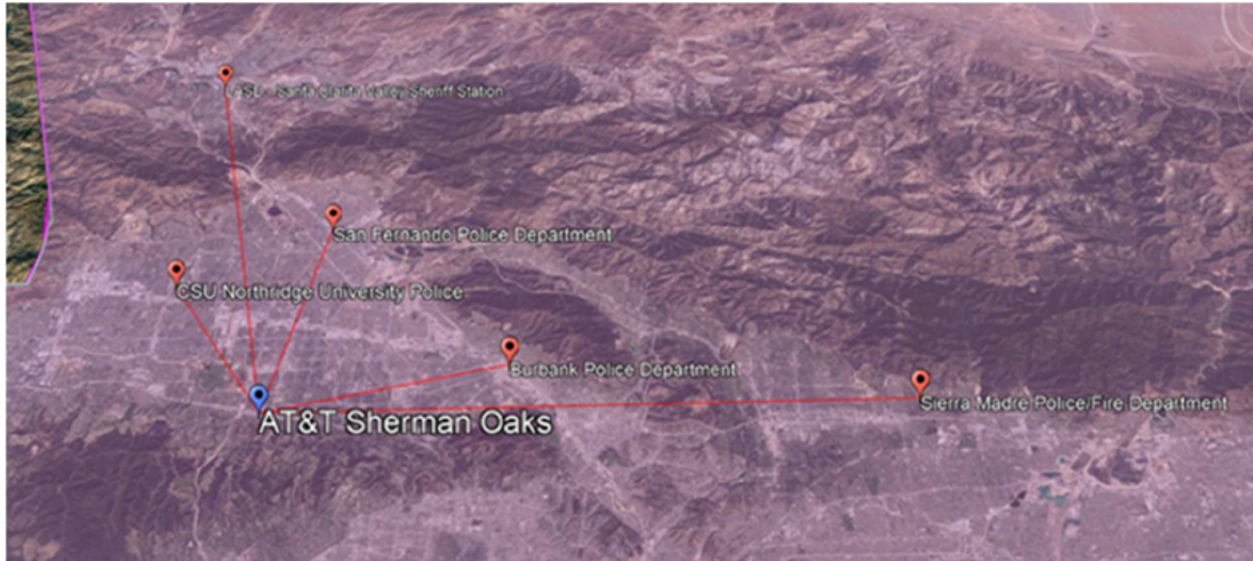

Diagram 23.0.5.1.3 Mapping out cross Regional overlaps for coordinating Project Planning and PSAP cutover.

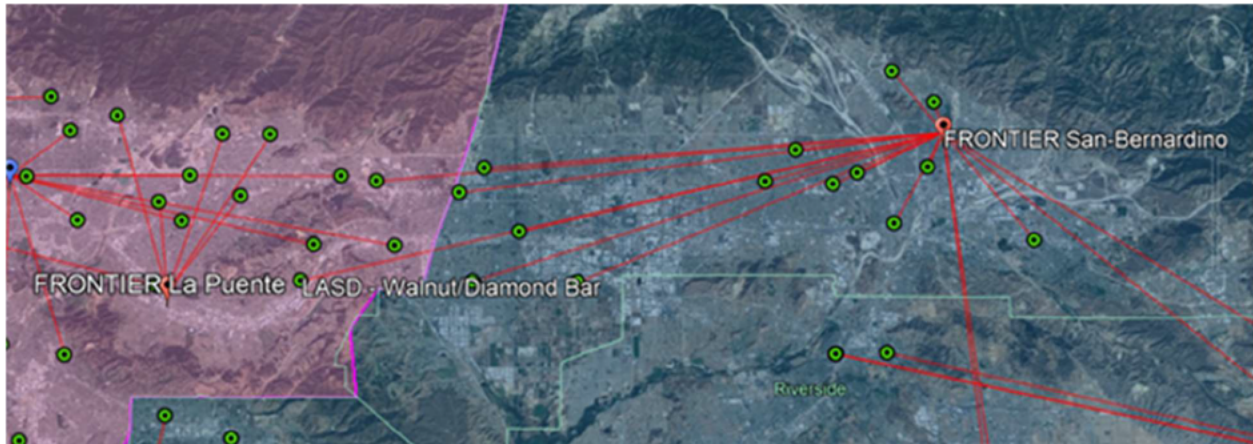

EXHIBIT 20: TECHNICAL REQUIREMENTS NARRATIVE RESPONSE
NGA 911, LLC

Diagram 23.0.5.1.4 Ability to highlight and prioritize sites based on status (color, size, shape, opaqueness, etc).

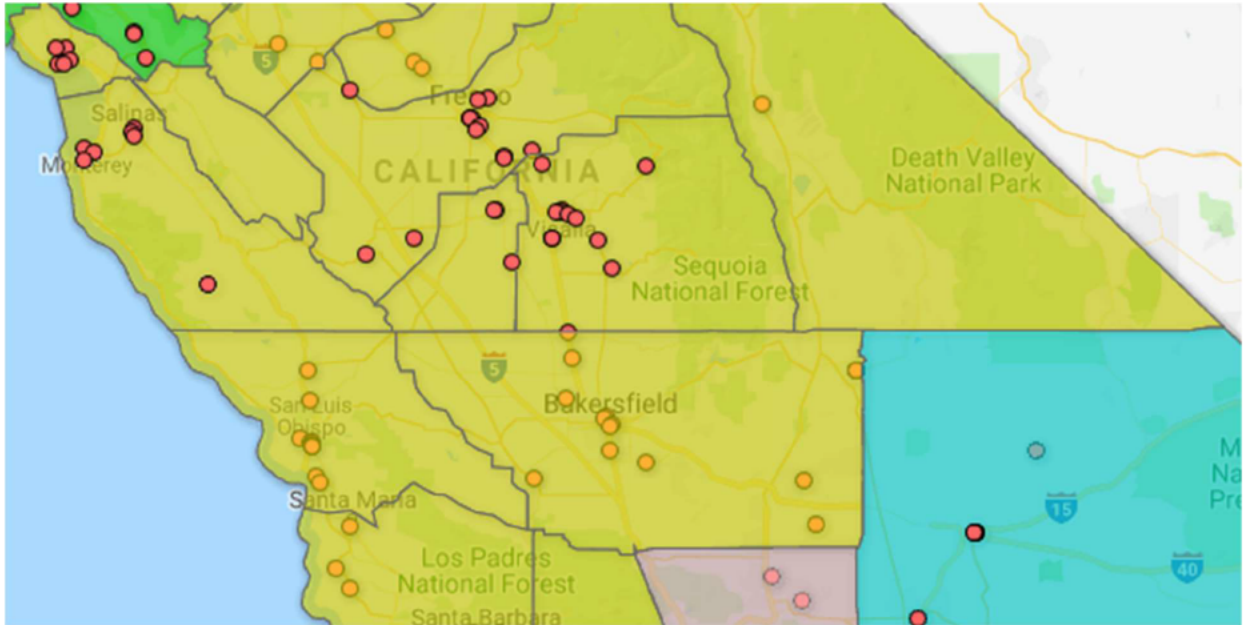

EXHIBIT 20: TECHNICAL REQUIREMENTS NARRATIVE RESPONSE

NGA 911, LLC

Exhibit 23: 23.0.6

Describe how the RNSP shall utilize the statewide GIS database that is maintained and updated by the NG 9-1-1 Prime vendor for routing all 9-1-1 traffic.

RESPONSE:

NGA 911 will utilize the statewide GIS database maintained and updated by the NG9-1-1 Prime vendor for routing all 9-1-1 traffic. Consistent call routing in California is achievable with a single authoritative Geographic Information System (GIS) database. Cal OES and the Prime are responsible for the assimilation, maintenance, and publishing of the statewide GIS database. NGA 911 will provide a Spatial Interface (SI) to update the NGA 911 Regional ECRF and LVFs per a standardized methodology and approach to input and validate from the GIS database. Furthermore, NGA 911 LDB and LIS will also be based on data collected, validated, and supplied by the OSPs directly to the Prime. In accordance with the SOW and Regional Exhibit Requirements (23), NGA 911 adheres to the following:

Regional Validation of LVF with OSPs (23.1.15): NGA 911 will work with OSPs (large ILECs) to validate the LVF maintained by PNSP so they can verify that civic addresses will return PSAP or emergency responder URIs. **ECRF Update (23.5.1):** NGA 911 will utilize the statewide GIS database maintained and updated by the NG9-1-1 Prime vendor to update PNSP ECRF for routing all 9-1-1 traffic.

GIS Standards (23.5.2): NGA 911 complies with GIS standards to include, but not limited to, NENA NG9-1-1 GIS Data Model, NENA 02-010, and NENA 02-014.

Updates from Prime (23.5.3): NGA 911 is capable of receiving updates to the GIS database from the PNSP, without disruption of ECRF LoST service. Updates shall be at least daily and shall be capable of receiving data updates 24x7x365 and provide confirmation receipt of data within 4 hours.

Maintenance Function (25.5.4) NGA 911 provides and proposes a process to integrate our maintenance function to upload the data from the statewide GIS dataset to update the ECRF and LVF to ensure proper routing of calls.

GIS Synchronization (23.5.5): NGA 911 will interface with the statewide 9-1-1 GIS synchronization and 9-1-1 database normalization processes.

DBMS (23.5.6): NGA 911 will utilize the Prime database management services (DBMS) needed for NG9-1-1 traffic delivery. Specifically, by updating the NGA 911 LDB based on the statewide DBMS.

The key success factor to working with the statewide GIS, Prime and Cal OES is the alignment of the NGA 911 SI with the GIS database formats, processes, flows, validation and discrepancy reporting (DR) methods (for DR see 23.0.7).

GIS SI validation of ECRF and LVF: The provision of GIS updates will occur through the SI which performs GIS validations, including validations to ensure routing integrity. The Quality Assurance and Quality Control (QA/QC) processes provided during the validation steps in the SI will prevent any unwanted gaps or overlaps from being provisioned in the ECRF. A change control system will be available to monitor and manage data discrepancies and to track data change requirements. Validated GIS updates are normalized and applied to the ECRF production instances in a manner that preserves availability and coordinates with other ESInet scheduled updates and activities.

Initial SI Integration: NGA 911 intends to **proactively** employ an Agile approach using a collaborative 'discover, define, design' approach working with Prime, Cal OES, to help ensure a smooth integration of our SI with the GIS DB rather than the standard way to do this which often is to be **reactively or passively** auditing the DB at delivery receipt later pointing out the flaws. Led by our Professional Certified GIS Analysts (GIS-P) with deep experience in federal and state address, point features, and boundaries, NGA 911 will assess the following to establish the business rules and configuration.

Operation and Maintenance of SI: After the initial setup and verification of the SI and the interfaces and process flows between the Region and the Prime GIS database; NGA 911 provides the following tools, processes, and methodologies for operating and maintaining the SI:

Step 1: Data Acquisition: We have built in a collaborative approach to discover, define, and design to a model where the **Prime will provide** all changes from statewide GIS. Changes will only be received via the Statewide GIS from the Prime, then the scheduled or notification API Call via SI will be the prime 3rd Party SI based on the SI Patch results based on agreed NENA compliant version management filters to determine the updates, inserts, and deletes to request. Configured sources will have drop folders automatically created by pre-configured feed parameters. To support proper file loading, compliance will support NENA-STA-005.1.1-2017 Provisioning and Maintenance of GIS data to ECRFs and LVFs, NENA-STA-010.2 NENA Detailed Functional and Interface Standards for the NENA i3 Solution, and NENA STA-015.10-2018 (Originally 02-010) Data Formats for E9 1 1 Data Exchange & GIS Mapping.

Step 2: Data Ingestion (Diagram 23.0.6.1): Once the file or service request is received, the received records will queue to support data ingestion into the Region ECRF, LVF, and LDB. To support near real-time queuing of record processing at over 1,000 records/minute, step 1 loaded files will trigger scripts to then decompose such files into individual GeoJSON records (files) by every Feature ID. This is a 'technical background step' the highest scalability and most robust data processing environment. This ends up populating the Step 3 Queue with each record, ready for processing in accordance with NENA 02-014 v1 GIS Data Collections and Maintenance Standards and REQ 002 NG9-1-1 Data Management

EXHIBIT 20: TECHNICAL REQUIREMENTS NARRATIVE RESPONSE

NGA 911, LLC

Requirements guidance. The system will accommodate ad-hoc changes, expedited changes, and a standard planned update process to ensure the most recent and vital information is available to assist callers and first responders. Updates occur on at least a daily basis, unless the update has an effective “on date.” The ECRF data administration tool uses role-based workflow with the capacity to support staging updates, and coordinates, at a minimum, receiving data updates 24/7/365 and providing a confirmation of receipt of data within 24 hours.

Step 3: Data Validation & Augmentation (Diagram 23.0.6.2): Each record will process by the associated feature class modular QC scripts written per NENA Standards/requirements based on Transition Business Rules Design to accommodate the third-party GIS data model, rules, attributes, etc. This will allow us to take the other parties standards and our standards to make it work with the statewide GIS database.

Records in the SI Patch or files receive change request are in drop sub-folders which associates the proper feature class and source authority business rules script. Validation Scripts can support rules and comply with NENA 71-501 Geospatial Attribute Data Validation and Topologic Data Validation, field mapping to NG9-1-1 GIS Data Model NENA-STA-006.1-2018, geocoding augmentation, and support DR handling per Section 3.4.4 DR of NENA INF 014.1-201 and 20150120 ISF NG9-1-1 GIS Data Compilation and Stewardship Charter 20151209. Each processed record will have state recorded (e.g., accepted, warning, failure) for the next step.

Once processing is complete for all ECRF computing elements, the ECRF system will notify the SI that the load was successful and make the inactive map layer active. If for some reason the load was unsuccessful, the ECRF system will pass that result along to the SI which will send out alarm notifications. If this occurs, the previously active map layer will remain active. It is recommended that new updates not be sent until the notification has been received from the SI that the previous update has finished processing.

Step 4: Publishing and Ledger Merging: Based on Transition Business Rules Design, the ledger will handle the warnings and failures per cited Governance standards, and accepted records will be identified as new, changed, same, or to be removed (Diagram 23.0.6.3).

This includes the process for publishing the LDB to support the ECRF and LVF services with zero downtime using advanced AWS Cloud publishing capability with a blue/green Cloud approach which spins down the various parallel services and spins up new services attached to the latest versioned published database (Diagram 23.0.6.4).

Based on this process, The NG9-1-1 data management processes will ensure updates to the ECRF GIS location database (LDB) are transacted with integrity and do not degrade the performance of ECRF production system response or disrupt the ECRF LoST service. The NGA 911 team plans to use a single methodology to control the update processes for both the ECRF and LVF and supporting geospatial datasets.

LVF – LDB/LIS Interactions: The authoritative LDB is maintained by the Prime and as described above NGA 911 updates and validates the Regional LDB against it. At ingress the LDB’s primary function is to support legacy ANI and pANI keys. For ANI, it returns to the LIF the fixed civic addresses already in the LDB and validated against the LVF and for pANI it first queries the Position Center (MPC, GMLC, or VPC) for a location which will be used by the NIF to build a PIDF-LO. If the pANI query does not fit within a response window; the call will be routed on the default location for the pANI (usually a cell sector centroid) which will be embedded in the PIDF-LO by reference or value depending on Cal OES specifications. In the NGCS, legacy ingress issues are handled by the LVF where the LDB is equipped to provide all available data to the LVF so the LVF presents to the ECRF the best possible “location” for routing at any given moment. To clarify, the universal ECRF will ‘always’ return a unique and consistent response to an URN and location presented to it, but the ‘quality’ of that location is dependent on its type (ANI, pANI, key, etc.), source, and the time available receive an actual location. For example, a civic address for a fixed TN in the LDB there is an absolute location provided by the LVF and a full PIDF-LO supplied (at ingress) which the ECRF responds to. But in other cases, the only information available is a trunk group name or a pANI (key) where the LVF in conjunction with the LDB provides the ECRF with a predetermined location that is not representative of caller’s ‘actual’ location but sufficient for the ECRF to return to the ESRP a URI to the serving PSAP for that pANI/key. Over time as the transition to i3 progresses a LIS in the NGCS updated by interactions with the Access Network Provider will become the main source of the initial and subsequent updated locations through the HELD protocol.

At egress the LDB also acts as a LIS for legacy PSAPs that require an LPG that supports the ALI interface. The LIS is primarily important for mobile calls to provide location updates. For legacy location updates from an MPC and GMLC that are connected to the LDB; the LDB provides a LIS function. For native i3 calls the NGA 911 LIS will be directly connected to the wireless carrier and other location sources for NG location updates.

EXHIBIT 20: TECHNICAL REQUIREMENTS NARRATIVE RESPONSE
NGA 911, LLC

Diagram 23.0.6.1 Data Ingestion - Once the file or service request is received, the received records will be queued to support data ingestion into the Region ECRF, LVF, and LDB.



EXHIBIT 20: TECHNICAL REQUIREMENTS NARRATIVE RESPONSE
NGA 911, LLC

Diagram 23.0.6.2 Data Validation & Augmentation: Each record will be processed by the associated feature class modular QC scripts written per NENA Standards/requirements based on Transition Business Rules Design to accommodate the third-party GIS data model, rules, attributes, etc.

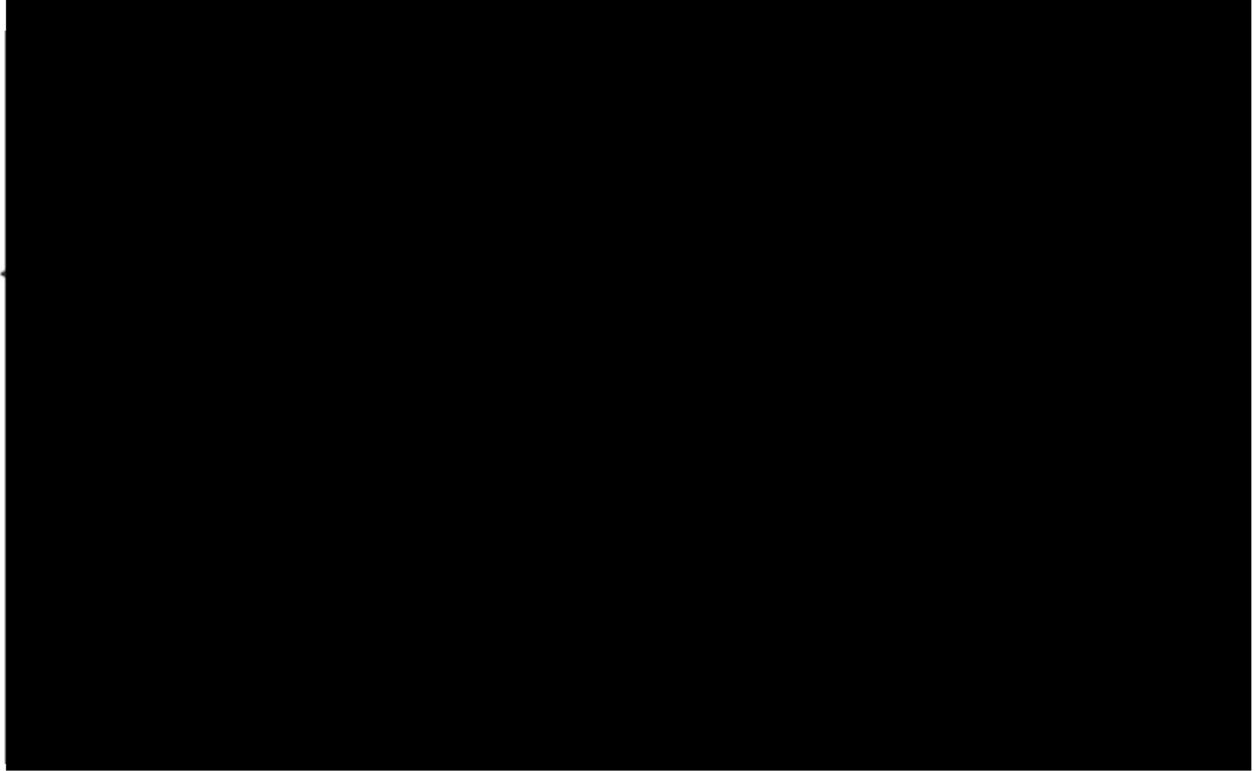

EXHIBIT 20: TECHNICAL REQUIREMENTS NARRATIVE RESPONSE
NGA 911, LLC

Diagram 23.0.6.3 Ledger Merging: Based on Transition Business Rules Design, ledger will handle the warnings and failures per cited Governance standards, and accepted records will be identified as new, changed, same, or to be removed.

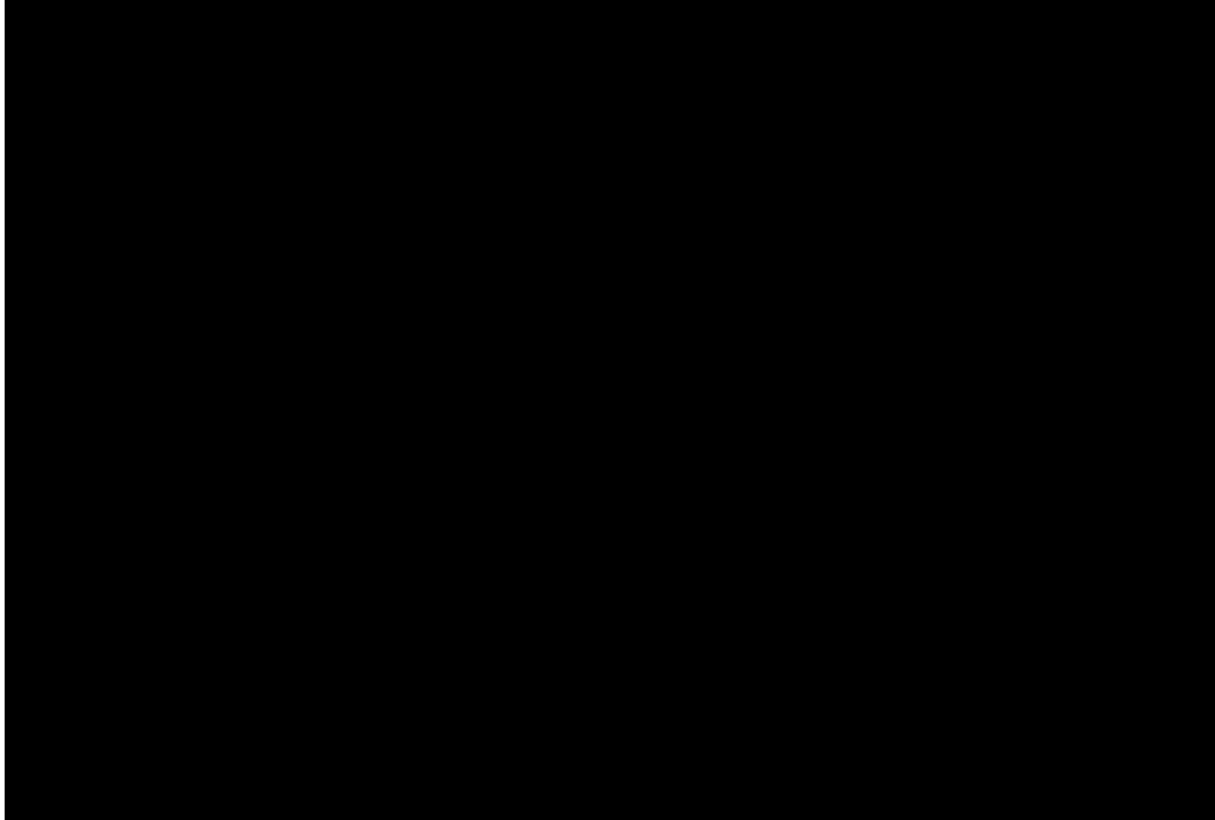

Diagram 23.06.4 Publishing to the ECRF, LVF, and LDB. spins up new services attached latest versioned published database.

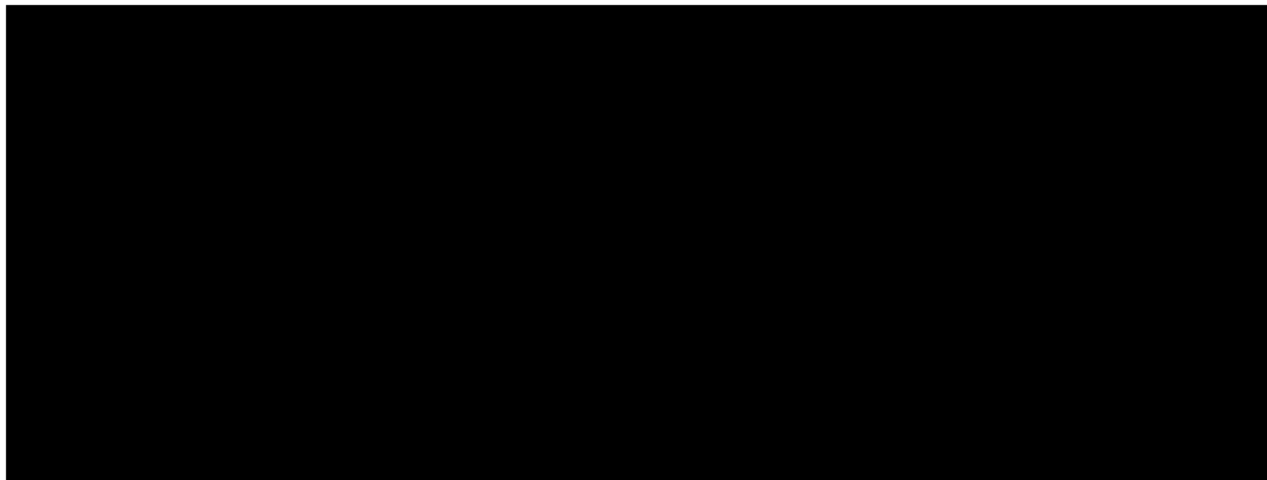

EXHIBIT 20: TECHNICAL REQUIREMENTS NARRATIVE RESPONSE

NGA 911, LLC

Exhibit 23: 23.0.7

Describe the Emergency Call Routing Function (ECRF) and Location Validation Functions (LVF) that comply with GIS standards that include but not be limited to NENA STA-010.2-2016 Detailed Functional and Interface Standards for the NENA i3 Solution. Description shall include how the ECRF will updated based on GIS changes published by the PNSP.

RESPONSE:

The NGA 911 ECRF and LVF comply with, but are not limited to the requirements of NENA STA-010.2-2016 through the use of a Spatial Interface (see 23.0.6) that consistently applies changes and updates from the statewide GIS to the NGA 911 Region(s). Changes to the statewide GIS that are first validated at the Prime and propagated to the Regional LVF (via a proxy maintained by the Prime) and the ECRF. ECRF maintenance is greatly simplified with an ECRF model based on an authoritative ECRF and LVF. The authoritative ECRF and LVF are propagate/replicate at the Prime and Regions in accordance with the processes and schedules developed during the initial SI setup (23.0.6).

The updated Regional ECRF and LVF are capable of routing ALL 9-1-1 traffic within the Region and outside the Region through the PRF by directing out of Region calls to the Prime ESRP. Furthermore, in accordance with the SOW and Regional Exhibit Requirements (23), NGA 911 adheres to the following:

OSP Management (23.1.15): NGA 911 will work with OSPs to validate the LVF maintained by PNSP to verify that civic addresses will return PSAP or emergency responder URIs. The PNSP LVF shall be made available via an LVF proxy in the public internet in a secure, controlled manner provided by the PNSP. NGA 911's LVF shall receive updates from the PNSP.

ECRF Update (23.5.1): NGA 911 will utilize the statewide GIS database maintained and updated by the NG9-1-1 Prime vendor to update the ECRF for routing all 9-1-1 traffic.

Updates from Prime (23.5.3): NGA 911 is capable of receiving updates to the GIS database from the Prime via our SI, without disruption of ECRF LoST service. Updates shall be at least daily, shall be capable of receiving data updates 24x7x365, and provide confirmation receipt of data within 4 hours.

Maintenance Function (25.5.4) NGA 911 provides a process to integrate our maintenance function to upload the data from the statewide GIS dataset to update the ECRF and LVF, ensuring proper routing of calls.

Location Routing (23.5.7): NGA 911 will route any 9-1-1 traffic to the appropriate PSAP based on geospatial data and specifically X, Y routing.

Standards Based ECRF/LVF (23.5.9): NGA 911 provides an Emergency Call Routing Function (ECRF) and Location Validation Functions (LVF) that comply with GIS standards that include but are not limited to NENA STA-010.2-2016 Detailed Functional and Interface Standards for the NENA i3 Solution.

Authoritative ECRF and LVF

Updates to NGA 911's ECRF and LVF occur through the NGA 911 provided SI off of the Prime's authoritative ECRF for the Regions. The basis for this structure is the Statewide GIS as the authoritative source for the ECRF and LVF. Given that foundation, the question that has to be addressed is how to best maintain and propagate an ECRF and LVF from the Prime for the Regions. Our SI processes (23.0.6) describe how the ECRF and LVF databases are updated and maintained. Alignment of the results when presented with a URN/Location query pair (via the LoST interface) no matter where it is situated in the California ESInet is the best way to ensure ubiquitous compliance. The advantages are that it makes it much easier to maintain for both the Prime and the Regions. The recommended hierarchy is that all ECRF and LVFs in the ESInet are based on the authoritative ECRF and LVF that is validated and updated using the Spatial Interface (SI). The active ECRF and LVFs in the Regions are verified and comply with the GIS dataset maintained by the Prime.

Centralized Policy Store - The ECRF will return a 'last hop' URI and the ESRP/PRF will rely on the PRR's from the Centralized Policy Store to determine the 'next hop' as being within the Region or requiring direction to the Prime ESRP. Managing the traffic in this way is more flexible in dealing with network changes and interruptions. In a network with a statewide GIS database but Regionally supplied and maintained ECRFs, NGA 911 believes that leveraging the PRF variables is easier to maintain, more flexible, more effective and simpler than the alternative.

How the RNSP ECRF will be updated based on GIS changes published by the PNSP

EXHIBIT 20: TECHNICAL REQUIREMENTS NARRATIVE RESPONSE

NGA 911, LLC

Regional conformance occurs through a Discrepancy Reporting (DR) process that will log at the Regional level variations in expected outcomes from a query initiated anywhere in the network. NGA 911 will also route based on the result of our Regional (updated and maintained) ECRF/LVF, and run in real-time or near real-time a validation check against the authoritative ECRF logging the results, especially discrepancies, into the DR for later review and action between Cal OES, the Prime and NGA 911's Region. The Prime will run periodic and regular validation tests on its own and the Regional ECRFs for QA/QC. NGA 911 as an RNSP will run our validations either independent of the Prime or in concert with the Prime against the authoritative ECRF maintained by the Prime on behalf of Cal OES.

The RNSP will provision a 24x7x365 service that will receive real-time statewide GIS publishing. Upon receipt of a PNSP published message, this RNSP server will automatically store, version, validate, and then activate the change in the RNSP production ECRF. If there are any exceptions encountered during this process, RNSP will not activate the change and immediately notify each stakeholder of the exception by their preferred method of notification, i.e., SMS, IM, or eMail. After handling of exceptions is complete, the change can be re-published by the PNSP to the RNSP. Upon activation, the next incoming call will route according to the newly published information, ensuring no downtime in this process.

ECRF – GIS Updating

The NG9-1-1 data management processes will ensure updates to the ECRF GIS database are transacted with integrity and do not degrade the performance of the ECRF production system response or disrupt the ECRF LoST service. The NGA 911 team will establish appropriate communication channels and coordination with Cal OES, and the Prime to support the update process. The NGA 911 team plans to use a single methodology to control the update processes for both the ECRF and LVF and supporting geospatial datasets from the statewide GIS. The same data should be used for both LVF and ECRF. The system will accommodate ad-hoc changes, expedited changes, and a standard planned update process to ensure the most recent and vital information is available to assist callers and first responders. The ESInet Data Management process and supporting technologies are designed and implemented to support multiple types of updates. These updated methods ensure that there is no performance degradation to the ECRF LoST services. Updates occur on at least a daily basis unless the update has an effective "on date." Our solution works with the statewide GIS service provider (Prime) and Cal OES to develop a viable and mutually agreeable process that addresses data quality and the specifications for ECRF administration. The ECRF data administration tool uses role-based workflow with the capacity to support staging updates, and coordinates, at a minimum, receiving data updates 24/7/365 and providing a confirmation of receipt of data within 24 hours.

Error/DR Change Management

To handle records that result in errors or warnings, a governance body review of DRs would be expected on an average weekly basis with the management and technical leads for the respective aspects of the LVF. Our management approaches will accommodate the conditions where critical discrepancies require emergency responses. Our GIS Tools will allow for approved Manual editing as required as well with a set of approved scripts and approval gates which will then use the aforementioned data pipeline process to perform the acquisition, ingestion, validation & augmentation and ledger recording.

The resolution of the discrepancy will be coordinated with the reporting agency and ESInet operational management, and/or appropriate Governance body to align with established change management procedures for data and other configuration items. We assume client governance will allow for resolution based on standing orders as well as escalated items requiring client governance intervention. The team will conform to the emerging NENA standards when finalized and will deploy the best practices of change and configuration management to maintain system integrity and data quality.

Furthermore, the results of the GIS Database will gain further input by calling our ECRF as well as a 3rd Party ECRF - e.g. the Prime (authoritative) - to add their result, and should there be a discrepancy, such will be logged such that the DR coordination will use to address data governance and management decisions.

EXHIBIT 20: TECHNICAL REQUIREMENTS NARRATIVE RESPONSE NGA 911, LLC

Diagram 23.0.7.1 Logging, Diagnostics, Reporting and Discrepancy Management

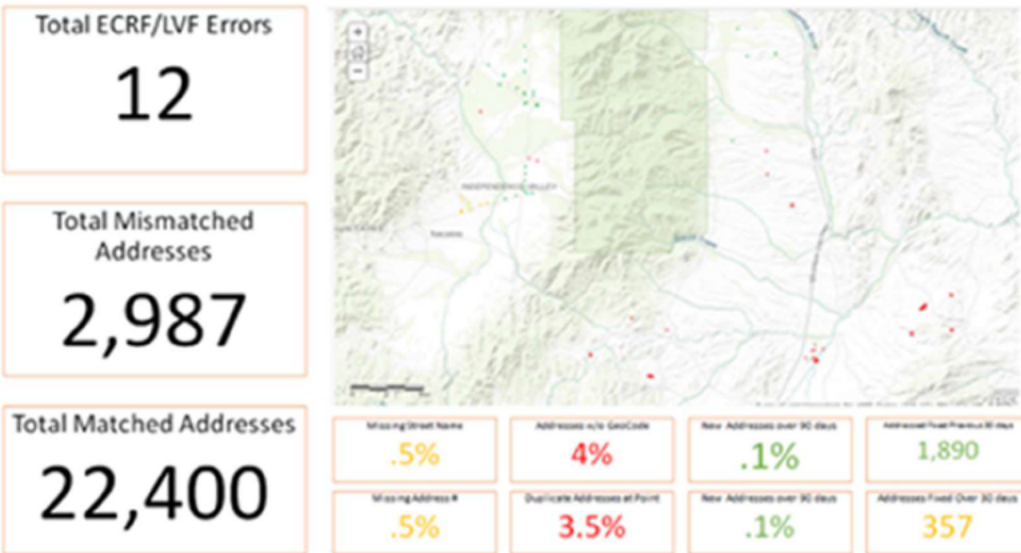
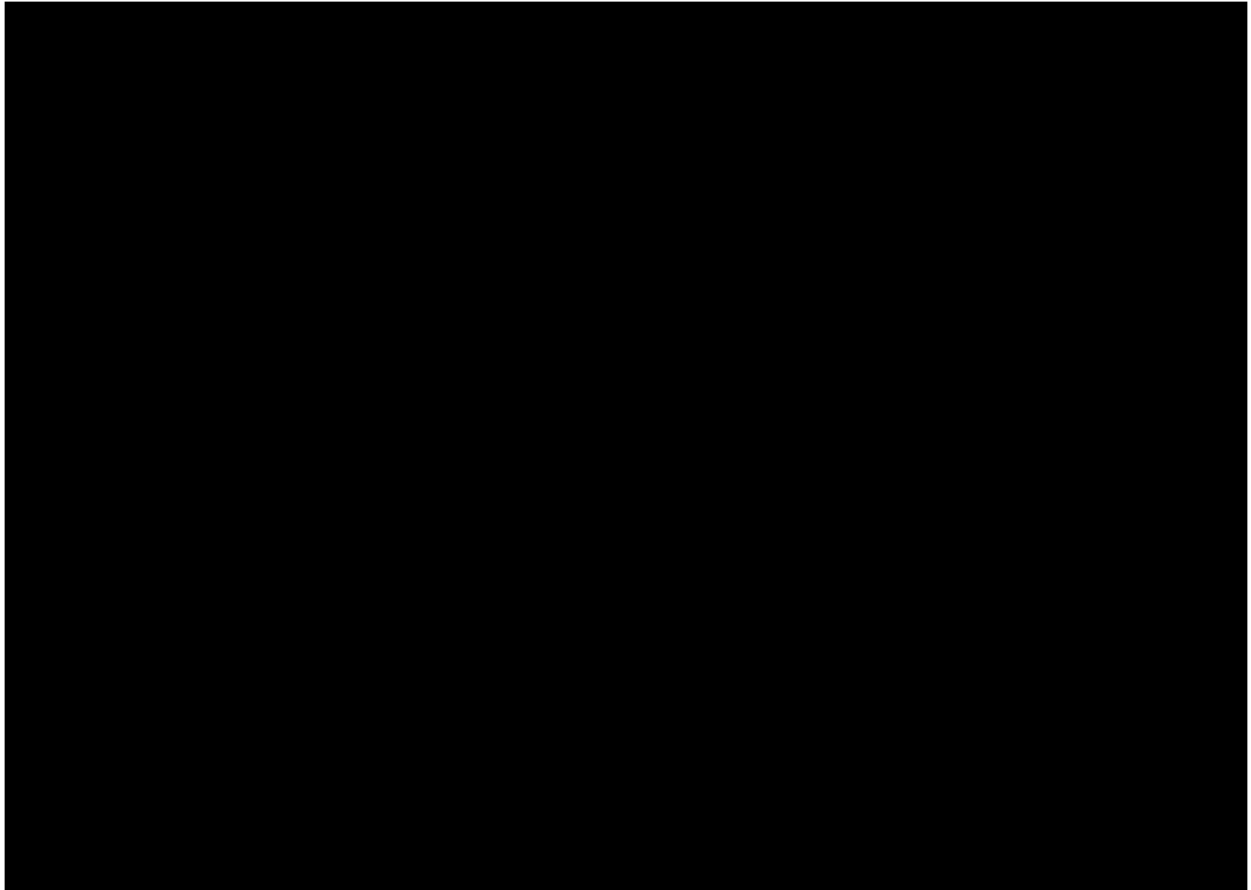

EXHIBIT 20: TECHNICAL REQUIREMENTS NARRATIVE RESPONSE

NGA 911, LLC

Exhibit 23: 23.0.7.1

List all subcontractors that will be used for ECRF/LVF. There is potential for some subcontractors to be used by multiple RNSP's or the PNSP. In that scenario, describe the bidder's strategy to prevent or mitigate one subcontractor's outage from causing an outage in multiple regions. Bidder shall describe how their solution provides an autonomous solution for ECRF/LVF.

RESPONSE:

Subcontractors for ECRF/LVF

NGA 911 will not use any subcontractors for the ECRF/LVF, so there is no possibility that another RNSP's outage would affect NGA 911 Regions as there are no interdependent resources. Our team, however, benefits from the experience, products, tools and consulting from Xentity which is assisting on the SI, data integration, and program management aspects of the ECRF/LVF integration with the Prime.

NGA 911 set forth several years ago to build the platform that would transition a network from the legacy to NG9-1-1 system. We built our platform from the ground up for this specific purpose. Every part of our NGCS is built internally with no subcontract code or systems, so there is no potential for a subcontractors' outage, whether by coding or architecture mishap, that would affect our region(s); thereby removing a point of failure, and adding an additional layer of redundancy and resilience to California's deployment.

Quality Control

Since we own every byte of code in our NGCS platform, we are fully accountable and guarantee the quality of our software code.

Triggering R&D Resources

NGA's NGCS is not exposed to the risk of external priorities, outside of NGA 911, delaying or hampering project deployment. Senior management priorities patches and bug fixes so we are not dependent upon any organizations outside of NGA 911. Simply put, a phone call to NGA 911 senior management has an immediate impact NGA 911 R&D priorities.

How NGA Provides an Autonomous Cloud Solution for ECRF/LVF

NGA 911 has demonstrated through the deployment of several ESInets that include the ECRF/LVF functional elements, that every deployment is autonomous, meaning that every deployment has independent monitoring, instances, network, and an independent build.

NGA 911 has worked with Cloud Providers over the past several years to transform their 99.95 to 99.999 availability. This process included isolating processing instances and network, and interconnecting these isolated instances in such a manner as to provide real time redundancy.

NGA's Additional Project Risk Mitigation

We fully expect that one of the risks to the IP cutover is the small details that are not known at the project's outset that impede and delay project success. While we are the only vendor who has actively pursued and engaged Carriers and PSAPs in our "Three Steps to NG9-1-1 Program," and discovered so many of these small details, and incorporated them into our NGCS, we also understand that not every detail is known at the outset of a project. So, a substantial risk to the project will be capturing and handling these small details as they impede IP cutover success. Handling these small details must be immediate, thorough, and collaborative which we have demonstrated in every one of our "Three Step Programs."

EXHIBIT 20: TECHNICAL REQUIREMENTS NARRATIVE RESPONSE NGA 911, LLC

Exhibit 23: 23.0.8

NGA 911 understands that Cal OES has had no visibility into its 9-1-1 network, and has, essentially, been operating the state's 9-1-1 network with a blindfold. 9-1-1 has been a black box, that either worked or did not work, and in fact, the existing network experiences multiple outages every month. Clearly it is a source of frustration when you are not empowered to understand, through independent investigation, "why it broke" and "what preventive steps are being taken to ensure that it does not break again".

NGA 911's Dashboard enables real time monitoring by all stakeholders of all 9-1-1 traffic and all NG9-1-1 trunks to ensure that SLAs are being met.

Cal OES will access the Dashboard via a 24x7x365 web portal. The Dashboard allows authorized all stakeholders to view reports and monitor real time health reports of the NGA 911 Region (RNSP) networks from ingress to egress.

Authorized Cal OES, PNSP (as agents of Cal OES) and PSAP personnel with appropriate privileges to the secure Administrative Portal access the dashboard monitoring system as well as reports, trouble tickets, project documentation and procedures. In collaboration with Cal OES, appropriate privileges are granted and stakeholders can login, view, and run statistical data, printable reports, outage notifications including duration.

NGA 911 exceeds this requirement because administration is configured at the end user level as authorized by Cal OES and PSAP personnel - you have the control. Further exceeding the requirements, stakeholders can gain access to event-logging and review recordings and run ad hoc statistical and other MIS reports. Even further exceeding the requirements, stakeholders can have access to overall system health, custom reports, or even view

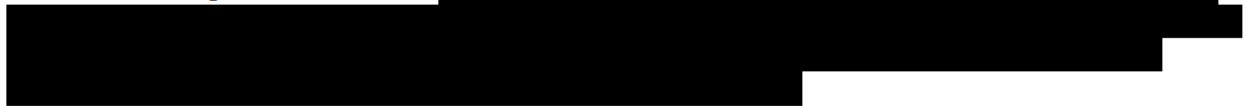

Diagram 2: Real Time Network Utilization and Monitoring Available to the State

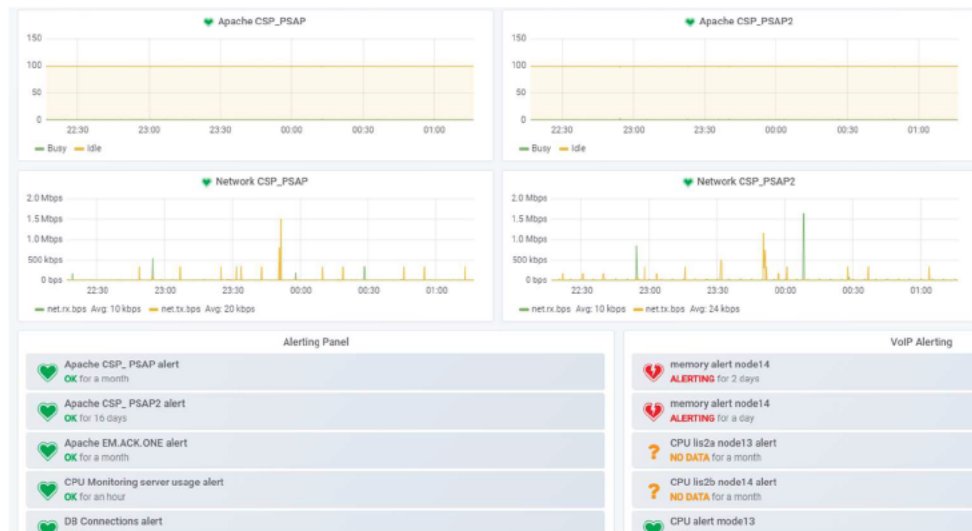

EXHIBIT 20: TECHNICAL REQUIREMENTS NARRATIVE RESPONSE
NGA 911, LLC

Exhibit 23: 23.0.9

RNSPs Monitoring and Reporting

NGA 911 as an RNSP is required to provide all system monitoring, reports, dashboards, API's (or other methods to push data) and SLAs to the PNSP. Specifically, as described in Section 1.1 of A2 RFP 6026-2018 Part_2: [the] *RNSP shall provide Regional network performance monitoring and oversight and provide access through dashboard and push data to the PNSP for statewide network monitoring.*

It is then incumbent on the PNSP to *provide network monitoring for all four (4) regional networks, using data provided by the RNSPs, in addition to the Prime Network and provide access through dashboard, per EXHIBIT 21: PRIME TECHNICAL REQUIREMENT.*

NGA 911's NOC collects, processes and reports this information providing a comprehensive view of the Regional network for which we are responsible. The NGA 911 Dashboard also delivers automated outage notification system and live system monitoring capability and outage reporting to Cal OES in accordance with the Event Notification requirements of the contract.

NGA 911's Operational Support System (OSS)

NGA 911's Network Management System (NMS) is a component of our overall OSS which is engineered to support both the Prime and Regional Reporting Systems. The NMS is fully integrated into at NGA 911's NOCs. When an Incident is detected in either the RNSP it will be processed through the OSS infrastructure. The Manager-of-Managers, Monolith, will transmit the Incident details to the integrated ticketing system to create a new ticket or update a current ticket. Instant, accurate, and automated notifications of Incidents facilitate action to protect business-critical services.

Electronic Bonding of Ticketing Systems

The RNSP trouble ticketing systems will be electronically bonded (e-Bonding) with the PNSP's statewide ticketing system. The e-Bonding of ticketing systems allows near real-time notification of issues, status and the capability of tracking or sharing of information during the restoration processes between the NOC and the PNSP and Cal OES management and support teams.

The front end of the e-Bonding interface is [REDACTED]. On the extranet, [REDACTED] provides an authenticated web service that can be utilized by customers to create tickets in the NGA 911 Incident Management application. The [REDACTED] web service (on the extranet) then calls a web service on NGA 911 Intranet. The web service will pass back data to [REDACTED] which will either pass back without change or modify/simplify and pass back. The communication between the PNSP and the GIS is synchronous and the protocol will be https.

Incident Monitoring

The NOC will provide real time remote monitoring of the supported devices, elements and network within the RNSP including:

- End to end media characteristics SLA monitoring
- NG9-1-1 Trunk monitoring
- Regional Aggregation monitoring
- Regional NGCS monitoring
- Alerting when SLA, vendor and/or manufacturer defined fault-related faults are detected, 24x7x365.

Monitoring is achieved utilizing simple network management protocol (SNMP), translation language (TL1), Representational State Transfer (REST) and/or other APIs provided by the RNSP in accordance with their reporting requirements. NGA 911 will monitor the designated target identifier (TID) or

EXHIBIT 20: TECHNICAL REQUIREMENTS NARRATIVE RESPONSE NGA 911, LLC

hostname associated with each measured component, FE, or network parameter, provided they are visible outside the Region and under the management of the NGA 911 OSS NOC platform.

Network Management Experience

NGA 911 's NOC Partner Fujitsu is a Tier 1 NOC/SOC providing services to major Telcos, cable companies, enterprises, and government from their facilities in Dallas, Chicago, and Houston:

Diagram 3: Fujitsu provides Tier I NOC/SOC to Telcos, Global Enterprises and Public Safety

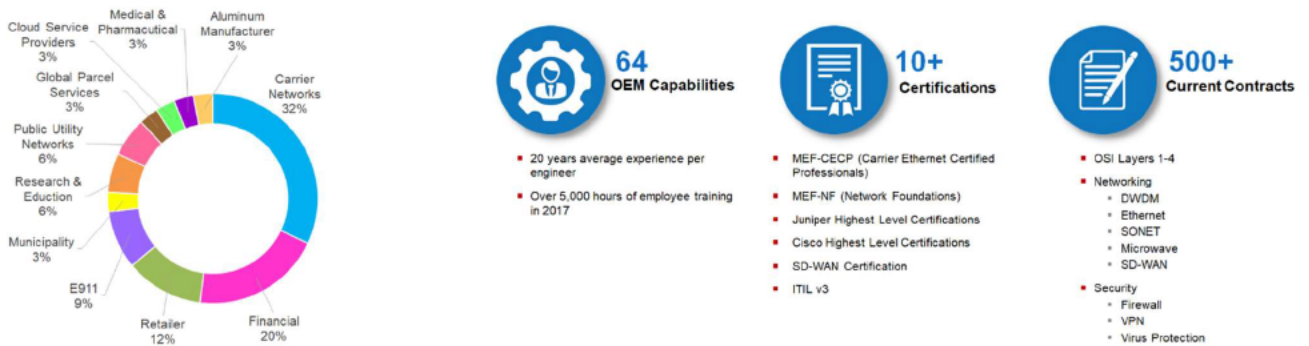

Diagram 4: Relevant Skills and Certifications

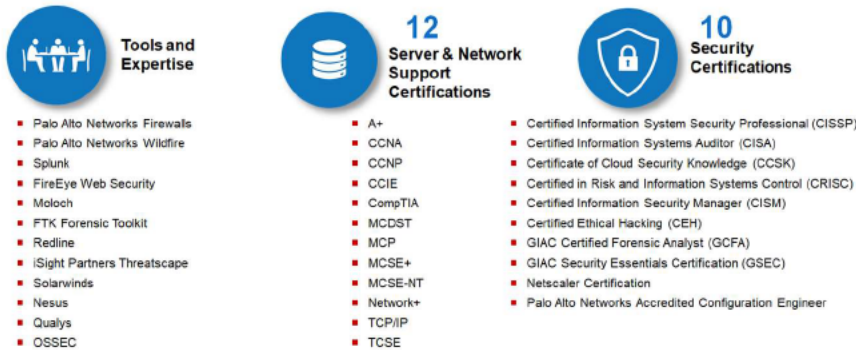

Diagram 5: Indicative 2018 Annual Performance Metrics for Network Management and Support Services



EXHIBIT 20: TECHNICAL REQUIREMENTS NARRATIVE RESPONSE NGA 911, LLC

Exhibit 23: 23.0.10

Describe realistic timeline for Dashboard development that includes at a minimum Real Time Network Outage Monitoring and Reporting to support the description given for 23.0.8.

Response:

We understand that the Real Time Network Outage Monitoring and Reporting when taken together with 8,9 and 10 provide Cal OES to unprecedented management control of service providers by being knowledgeable about the SLA compliance.

We further understand that close coordination and communication between RNSP, PNSP, and CA 9-1-1 Branch is essential for deployment of meaningful dashboards. To accomplish this task NGA 911 embraces weekly, or more frequent, in person team meetings to ensure timely deployment of dashboards and ease of use. We expect daily communication with CA 9-1-1 Branch team until the dashboards fully serve the requirements of Cal OES. Followed by less frequent, monthly in person outage reviews on a monthly basis after successful implementation.

NGA 911 has a collection of Dashboards available from day one. NGA 911 and Cal OES will meet to review the options (many detailed below) and select the individual or combination of screens that best convey the desired information. Development of the initial Dashboard framework is complete and ready to deploy upon contract award. However, while the framework is in place the actual measurement data and monitoring functionality will be made available as the network rolls out and traffic begins traversing the ESInet. As the network rolls out, NG9-1-1 Trunks, Aggregation and NGCS FE's, RNSP interfaces, and PSAPs analytics will be added to the dashboard. Furthermore, NGA 911 will work with Cal OES to modify reporting and monitoring and customize it to their specific needs.

Dashboard Available Immediately: Leveraging SD WAN technology, Real-Time Network Outage Monitoring and Reporting Dashboard is available 24/7/365 to all Region stakeholders as set forth by Cal OES. NGA 911 will place trunk orders, 60 days later when the trunks are provisioned and the routers come online in the Region; the monitoring analytics will be immediately pushed to the PNSP's designated endpoint as well, so the PNSP can construct their interface to regional network monitoring.

Regarding Outage Notifications, the Dashboard is already connected to our real-time communication console so that all outages that potentially impact the delivery of 9-1-1 traffic will be reported and notifications triggered within a maximum of ten (10) minutes of the occurrence. and escalation notification to all stakeholders with transparent access to issue tracking, root cause analysis, and resolution; further, the Dashboard is already connected to our real-time business intelligence, analytics, and data warehouse for immediate reporting and analysis.

Immediate 24x7x365 Access as Circuits Brought Online: More specifically, as soon as the routers are brought online the following information will be available and procedures activated that are dedicated resources for California: (i) on demand reports, performance measurements, and system status; (ii) the dashboard will provide a view of system operation and data metrics including uptime and downtime; (iii) outage notifications to CA 9-1-1 Branch will be immediately activated, available on the dashboard, and include duration; (iv) throughput statistics of NG Trunks will be available in real-time; (v) and, as all routers in the entire call path are brought online the dashboard will display and report the health of the Regional networks from ingress to egress to support failover interoperability. Troubleshooting to the underlying service providers will commence once eBonding with each is completed as detailed in 23.0.9.

Role of Cal OES: While development is not necessary to achieve the aforementioned function points, except possible adjustments for PNSP integration, configuration and training will be essential. Cal OES will receive training on the Dashboard. Feedback collected during these training sessions will improve the usability of the Dashboard. Further, we do expect that additional reports will be requested by Cal OES to assist in streamlining their SLA enforcement program. We guarantee, through an iterative process, these dashboards will align perfectly with the needs of Cal OES upon conclusion of this process.

Immediate 24x7x365 Access as NGCS Starts Routing Test or Live Traffic: As the NGCS functional elements are utilized, via test or live traffic, the following monitoring and reporting is immediately available to the PNSP and

EXHIBIT 20: TECHNICAL REQUIREMENTS NARRATIVE RESPONSE
NGA 911, LLC

all stakeholders (no development is necessary although we expect to tweak output streams to accommodate PNSP integration): (i) 9-1-1 metadata traffic and NENA i3 functional elements logging; (ii) SIP metadata to monitor, track and verify data flow; (iii) and, all transparent, real time visibility of all RNSP 9-1-1 traffic.

The Dashboard and its associated transparency are vital to project success for all stakeholders during both test and live because issues must be identified immediately and handled transparency so that a strong knowledge base can be created to operate this new NG9-1-1 solution for the state.

Available Real Time for Print, PDF, or CSV: The statistical data in different categories can also be printed or exported to a CSV file for additional data analysis. PDF reports can also be generated.

The top-level categories displayable dashboards on the top-level screen consist of the following (See Diagram 23.0.10.2 for examples of the below):

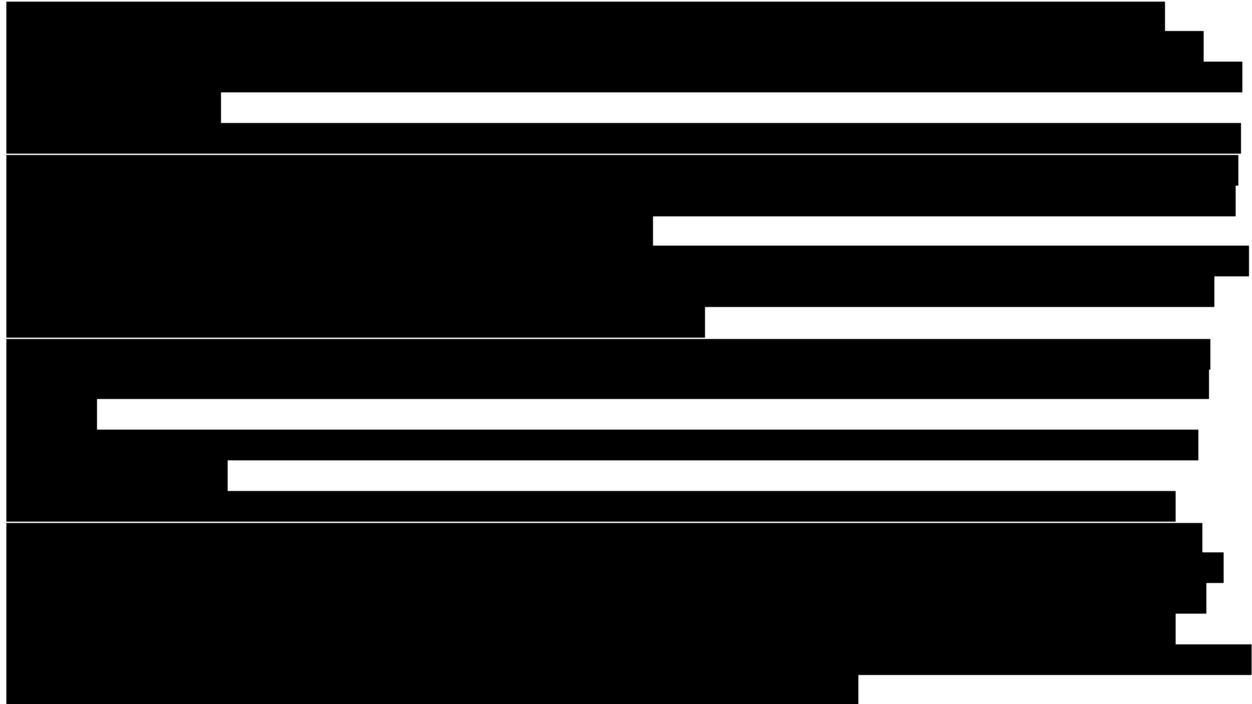

Retention: All reporting shall be archived and available for a minimum of ten years.

EXHIBIT 20: TECHNICAL REQUIREMENTS NARRATIVE RESPONSE
NGA 911, LLC

Diagram: Timeline for Circuit Monitoring in the Existing Dashboard

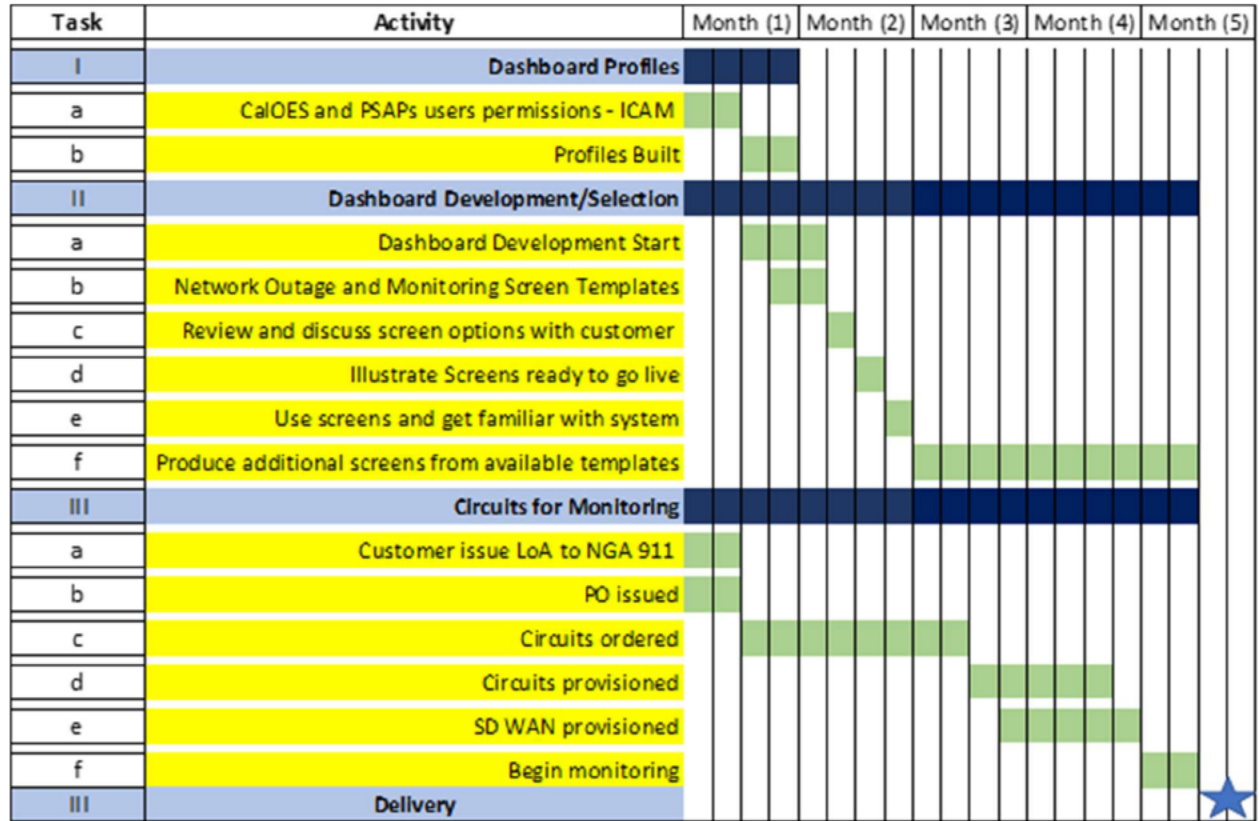

EXHIBIT 20: TECHNICAL REQUIREMENTS NARRATIVE RESPONSE
NGA 911, LLC

Diagram 23.0.10.2 SD-WAN Example Network and Performance Monitoring Screenshots

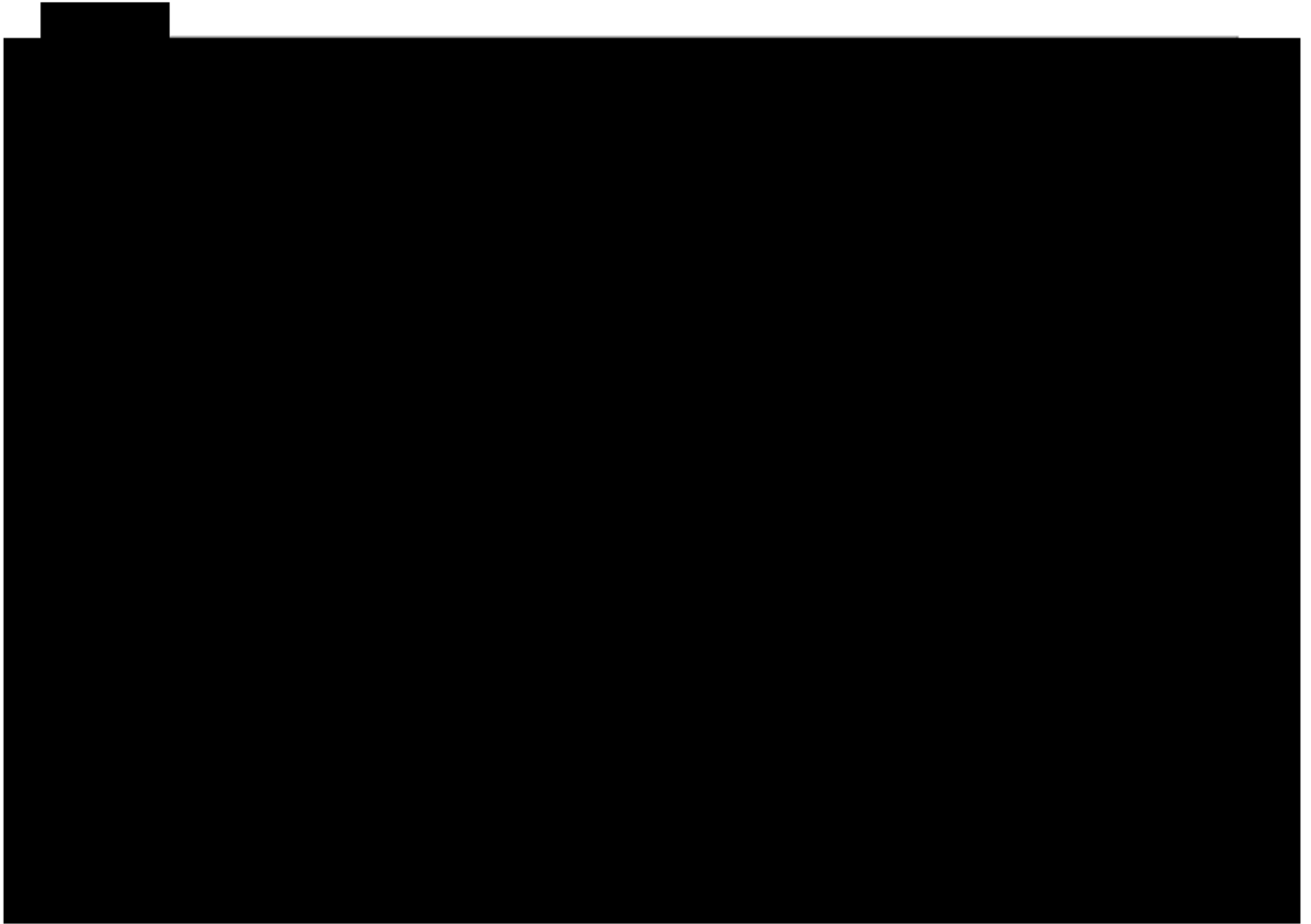

EXHIBIT 20: TECHNICAL REQUIREMENTS NARRATIVE RESPONSE
NGA 911, LLC

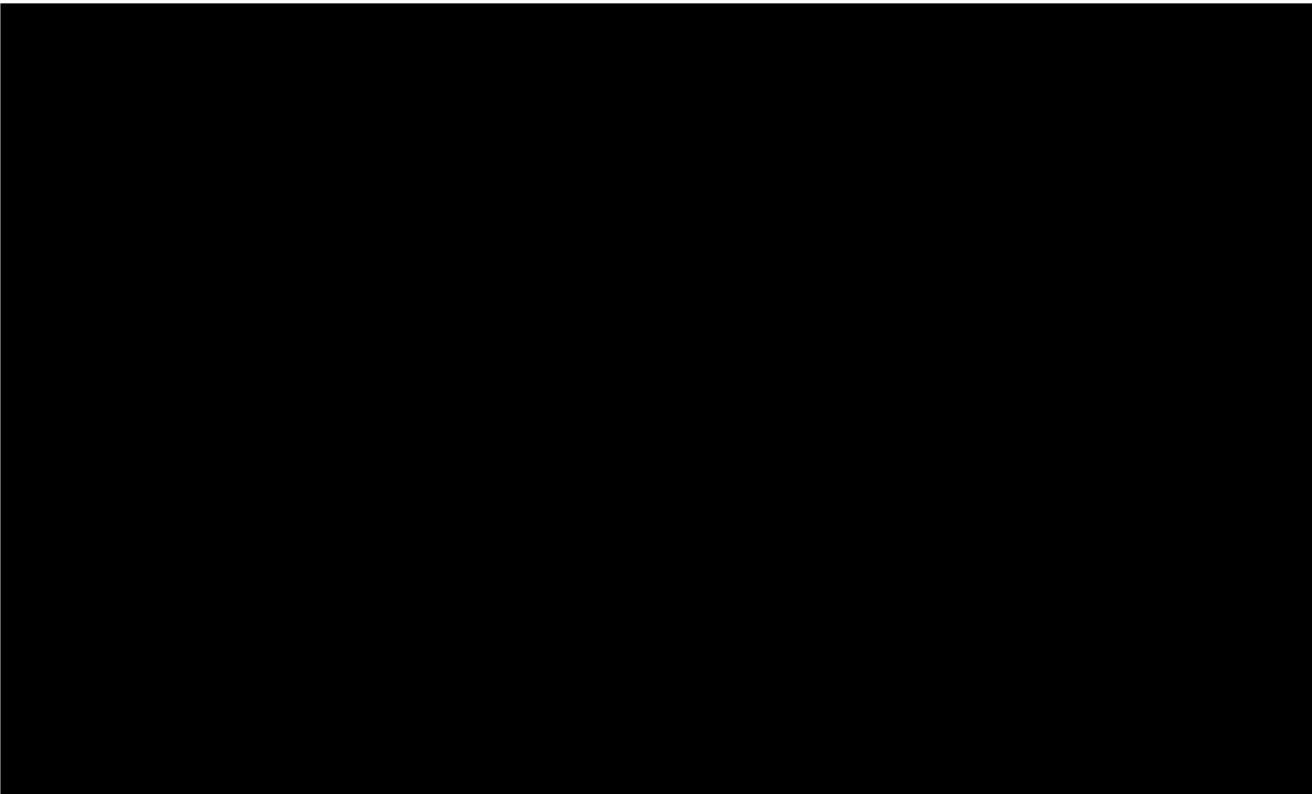
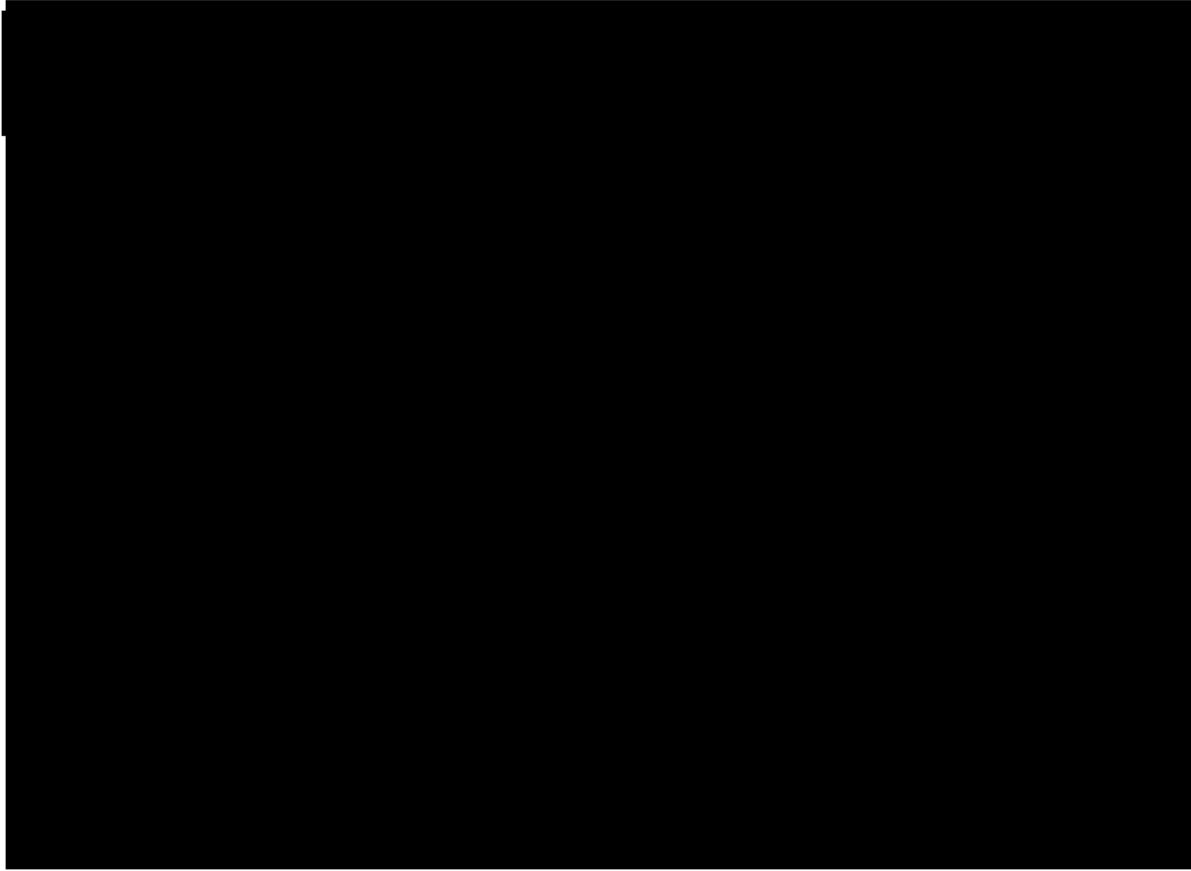

EXHIBIT 20: TECHNICAL REQUIREMENTS NARRATIVE RESPONSE
NGA 911, LLC

Exhibit 23: 23.0.11

Describe the OSP traffic aggregation service for all wireless, AT&T wireline, Consolidated Communications wireline, and Frontier wireline OSPs in the awarded region in the State of California. Describe how the POI locations will be determined to support the ingress of OSP traffic, and how they will work with the OSP, CA 9-1-1 Branch and the CPUC throughout this process.

RESPONSE:

Construction of SS7 and SIP Aggregation Points, along with the conversion of SS7 to SIP, in the Region are critical milestones of the IP cutover strategy where the Selective Router is entirely removed from every aspect of 911 call processing, and there is no role for an LSRG.

In collaboration and close coordination with Cal OES and the Prime, as well as in conformance with jointly developed standards and interfaces, NGA 911's construction of aggregation and conversion processes in regions will process and route all wireless, AT&T wireline, Consolidated Communications wireline, and Frontier wireline OSP traffic, along with any other 911 traffic not handled by the PNSP.

Legacy and SIP Aggregation Services are Mutually Exclusive Services: NGA 911 provides both Legacy and i3 aggregation services for all the Wireless and ILECs in the state and/or assigned region(s). For Legacy, NGA 911 will identify POIs for legacy traffic to convert to i3 through a fully functional LNG (PIF at POI, NIF, and LIF at Aggregation Point) supported by an LDB/LIS (see Diagram 23.0.11.1.1 for wireline and 23.0.11.2 for legacy wireless). The location of the TDM POIs is dependent upon several factors detailed in this section below. For i3 the SIP Ingress will be co-located with the Regional Aggregation Points. NGA 911 will engage Cal OES and the CPUC throughout the process to ensure the expedient ingress of carrier 911 traffic to the POI.

Legacy SS7 Aggregation & POI Locations: The demarc for the ILEC is at the POI; all E911 wireless, AT&T wireline, Consolidated Communications wireline, and Frontier wireline OSPs will ingress the next gen network here. NGA has retained Inteliquent, a CPCN holder, to construct SS7 aggregation services. Where appropriate NGA will aggregate traffic itself, purchase, and install off the shelf LNGs for the conversion of SS7 traffic, and subsequent transmittal to either regional SIP Aggregation Point or, upon failure of both in the Region, the Prime Aggregation Point.

Redundant (at least two) TDM POIs established in the region will process SS7 calls using an LNG and deliver them to the SIP Aggregation Point. The LNGs perform protocol conversion and pass the call to the BCF at the SIP Aggregation Point within the awarded region. Note that the LNGs and BCFs in an awarded Region are interconnected. LNGs can pass calls to either SIP Aggregation Point in the Region.

OSPs requiring TDM interconnection are generally sensitive to the distance from their end office to the TDM POI and are typically opposed to crossing LATA boundaries. The location of TDM POIs will be determined after the initial outreach to the OSPs. NGA 911 will likely recommend the TDM POIs in the LATA with the greatest number of TDM OSP end offices. However, NGA 911 will present all options to Cal OES before making a final decision.

Collectively, the OSPs interconnecting to the Legacy/SS7 Regional Aggregation System have an average of over 125 end offices per region. TDM POIs offered in the proposal have a maximum capacity of 56 T1 connections. If the end office count for all OSPs interconnecting via TDM is greater than 56, Cal OES will need to purchase additional TDM POIs. To stay below the 56 T1 threshold, POI Locations will be selected based on the outcome of the OSP outreach. TDM POIs will likely deploy in the LATA with the greatest number of Regional OSP end office TDM switches. If Regional OSPs require TDM POIs in other LATAs, NGA 911 will work with Cal OES to determine if additional TDM POIs are necessary. NGA 911 has access to existing TDM POIs in every LATA in California, so adding more will not require a material amount of extra time and can be accomplished at the tariff price.

POI Interconnection with PNSP: POIs are either collocated at the SIP Aggregation Point or connected after conversion to SIP via an NG9-1-1 Tariffed Trunk. Should all regional aggregation points fail, the POI at the egress of the LNG will route traffic to the PNSP Aggregation Services.

EXHIBIT 20: TECHNICAL REQUIREMENTS NARRATIVE RESPONSE NGA 911, LLC

Regional SIP Aggregation Point: NGA's softswitch uses a combination of Kamailio and Freeswitch as the foundational building blocks of the SIP Aggregation Point. SIP Aggregation functionality includes BCF, B2BUA, Media Traffic Management, Monitoring, Evaluating, Responding and Reporting, as well as RFC 5853 functionality, namely: (i) Topology Hiding, (ii) Media Traffic Management, (iii) Fixing Capability Mismatches, (iv) Maintaining SIP-Related NAT Bindings, (v) Access Control, and (vi) Media Encryption. NGA 911's solution uses the Peering Scenario. Further details are provided in 23.0.14.

Regional NGCS Failure: By anchoring the call at the RNSP SIP AP, the RNSP can determine if Regional NGCS is available to reach the PSAP. If PSAP is not reachable via the Regional NGCS, then the call goes to the PNSP for delivery to the PSAP (see 23.0.2 Correct PSAP Routing for more details).

Redundant SIP Aggregation Points: At least two SIP Aggregation Points in a region are networked so both ingress and egress 911 traffic have redundancy and no single point of failure. If network connections from the regional BCF to the NGA 9-1-1 NGCS are unavailable, the BCF can send the call to the other BCF for delivery. The proposed architecture is entirely scalable. Consistent with the tariffed items, additional TDM and SIP POIs can be added as can LNGs, BCFs and network facilities. There are no points at which the architecture must change or require items not included in the Tariff.

Egress of SIP Aggregation 911 Traffic, Failure Conditions, and Ingress of PNSP Traffic: The SIP Aggregation Point delivers calls to the NGA 9-1-1 NGCS. Should all regional NGCS cores fail, the SIP Aggregation Point, at the egress of the Aggregation Point, will route traffic to the PNSP NGCS for delivery to the PSAP. Additionally, the RNSP SIP Aggregation Point provides a backup for PNSP traffic routing. Should the PNSP fail to route to the PSAP, then the PNSP will route traffic to the RNSP SIP Aggregation Point for delivery to the PSAP.

Interaction between POI and SIP Aggregation: Legacy non IP calls will be directed through the POI or POIs for the Protocol Interworking Function (PIF). The SIP Aggregation Service is aware of the source and additional networking and location requirements of all calls arriving from the POIs. These are characterized and serviced by OSP, call type, trunk source, key data (ESRK, ESRD, TN, etc), caller ID, etc. Each and every POI client (OSP) will be initially integrated, tested and validated for PIF, NIF, and LIF prior to being accepted and put into normal operation. See Diagram 23.0.11.1 for legacy landline conversion between the POI and Aggregation Service. Diagram 23.0.11.2 for legacy E911 conversion between POI and Aggregation Service.

OSP Outreach to Connect to POI: Outreach to all OSPs begins with an information package to the engineering and regulatory staff. Follow-up calls with each OSP will be scheduled to answer initial questions. Additional calls will be scheduled to plan for the OSP's migration to the NG9-1-1 system.

CPUC and OSP Liaisons: Anita Taff-Rice and Tom Hicks are retained by NGA 911 to serve as the liaison between NGA 911, OSPs, and the CPUC. Between them they possess a wealth of experience handling legal issues in the telecommunications industry. Taff-Rice will ensure strong communication and close coordination with the CPUC as well as participating in proceeding with the CPUC to ensure conformance with the standards and the policies of Cal OES. Hicks will ensure that the state maintains optimum advantage with the OSPs.

Additional OSP Integration Opportunities (Diagram 23.0.11.2): The Region Aggregation Service proposed by NGA 911 is designed to expedite the OSPs migration to the preferred interconnection based on SIP NENA i3 (including PIDF-LO). NGA 911 has already conducted or is in the process of conducting testing with major wireless OSPs and one of the major VoIP (Cable) OSPs to provide direct interconnection based on SIP NENA i3 (PIDF-LO/HELD). Already one of these OSPs expressed a clear willingness and desire to move to i3 stating "we have been looking for an NGCS to test and validate these capabilities we have in our lab". NGA 911 as Regional Aggregator working together with Cal OES and the CPUC, is in a unique position to move this project from the lab to real world operation and accelerate arrival at NENA end state. The resulting momentum is likely to drive additional interest from the major wireless, LECs that have converted to SIP and VoIP OSPs to doing the same.

EXHIBIT 20: TECHNICAL REQUIREMENTS NARRATIVE RESPONSE NGA 911, LLC

Diagram 23.0.11.1 OSP Legacy Landline Signaling and Media Conversion and Transcoding

1. Legacy

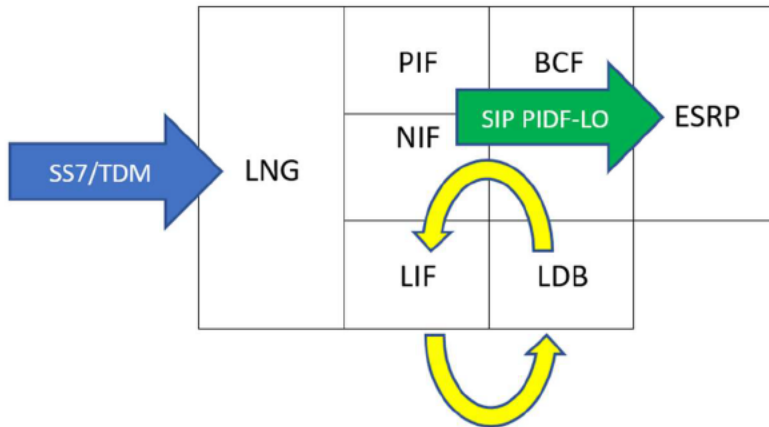
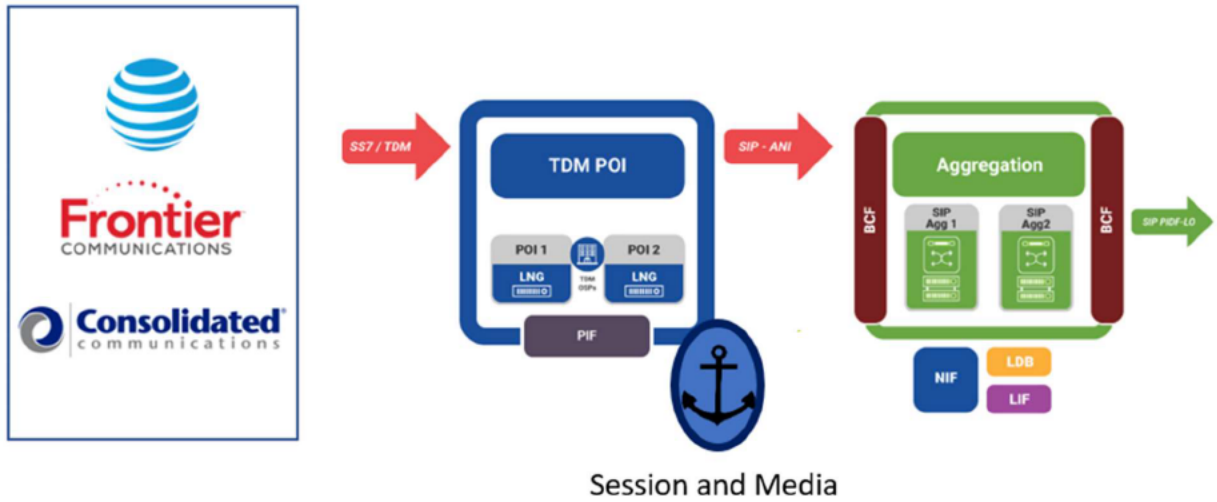

There are many implementations for the LNG, depending on the specific functions required. The diagram below is indicative of the LNG for use with legacy PSTN wireline calls where the LDB has been updated with and replaces the MSAG. The incoming call is converted by the PIF (protocol interworking function) to SIP, the LIF (location interworking function) using the TN (telephone number) of the incoming call queries the LDB for the civic address which the NIF (network interworking function) converts to a PIDF-LO and directs an i3 SIP Header to the ESRP on the other side of the BCF.

EXHIBIT 20: TECHNICAL REQUIREMENTS NARRATIVE RESPONSE
NGA 911, LLC

2. E911 Wireless Signaling and Media Conversion

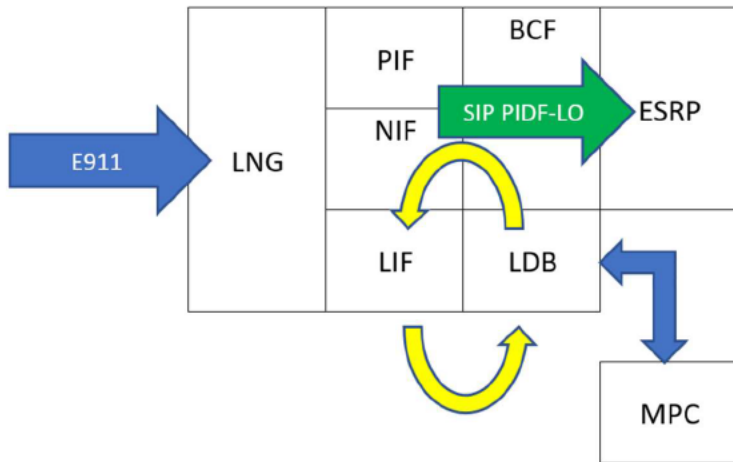
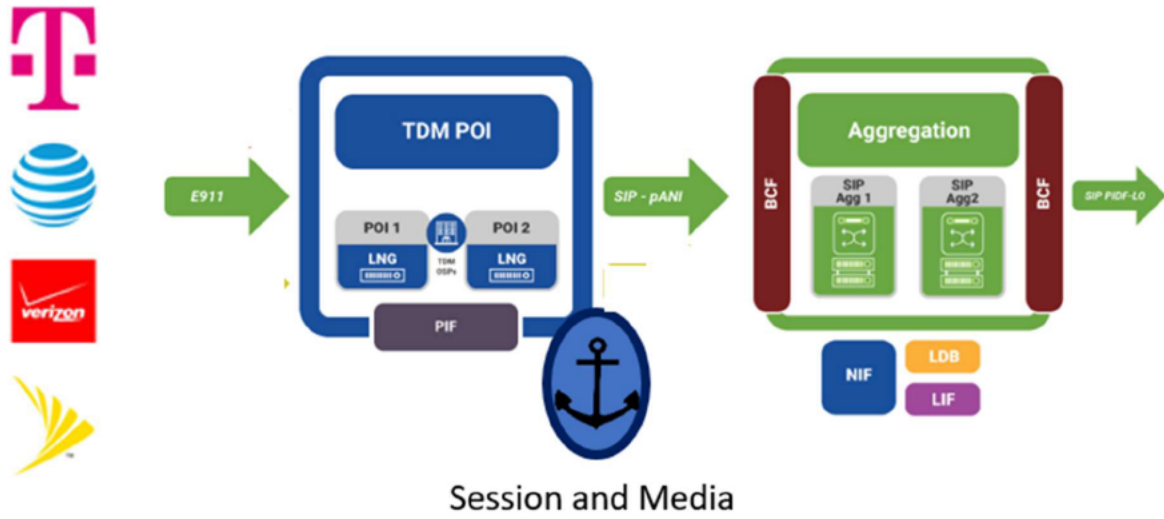
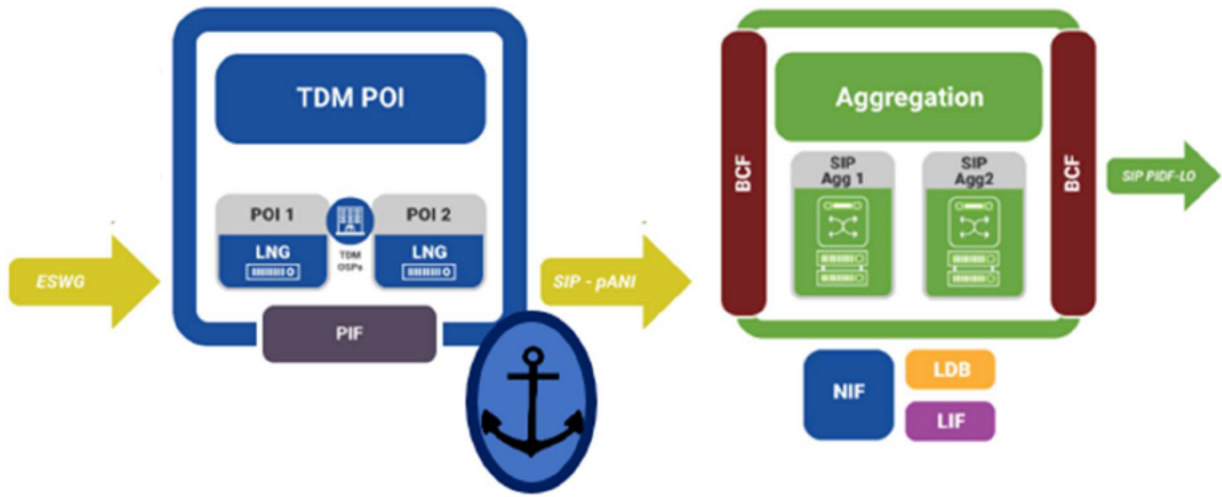

EXHIBIT 20: TECHNICAL REQUIREMENTS NARRATIVE RESPONSE
NGA 911, LLC

- 3. VoIP (if at all required due to ILEC conversion to VoIP)
 - a. ESWG Case:



Session and Media

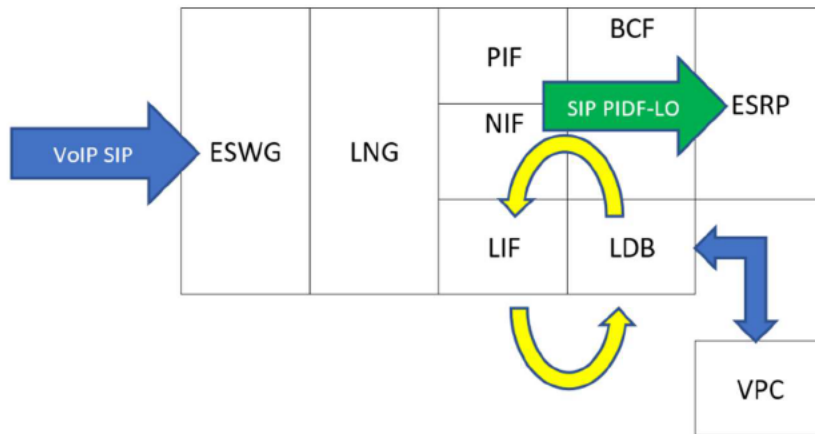
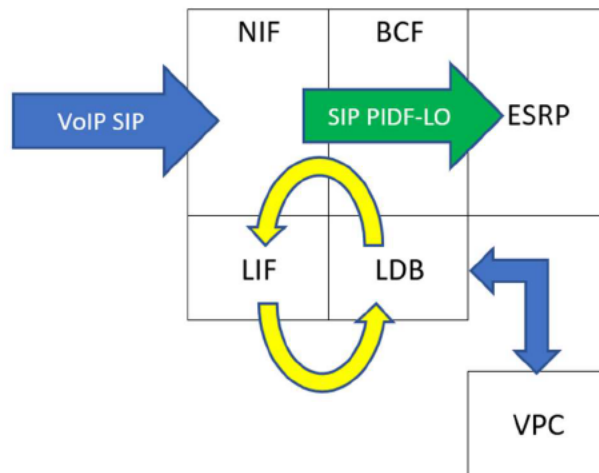
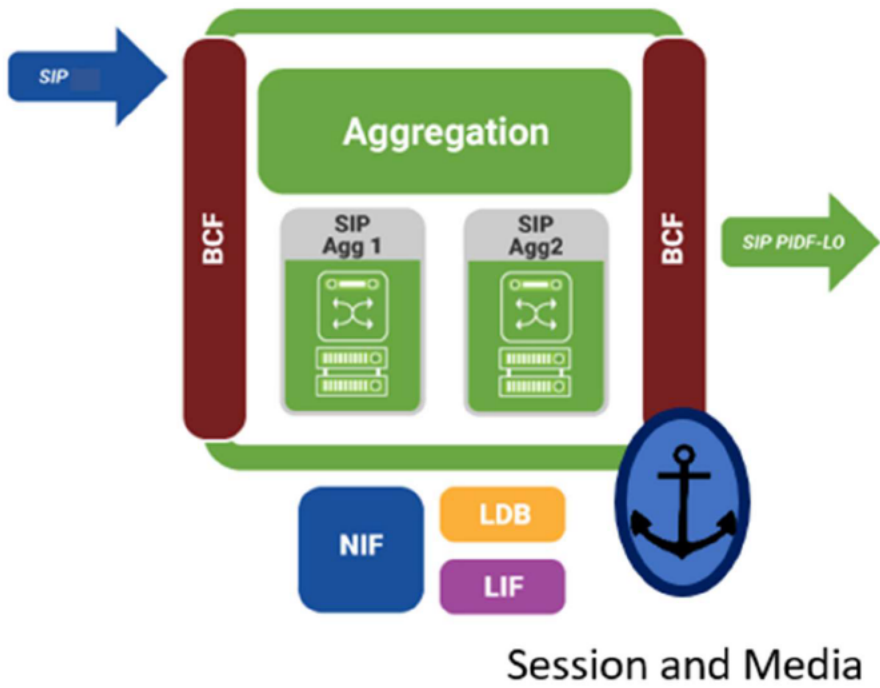

EXHIBIT 20: TECHNICAL REQUIREMENTS NARRATIVE RESPONSE
NGA 911, LLC

(b) VoIP i2 Case:



An LPG is generally positioned at the PSAP in support of non SIP (i2 or i3) legacy CPE.

EXHIBIT 20: TECHNICAL REQUIREMENTS NARRATIVE RESPONSE
NGA 911, LLC

Diagram 23.0.11.2 Direct native i3 to Regional Aggregation Point.

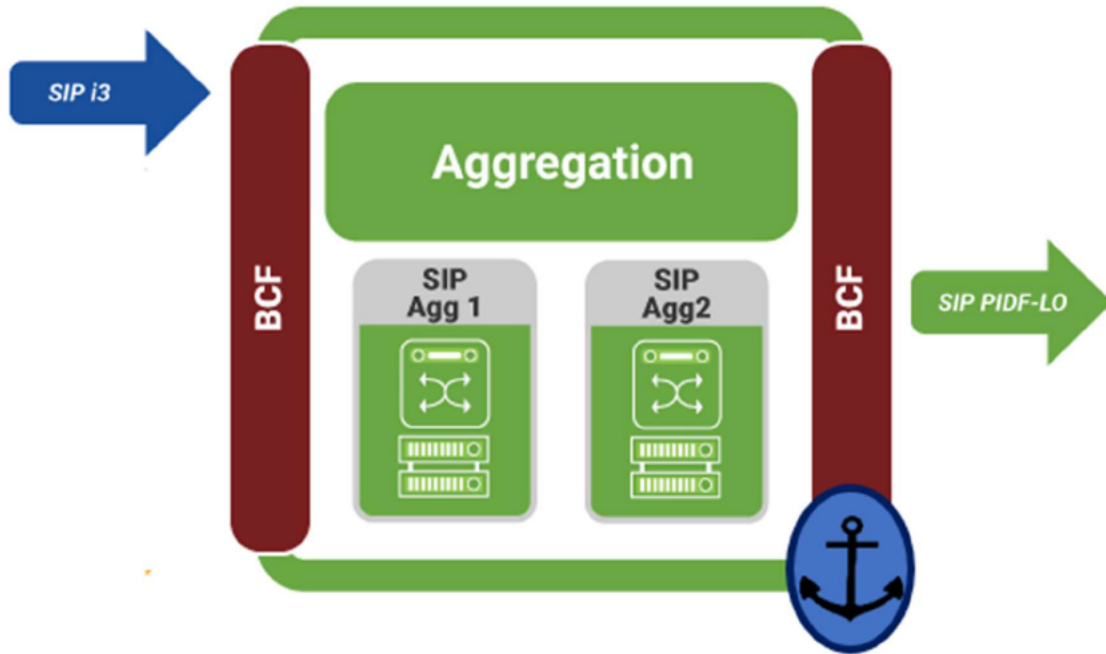

EXHIBIT 20: TECHNICAL REQUIREMENTS NARRATIVE RESPONSE
NGA 911, LLC

Exhibit 23: 23.0.12

Describe how the bidders proposed aggregation plan complies with the SOW and Exhibit 23. Description shall include the solutions ability to transfer between regions, or if PSAP is not reachable then shall send to Prime for delivery to PSAP.

RESPONSE:

NGA 911's proposed Aggregation service deploys all required functional elements and delivers all functionality detailed in the RFP SOW and Exhibit 23. We anticipate that at some point during the term of the contract, OSPs will seek to ingress directly by SIP to California's Aggregation Points. NGA 911's aggregation points support this eventuality (see 23.0.11). However, in the near term, support for OSPs that must interconnect via TDM is essential for the IP cutover strategy. By locating the LNG at the POI, NGA 911 eliminates the need for any TDM trunks and instead relies on tariffed NG 911 Trunks to connect any POIs (SS7 Aggregation Points) to the SIP Aggregation Service that are not already colocated in the same Data Center.

NGA 911's Proposed Aggregation Plan complies with the SOW and Exhibit 23:

1. Both NGA 911 and Inteliquent have a CPCN. Additionally, appropriate tariff filings for the services described are underway with the CPUC and expect to comply with the timelines set forth in the RFP. NGA 911 will maintain the CPCN for the life of the contract and will ensure its subcontractor for aggregations maintains their CPCN.
2. NGA 911 proposed Aggregation Services provides OSP traffic aggregation service for all wireless, AT&T wireline, Consolidated Communications Wireline, and Frontier wireline OSPs. These services will be rolled out in the state in close coordination, cooperation, and communication with Cal OES and the PNSP.
3. We propose a minimum of two (2) geographically diverse aggregation locations. We further propose a minimum of two (2) POIs. We understand that it is essential to eliminate any single point of failure and ensure the construction of a resilient architecture throughout every aspect of our solution.
4. In the interest of resilience, a network interconnection between the RNSP and PNSP will be created. NGA 911 will connect to the PNSP Aggregation Service to support the ingress of OSP traffic from the PNSP and egress of traffic to the PNSP. Through the adherence to be jointly developed by Cal OES, PNSP, and RNSP, traffic will flow seamlessly between the Prime and Region networks
5. In further deepening the resilience of the system, if a region's PSAP is not available through the Regional NGCS, but the Regional ESRP/PRF are available, then the 'first hop' will be through the Regional NGCS and then to the Prime ESRP for delivery to the PSAP.
6. It is critical to the success of the project that NGA 911 conform to the jointly developed integration standards as set forth by Cal OES and the PNSP for Aggregation Services.
7. Per narrative response 23.0.10, NGA's system monitoring dashboard will provide monitoring and notifications for all aspects of the system. The Dashboard includes outage notifications with duration, including aggregation services discussed in this narrative.

RNSP Aggregation Service Diversion to the Prime (Diagram 23.0.12.1)

As Required, all calls will be anchored at the Regional Aggregation BCFs. The BCF will determine if the Regional NGCS can deliver calls to the target PSAP (see 23.0.2, 23.0.11, and 23.0.15). This is accomplished via the signaling from the Aggregation BCF to the RNSP BCF/ESRP. If the Regional NGCS does not signal that it is capable of delivering the call to the target PSAP or does not respond to a SIP INVITE, the Regional Aggregation Service will send the call to the Prime NGCS. These calls will be carried over diverse and redundant network facilities between the Border Control Functions and the Prime NGCS systems procured off the NG Trunk tariff. NGA 911 will acquire and deploy the additional network facilities to the Prime NGCS facility. In this case, NGA 911 will take responsibility for the availability SLA of 99.999% from the point of OSP ingress to the handoff at the NGCS Facility. Section 23.0.2 details the diversion of calls to the PNSP, if the RNSP is not able to reach the target PSAP.

Importance of Trunk Group Naming Conventions: Naming of individual trunks or trunk groups can be used for rudimentary call routing. The naming convention used can help in determining the origin of a call for operational

EXHIBIT 20: TECHNICAL REQUIREMENTS NARRATIVE RESPONSE
NGA 911, LLC

reasons and if necessary, to direct calls with missing or corrupted location data where a destination PSAP cannot be determined to a failover PSAP or equivalent.

RNSP Aggregation Services Routing to another Region.

The Regional, Border Control Functions, SIP Aggregation Points, and Legacy Network Gateways (using NG Trunks) can, at the direction of Cal OES, be interconnected with all other Regional Aggregation facilities and the Prime Aggregation Facility to facilitate direct routing and transfer of calls from the NGA 911 Region to another Region (inter-Region call routing) - Diagram 23.0.12.2. NGA 911 will deploy these additional interconnections as requested by the Cal OES. Interconnection will be accomplished using diverse and redundant 1,000 Mbps network facilities procured off the NG Trunk tariff. NGA 911 proposes using the interconnection to add paths between the Border Control Functions and the target NGCS systems. The additional paths can add to the overall system resiliency and availability. For calls originated on the NGA 911 Aggregation Network, NIF and LIF capabilities will need to be made available **to other Regions if full i3 of legacy calls is to be made available.**

OSS Event Monitoring and Route Diversion Triggers See section 23.0.2 PSAP Routing for a description of the NGA NOC/SOC OSS continuous monitoring of the status of the network and functional elements in the ESInet to facilitate call routing in the event of failure. Additionally, the Aggregation BCF (23.0.11) maintains and reacts to the session state of every connection so that any failure at the Prime, the Region, and other connected Regions is immediately identified and the call routed appropriately as described above.

EXHIBIT 20: TECHNICAL REQUIREMENTS NARRATIVE RESPONSE
NGA 911, LLC

Diagram 23.0.12.1: RNSP Aggregation Service Diversion to the Prime

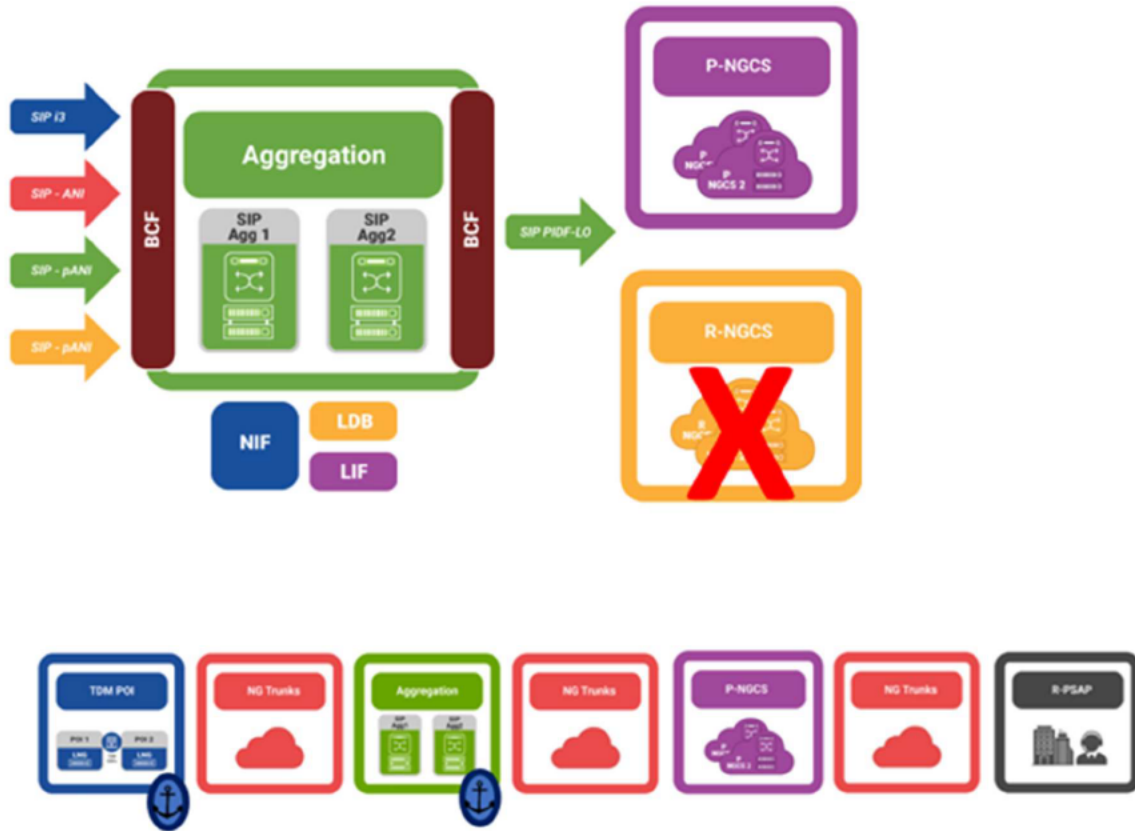

EXHIBIT 20: TECHNICAL REQUIREMENTS NARRATIVE RESPONSE
NGA 911, LLC

Diagram 23.0.12.2: Proposed Regional Architecture for a fully Meshed Aggregation Model to Prime and Other Regions.

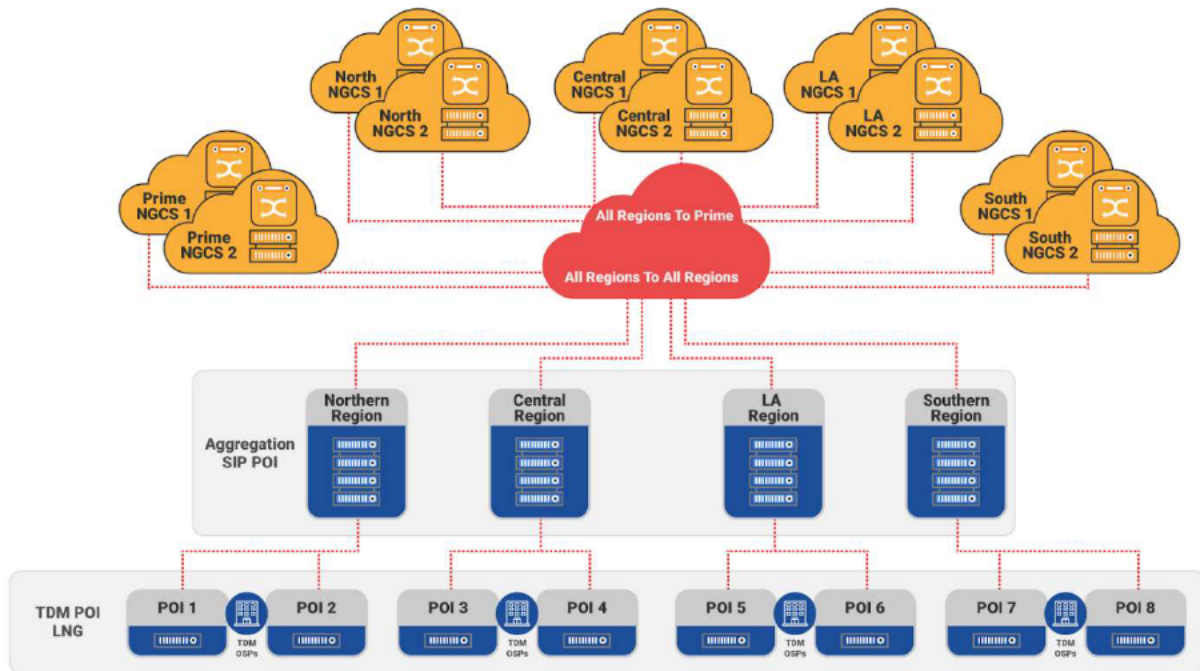

EXHIBIT 20: TECHNICAL REQUIREMENTS NARRATIVE RESPONSE
NGA 911, LLC

Exhibit 23: 23.0.12.1

List all subcontractors that will be used for aggregation. There is potential for some subcontractors to be used by multiple RNSP's or the PNSP. In that scenario, describe the bidder's strategy to prevent or mitigate one subcontractor's outage from causing an outage in multiple regions. Bidder shall describe how their solution provides an autonomous solution for aggregation.

RESPONSE:

There are two aspects of Aggregation - SS7/PRI and SIP. NGA 911 is using Inteliquent for POIs where legacy aggregation and conversion occurs, via an LNG signal conversion (through a Protocol Interworking Function - PIF) to SIP. The egress of SIP from the POI is then transported via a tariff NG Trunk to the tariff SIP Aggregation service. NGA 911 is deploying the SIP Aggregation service using [REDACTED]

SS7 Aggregation

It is possible that Inteliquent may be used by multiple RNSPs or even the PNSP: in fact, we know for certain they have partnered with other vendors for SS7 aggregation services. We mitigate this challenge and risk in two ways. First, facilities hosting the Regional SS7 Aggregation Service are in different geographic locations than the PNSP, other RNSPs, and NGCS Facilities to ensure no single point of failure exist within the California NG9-1-1 in its totality. This provides autonomy between the SS7 Aggregation Service and the NGCS. No single catastrophic event will take both an instance of SS7 Aggregation Services and an instance of NGCS out of service. Second, during the planning sessions with Cal OES, PNSP, and RNSP, should we discover that redundancy or resilience of SS7 Aggregation is compromised, then NGA 911 would install an alternative LNG product (several proven products are available) at the POI to handle this situation.

SIP Aggregation

We have no subcontractors for SIP Aggregation Service. SIP Aggregation is performed via an SBC Softswitch [REDACTED]. Each SIP Aggregation point for the region will be isolated and autonomous.

[REDACTED]

While the first step of SIP Aggregation is to facilitate the IP cutover where all 911 traffic ingresses from the POI, over the longer term, Wireless Carriers will terminate their SIP traffic at these SIP Aggregation Points. In fact, the deployment of RTT by the Wireless Carriers will facilitate the requirement for this deployment method. NGA 911 understands that having compatible technologies between the SIP Aggregation Point and the Wireless Carriers egress will mitigate the risk of this transition and facilitate adoption by both the state and carriers, thereby increasing the functionality of the 911 system in California and accelerating the path to the NENA i3 end state.

EXHIBIT 20: TECHNICAL REQUIREMENTS NARRATIVE RESPONSE

NGA 911, LLC

Exhibit 23: 23.0.13

Describe how the bidder will receive, maintain, and push the centralized policy routing instructions for the region.

Response:

NGA 911's Region will receive from, maintain and push back up to the Centralized Policy Store, maintained and operated by the Prime vendor, all current Policies in compliance with NENA specifications. This means the PRF checks the timestamps of the current Policies at the Regional and PSAP level and if out of date, query the Policy Store each time the ESRP must evaluate a 'next/last hop' result from the ECRF.

The California NGCS ESInet(s) benefit from an inherent hierarchical structure where Policies can be applied and enforced to provide efficient, effective, and logical routing based on the best current available NMS Information. Where Information includes but is not limited to OSP call volumes, RNSP(s) status, PSAP(s) status, network operational conditions, available location information (of individual calls at ingress), incidents (local, regional, statewide, and national), planned events, maintenance schedules and much more.

Receive Policy Routing Instructions. The key to efficiently managing and maintaining centralized policy routing rules is the use of the Policy Store. The Policy Store provides the centralized PRF and all subordinate PRFs with Policies depending on the information relevant to a specific Emergency Service Routing Proxy (ESRP) location in the ESInet and its operational domain (i.e., a Region I-ESRP's domain is Region I and a PSAP's ESRP/PRF domain is that PSAP). The PRF receives policies by querying the Policy Store through a web service or other means as established by Cal OES and the Prime. In the case that a Policy has expired, and for some reason has not received an update, the PRF will make the query the Centralized Policy Store, maintained by the Prime, before issuing a routing modification.

Centralized Policy Store. A central policy routing store is essential to realizing the expected redundancy in California. In addition to their primary routing responsibilities, the PNSP and RNSP are each expected to provide failover responsibilities for each other. So, the PNSP could failover to the RNSP and vice versa. Achieving such functionality in a vendor-diverse architecture requires a central Policy Routing Store that will allow for updating, storing, and retrieving policy routing instructions and ensuring that routing rules are the same between RNSP and PNSP. To achieve this essential requirement, the Prime will administer a statewide Centralized Policy Store and make it available to all Regions. The NGA 911 Regions will receive, maintain, and push their own policies to/from the Centralized Policy Store maintained and operated by the Prime. Interaction with the Policy Store will be via both web and API interfaces.

Maintain Policy Routing Instructions. All policies promulgated by the Policy Store have an expiration timestamp, and refresh automatically when they expire. To maintain redundancy, the Policy Store is replicated and distributed. There is a single authoritative master store the Centralized Policy Store that covers all Policies, and there may be one or more replicas of that policy in other distributed Policy Stores at the Prime and Regional level. At all times, the PRFs at the different layers of the ESInet will maintain 'default' routing rules, in the unlikely event that they lose access to the Policy Store Web Service but are still needing to route traffic (the reason this is an unlikely case is that a PRF losing contact with the Policy Store Web Service is an NGCS fault that should invoke bypassing of the NGCS in favor of a functioning NGCS at the Prime or Regional level).

Push Policy Routing Instructions. At the very least each PRF in the ESInet should run an Updated Policies request which will return a list of policies updated in the Policy Store since a given time. However, NGA 911 recommends that Cal OES implement a Push capability as a fundamental service of the Policy Store. Especially given the interdependencies of Prime, Region, Inter-Region, and PSAPs. The Push service will issue immediate PolicyUpdates and particularly to the affected Functional Elements in the event of both routine and emergency PRR changes.

The proposed hierarchy is depicted in **Diagram 23.0.13.1**. A Centralized Policy Store is the source for all "routing" policies in the ESInet. In some implementations, the PRR (Policy Routing Rules) are used only for modifications to the default routing rules for the 'diversion' of calls. NGA 911 proposes that PRR's be used as the primary way of routing traffic at all times covering, of course, every practical call diversion scenario but also ALL default routing in the ESInet (to include the Regional ESInets). The reason is twofold: to provide for consistent, centralized routing instructions throughout the ESInet and to provide for a universal ECRF/LVF, which is an option proposed by NGA 911.

Policy Store Hierarchy and Procedures

All ESRP/PRFs in the network are required to be completely current with any and all PRR's relevant to their domain. The domain for a PSAP is the PSAP itself which communicates its current policies via the Policy Store to the Regional domain via the PRF provided (see PSAP PRF below). Similarly, the Regional ESRP/PRF domain takes into account all of the current PSAPs and Regional Aggregation/Ingress (OriginationPolicy) policies and states and provides

EXHIBIT 20: TECHNICAL REQUIREMENTS NARRATIVE RESPONSE

NGA 911, LLC

them to the Policy Store. The Prime must also provide its statuses to the Policy Store as well since there are scenarios where 'diversions' could be required due to the non-availability (whether due to maintenance or incident) of parts or all the PNSP.

All current default, conditional, and temporary PRR's are in the redundant Policy Store. The Policy Store can query and audit the current state and load of each and every subordinate PRF in the network including the Prime. As a failsafe all PRF's should have the ability to provide the default PRR's even if they are not able to access the Policy Store (this is a conditional response, but in fact a failure of the PRF to update from the Policy Store will actually result in that ESRP - whether PSAP, Regional or Prime- to be bypassed and alternatively routed)

Regional Default Routing Schema (Diagram 23.0.13.2)

In the RNSP at call ingress, the originating ESRP will observe the PIDF-LO (for i3 or as presented by the LIF from the best available location/key at the time) and query the Regional copy of the universal ECRF which depending on the type of location data presented will evaluate it directly or send it to the LVF for verification before responding to the ESRP. The ECRF will then return a URI for the corresponding 'last hop' PSAP (depending on the presented URN there can be other 'last hop's in the ESInet). The ESRP checks with the PRF TerminationPolicy (which will be persistently loaded as the default unless a 'diversion' is active). The TerminationPolicy is aware of ALL potential 'last hop's' in the California ESInet(s) (and foreign ESInets – which of course the URI will be for the BCF/ESRP of other -non-California- ESInets). The PRF then returns the 'next hop' to the ESRP which if the call is destined to an active and available PSAP in the Region will be the 'last hop' address; or if the call is destined to a 'last hop' outside the Region, the 'next hop' will be the Prime ESRP (unless the Prime ESRP is not available and the TerminationPolicy will provide a different 'next hop' such as a backup Region ESRP).

RNSP Failure

In order for call routing to be impacted by an RNSP failure, the failure must be recognized as information from the NMS, and the response depends on the nature of the failure. However, for the sake of addressing PRR and a centralized approach, we assume a failure is recognized, and the Policy Store is updated accordingly. If the RNSP failure is after the Regional ESRP/PRF, then the Termination Policy immediately returns the Prime ESRP as the 'next hop' and the call will process accordingly. Another scenario is that the failure is at the ESRP and the Regional Aggregation Service is made aware of this as the Regional ESRP is non-responsive. In this case, the default ESRP is ALWAYS the Prime ESRP and the call is directed to the Prime and processed accordingly.

PSAP PRF (Diagram 23.0.13.3)

The NGA 911 PRF allows individual PSAPs to define Policy Routing Rules (PRR). The PRF can be configured to manage the operational time of various PSAPs based on time of day, days of the week, holidays and/or scheduled maintenance. The PRF can also handle variances in staffing, software or hardware malfunctions or any other event that could impact the capacity and availability of a given PSAP.

Access to the PSAP PRF occurs through a secure web-based portal which provides a menu-driven interface to effectuate the above time based, capacity, and redirect instructions for the servicing ESRP(s). The system also has mechanisms to disallow invalid rules. Rules submitted through the web interface are validated to prevent routing errors. NGA 911 will receive centralized policy routing instructions via the secure web-based portal. NGA 911 will verify with the associated jurisdiction that they consent to the PRR. Post PSAP written consent of acceptance of the PRR NGA 911 will establish the PRR. NGA 911 will maintain the PRR's via our secure web-based portal. NGA 911 exceeds this requirement by verifying pre-approved jurisdictional agreements for ad-hoc PRRs in the event of an emergency or event requiring the ad-hoc PRR.

PSAP Specific Routing: Training and practice of common scenarios will be provided to each PSAP before the formal release of the PSAP PRF. Based on our experience, we expect that the following will be common in the deployment of the PSAP PRF:

- 1) Local PSAP default routes. Most local PSAPs reroute to a neighboring PSAP in the Region. These default routes will be stored in the Centralized Policy Store; with any changes at the PSAP level being immediately 'pushed' to the Policy Store by the UpdatePolicy command.
- 2) If CHP throws the "Chicken Switch" it default routes to another CHP; It can go to a CHP in the same region but often will go to a CHP in a different region. This is an example of a Routing Rule that needs to be stored in the Policy Store.
- 3) If an x,y is missing where does CalOES want to route it? Today those default route to CHP, but Cal OES can use the Centralized Policy Store to modify the serving PSAP for such calls at any time.

EXHIBIT 20: TECHNICAL REQUIREMENTS NARRATIVE RESPONSE NGA 911, LLC

Diagram 23.0.13.1 NGA 911 proposes an option for the Centralized Policy Store that provides and enforces the PRRs through the PRF's in a hierarchy where the lowest domain is GREEN (PSAP), YELLOW (Regional), RED (Prime), and BLUE (authoritative). The adoption of this method permits the deployment of a universal ECRF/LVF in ORANGE. A universal ECRF/LVF, hosted by NGA 911 at the Regional Level always provides the same URI ('last hop') for a given QUERY where the PRF processes that URI to provide the CONDITIONAL 'next hop.'

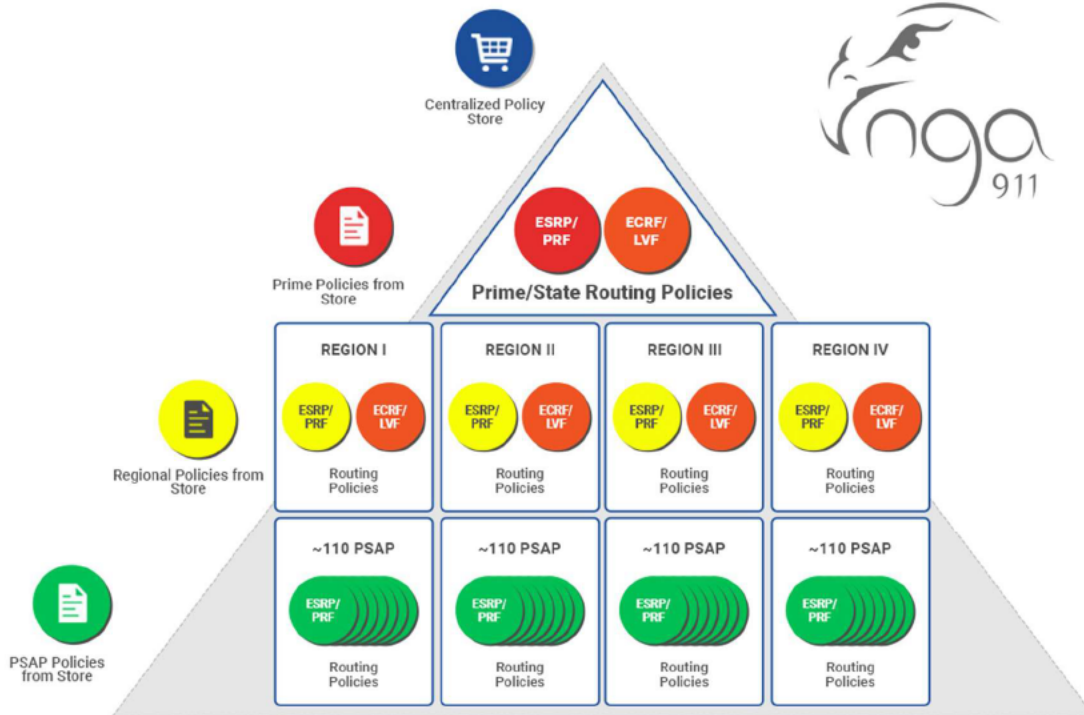
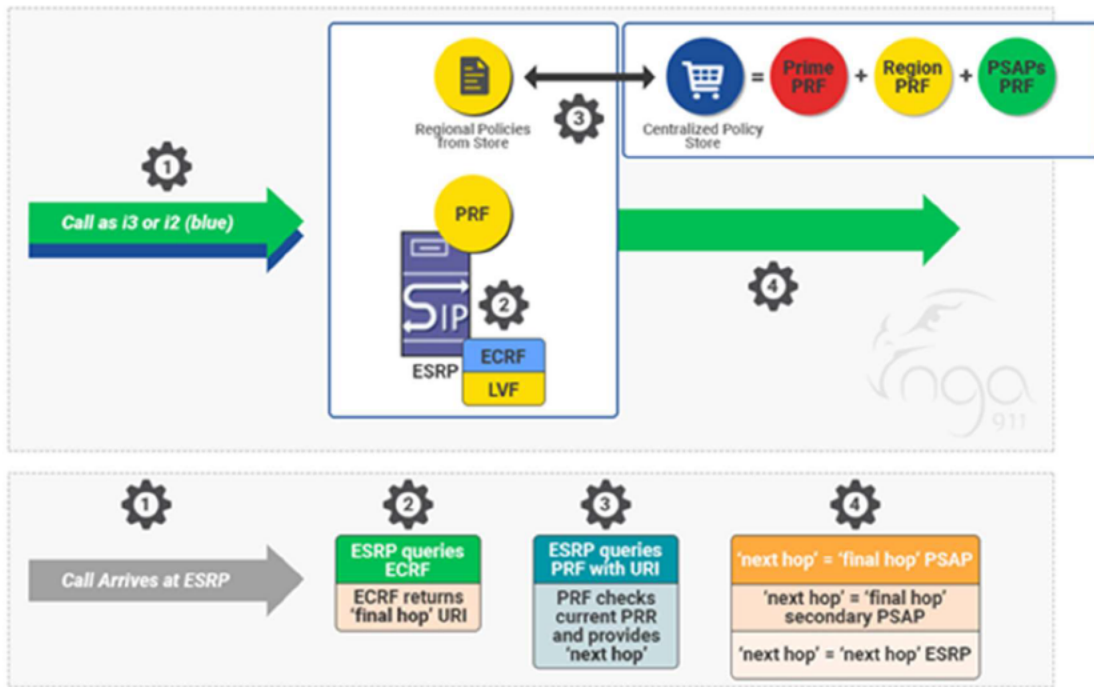

EXHIBIT 20: TECHNICAL REQUIREMENTS NARRATIVE RESPONSE NGA 911, LLC

Diagram 23.0.13.2 ESInet Call Handling in the Core(s) with Centralized PRR Method



Copyright © 2019 All Rights Reserved NGA911

NGA 911 proposes a top-down Centralized PRR method for managing call flows in the ESInet.

1. After a call is pre-processed through any number of Aggregation Services, it arrives through the BCF at Serving ESRP for an NSP ESInet.
2. The ESRP takes the available information from the SIP Header (the Header Information will be dependent on call type: i3, i2, E911, Legacy – TN) and sends the URN and location information to the ECRF (no matter the type presented the ECRF/LVF with support from the LDB, if needed, can process it). In the Centralized PRR method proposed by NGA 911, the ECRF returns the 'final hop' URI.
3. The ESRP presents the 'final hop' URI to the PRF which checks it against the current TerminationPolicy and provides the ESRP with it's ACTUAL 'next hop.'
4. Generally the 'next hop' will be one of three types: most often a 'final hop' to the serving PSAP in the domain (Region or Prime) of the ESRP, a 'final hop' to a secondary PSAP handling the serving PSAPs call or calls due to settings in the serving PSAP's PRF, or the 'next hop' is actually a 'next hop' to another ESRP most likely in another domain.

EXHIBIT 20: TECHNICAL REQUIREMENTS NARRATIVE RESPONSE NGA 911, LLC

Diagram 23.0.13.3: Rules Setting User Interface for implementation in the PRF and PRR with example of the Time of Day interface

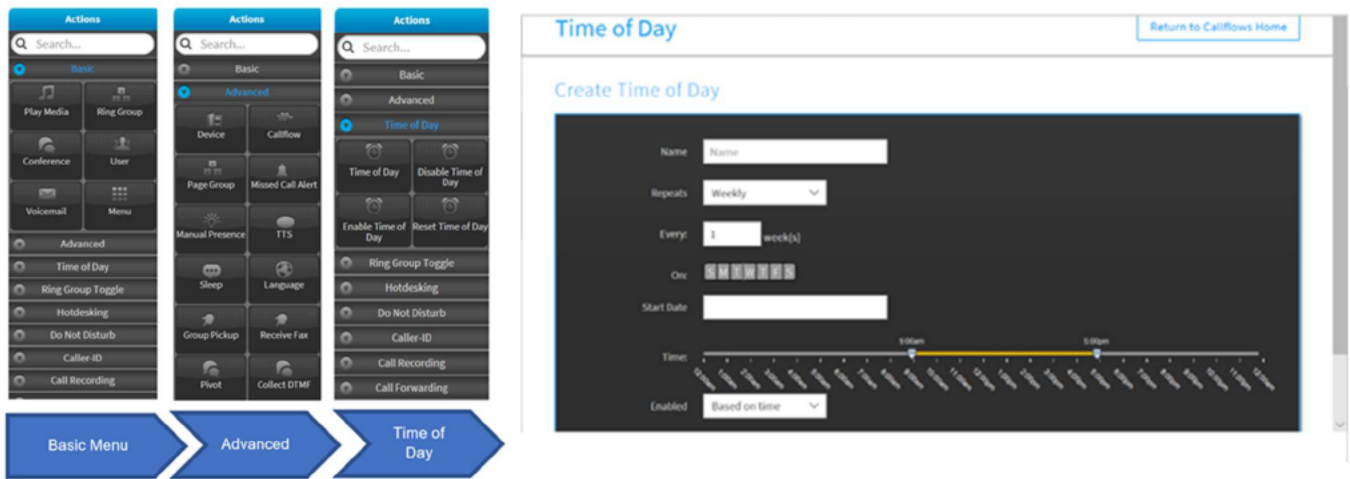

EXHIBIT 20: TECHNICAL REQUIREMENTS NARRATIVE RESPONSE
NGA 911, LLC

Exhibit 23: 23.0.14

Describe the security and firewalls needed to protect NG9-1-1 Services in accordance with NENA NG-SEC 75-001. The solution must be able to detect, mitigate and report TDOS, DDOS and any other Cyber-attacks.

Response:

The overall security of the network is dependent on mutually developed best practices as established by the collaborative work of the RNSP, Cal OES, and PNSP; as well as routine audits by independent third-party cybersecurity experts that validate security for all NG9-1-1 Services. Constant monitoring and application of security updates from NENA, NIST, CVE, DHS-CISA, and others are also essential. Furthermore, operationally, adherence to protocols established by the Certificate Authority “CA” should mitigate the risks of an insider breach. Technologically, our defense not only detects, mitigates, and reports on TDOS and DDOS attacks but also includes a defense in depth approach that covers all aspects of security including but not limited to ICAM, Physical, Session, OS, Certificates, etc.

NGA’s Security Policy Note: NGA 911 maintains a living security document known as the Security Policy Note (SPN) which is the basis of our defense to protect all layers of the IP protocol stack. The SPN takes into account and complies with the NENA NG-SEC 75-001 Audit Checklist (Diagram 23.0.14.1). We understand that cybersecurity is a continually changing and ongoing process that includes but also goes beyond only security and firewalls. NGA 911 leverages the vast body of activities and knowledge dedicated and committed to Cybersecurity to ensure a constant refresh of cybersecurity policies. The National Institute of Standards (NIST) is a primary go-to organization for this information and a leader in combating cyberthreats. On April 25, 2019, NIST released the “NIST Roadmap for Improving Critical Infrastructure Cybersecurity Version 1.1” which covers new areas including Cyber-Attack Lifecycle, Internet of Things, Measuring Cybersecurity, Referencing Techniques, and Secure Software Development.

As recommended (but not detailed by NG SEC) we define in our internal Security Policy Note (SPN) severity categories as a best practice for categorizing and prioritizing responses (see Diagram 23.0.14.8)

The latest version of the operational SPN is SPN_NGA 911 Security Framework Overview v_e_2019. A CONFIDENTIAL copy of the SPN will be shared and discussed with Cal OES. The intention of NGA 911, consistent with our QMS, is to align the SPN Security Framework to the ‘living’ requirements of Cal OES Information Security Policies, CAL SEIC, the State Threat Assessment Center, and the State Chief Information Officer.

Firewalls and BCF/SBC Interfaces

NGA 911 implements different BCF firewall profiles based on where the interface resides in the ESInet and/or the Service Interface (i.e., PSAP vs. external MIS access) to protect the NG9-1-1 services per NENA NG-SEC 75-001 and NENA i3 standards. Below is a description of the firewalls used based on where the interface resides:

Regional NGCS to PSAP BCF Interface (Diagram 23.0.14.2)

Physical Layer – makes up all the ‘wires’ coming into the facility and being aggregated, bonded, and connected through Dx (Direct Connect) to the Cloud. All of which are monitored for SLA and performance, which can be an indicator of anomalous behavior that could be the result of a security breach.



CPE – where the user and the agent (terminal) must be authenticated, authorized, and granted permissions based on service profiles (roles), applications, and the current state of the PRR from the Policy Store.



Regional NGCS, SIP Aggregation and POI Services (Diagram 23.0.14.3)

For Aggregation and POI Services provided by NGA 911 (all wireless, AT&T wireline, Consolidated Communications wireline, and Frontier wireline OSPs), the interfaces and protections are similar to the PSAP where we have a unified and NGA 911 provided BCF on both ends. The only exceptions are Physical (CAPSNET is not included although if Cal OES wishes it can be), and OSP – the agent profiles are consistent with a known group of ingress OSPs that are arriving on

EXHIBIT 20: TECHNICAL REQUIREMENTS NARRATIVE RESPONSE

NGA 911, LLC

preplanned, defined, and known trunks. Origination Policy defines Ingress Policy (at the ingress ESRP/PRF in the receiving NGCS, which in this case is the Regional NGCS).

Regional Aggregation Services to Prime NGCS (Diagram 23.0.14.4)

When the Regions provide Aggregation Services, the Physical connection is an NG9-1-1 Tariff Trunk that is supplied by NGA 911 and is bonded and aggregated by our SD-WAN.

RNSP to PNSP ESInets (Diagram 23.0.14.5)

This BCF to BCF interface is almost identical to Regional Aggregation Services defined above except for the fact that traffic is more likely to be directed from one California ESInet (RNSP and PNSPs) to the other based on Termination Policy from the Centralized Policy Store.

Internal Access to OSS, Policy Store (PRR) MIS and Reports (Diagram 23.0.14.6)

Certain Operational Support and Policy System Interfaces MUST be held within a NG9-1-1 system. For example, except for the tool used to create the PRRs and provision them in the system, there is no external interface to them. The Policy Routing Rules created and then disseminated by the Centralized Policy Store are strictly classified as sensitive (restricted) as defined in NG-Sec. Other OSS's are tightly regulated on a per-service basis, accessible by SPECIFIC physical hardware with the proper ICAM credentials. For all these Internal cases, FULL BCF to BCF interfaces are enforced.

External Access to MIS and Reports (Diagram 23.0.14.7)

Limited external access to the MIS, the NMS, monitoring and reports can be handled by proxies that may grant access to properly credentialed individuals with multi-factor authentication. The proxies themselves will be monitored and limited in their interactions with the NGCS. Such limits include read-only, profile specific authorizations, and access (volume).

Monitoring, Detecting and Mitigating DDOS, TDOS and other Attacks

The NGA 911 Security Operations Center (SOC) monitors the authorized use of the network including DDOS, TDOS, and other attacks. Should identification of a vulnerability or a threat occur, we perform the initial and emergency response to the security event and in less than 24 hours provide the CA 9-1-1 Branch a document describing the measures taken, and any additional implementation plans to avoid a breach entirely.

NGA 911 protects against unauthorized individuals accessing the network by enforcing strict ICAM procedures. NGA 911 applies predictive analysis and modeling to detect, mitigate, and combat security threats. Monitoring of the NGA 911 network occurs via an Intrusion Prevention System (IPS) within the BCF to detect and prevent any network threats from entering the NGCS. Integration of the IPS with the BCF provides the ability to apply IPS signatures to Internet Protocol (IP) packets within the GPRS Tunneling Protocol (GTP), User (GTP-U) plane tunnels, and GTP Control plane (GTP-C) tunnels. The IPS will intercept packets and inspect traffic for various threats (such as signaling storms). This allows for an automatic pass/drop packet decision, plus enables the (SOC) to monitor and log any malicious events. The IPS also uses unique traffic-learning algorithms to effectively detect network anomalies and block traffic outside of configured thresholds. In addition, management of intrusion prevention occurs via AI that quickly identifies, monitors, and reports anomalies that might be the result of a day-zero attack. AI is proving itself as one of the best and most effective protections against attacks. AI immediately identifies anomalies and suggests to the SOC mitigation and largest attack capability. This effectively stops Distributed Denial of Service (DDOS), Telephony Denial of Service (TDOS) attacks and other threats characterized by anomalous traffic patterns. There is also built-in signaling support for Session Initiation Protocol (SIP) to protect voice, text, and media infrastructure and RTP traffic (i.e. SRTP). It is of critical importance that the ingress Network, ESInet, NGCS, and PSAPs are isolated to minimize and obscure attack vectors. Primarily as a primary defense against DDoS and TDoS.

Upon detection, the SOC and operations are secured by Network Segregation techniques in an active-active network where media is sent across to distinct paths. A disruption of one is not necessarily impacting the other. The IPS, AI, and network monitoring isolate the source of the DDOS and TDOS threat and segment the traffic immediately. In almost all cases the source of such attacks is through the ingress network and the source OSP will be identified and notified. The FE's in the affected core are isolated and if possible, traffic from that OSP is handled. If necessary, the offending OSP's traffic will be blocked until working together with the OSP, the NOC, SOC, and Cal OES the threat is eliminated and the OSP is allowed back on the network.

EXHIBIT 20: TECHNICAL REQUIREMENTS NARRATIVE RESPONSE
NGA 911, LLC

Diagram 23.0.14.1 Defense in Depth Approach as defined in SPN

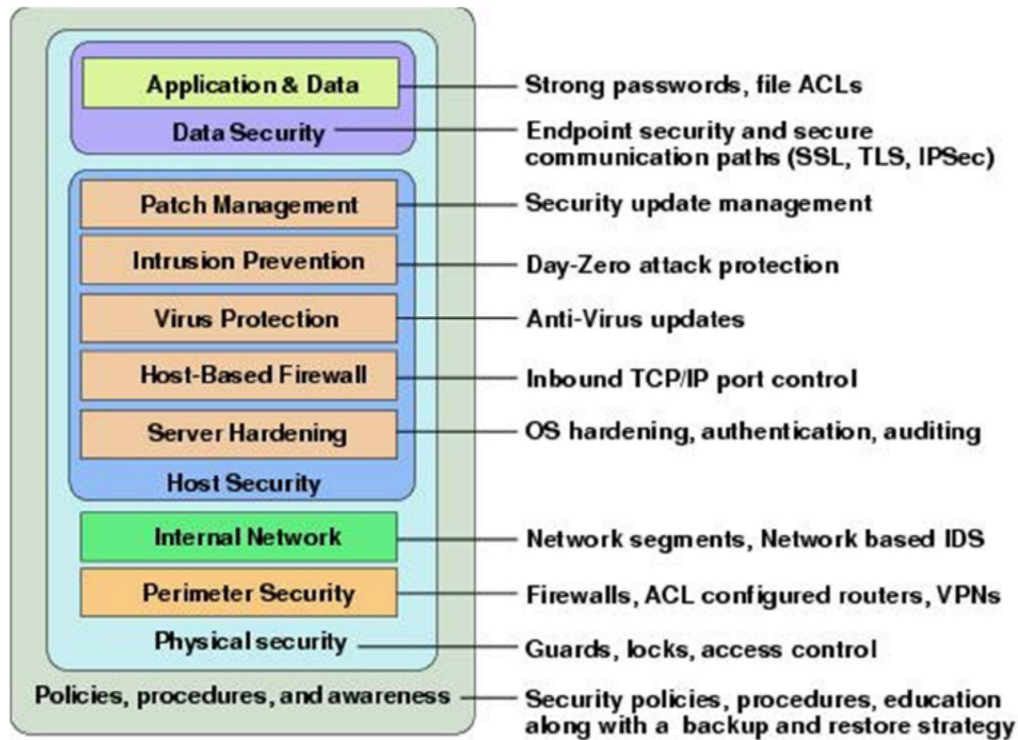

EXHIBIT 20: TECHNICAL REQUIREMENTS NARRATIVE RESPONSE
NGA 911, LLC

Diagram 23.0.14.2 Prime NGCS to PSAP BCF Interface



EXHIBIT 20: TECHNICAL REQUIREMENTS NARRATIVE RESPONSE
NGA 911, LLC

Diagram 23.0.14.3 Region NGCS to NGA 911 provided Aggregation Services

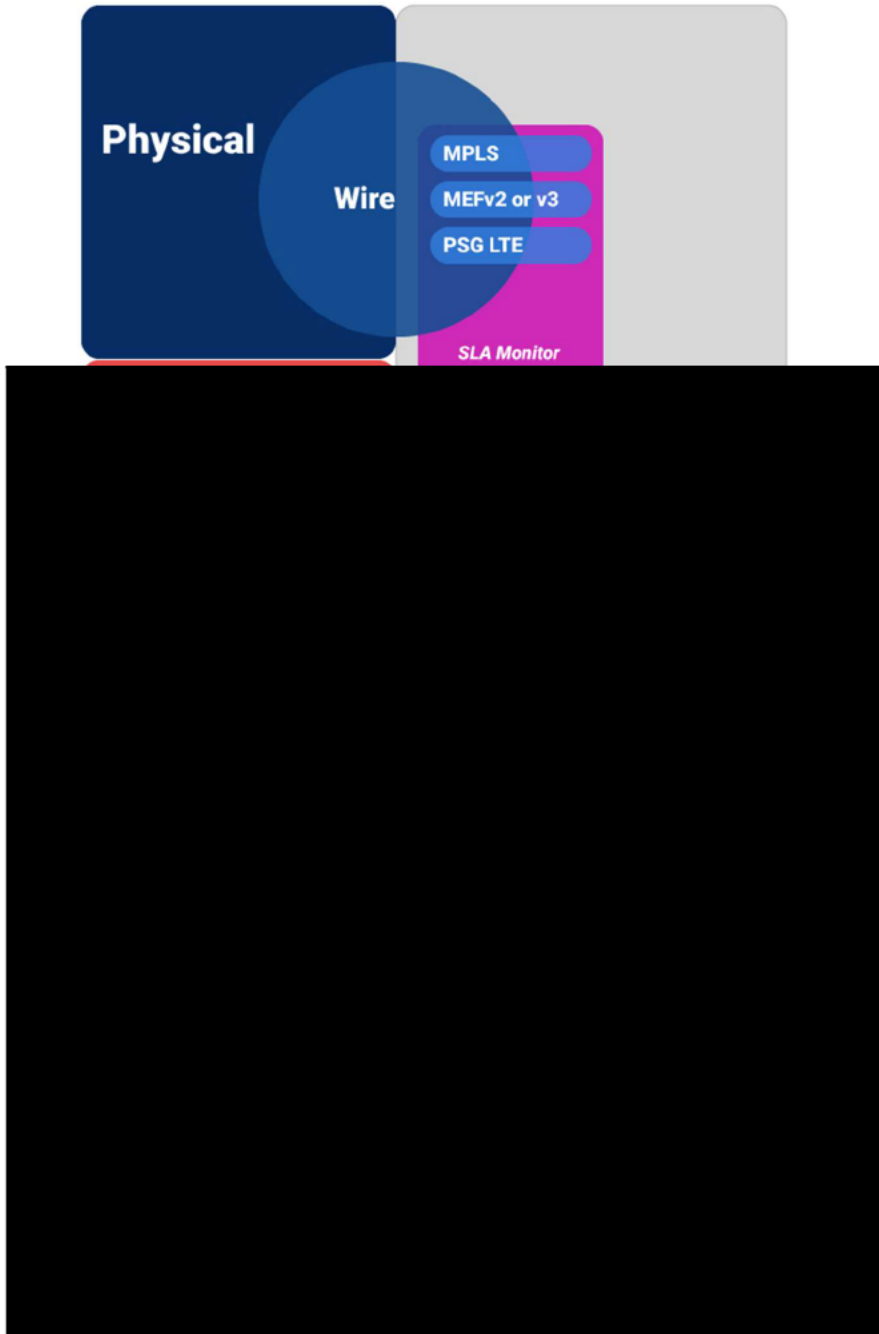

EXHIBIT 20: TECHNICAL REQUIREMENTS NARRATIVE RESPONSE
NGA 911, LLC

Diagram 23.0.14.4 Region NGCS to Prime Aggregation Services



EXHIBIT 20: TECHNICAL REQUIREMENTS NARRATIVE RESPONSE
NGA 911, LLC

Diagram 23.0.14.5 RNSP to PNSP ESInets



EXHIBIT 20: TECHNICAL REQUIREMENTS NARRATIVE RESPONSE
NGA 911, LLC

Diagram 23.0.14.6 Internal Access to OSS, Policy Store (PRR) MIS and Reports



EXHIBIT 20: TECHNICAL REQUIREMENTS NARRATIVE RESPONSE
NGA 911, LLC

Diagram 23.0.14.7 External Access to MIS and Reports



EXHIBIT 20: TECHNICAL REQUIREMENTS NARRATIVE RESPONSE
NGA 911, LLC

Diagram 23.0.14.8 NGA 911 Security Policy Note (SPN) severity categories (e.g. high, Medium, or Low)

<p>High – direct threats on the functioning of any major component, function, and performance of the network, especially as it relates to the delivery of calls (and the identification and mitigation of DDOS and TDOS attacks).</p>
<p>Medium – threats to data, personal identified information, access (that are judged not to impact current operations), and low-level network functionality. Password enforcement, security update management, day-zero and antivirus mitigation, endpoint security (TLS, Certs, SRTP, and IPSec), BCF/SBC management.</p>
<p>Low (but by no means unimportant) – Security policies, procedures, education, backup and restore strategies, table top exercises, and ongoing audits.</p>

EXHIBIT 20: TECHNICAL REQUIREMENTS NARRATIVE RESPONSE NGA 911, LLC

Exhibit 23: 23.0.15

Provide a diagram(s) that shows 9-1-1 traffic flow architecture from ingress to egress using a non-proprietary NENA i3 compliant solution with dedicated NG Core Services for California.

Response:

The following diagrams show all the ingress to egress flows that can be supported on NGA 911's non-proprietary NENA i3 compliant ESInet **comprised of a multi-layered redundant systems, software and facilities with no single point of failure** and dedicated to California.

Building Blocks Each key component and service is depicted as a building block which collectively provide for all the various call flows in a redundant manner. The main building block are depicted in Diagram 23.0.15(a through e):

(a) TDM POI, (Tariff Section - Aggregation Services) handles all legacy ingress types (TN, E911, ESWG, etc) and uses an LNG to convert to SIP where the session will be anchored. At this stage LNG only performs the Protocol Interworking Function (PIF);

(b) NG Trunks, NG Trunks (Tariff - NG9-1-1 Trunk Services) – NG9-1-1 Trunks are deployed throughout the network as required. When deployed they are bonded and aggregated by an SDWAN Layer 3+ overlay which provides link level and end-to-end Network Monitoring;

(c) SIP Aggregation, (Tariff Section - Aggregation Services) is the ingress for all native and converted SIP traffic. i3 traffic is anchored at the BCF and forwarded to the NGCS (BCF to BCF - ESRP). Converted SIP (from (a) TDM POI) is processed with the Location Interworking Function (LIF) supported by LDB and MPC/VPC interfaces to produce an i3 SIP Header (Network Interworking Function – NIF) with PIDF-LO either by reference or value depending on Cal OES / Prime Standards;

(d) NGCS (R-Region and P-Prime), Core Services (Tariff - NG Core Services) - the i3 SIP INVITE from (c) – SIP Aggregation) enters the NGCS BCF and is processed by the ESRP for 'next hop' routing based on the URI provided by ECRF (which is supported by LVF and LDB for civic or pANI routing) and the PRF's application of timely Policy Store PRR's. The ECRF, LVF, and LDB are assumed to be current with statewide GIS database in accordance with Cal OES and Prime policies (see 23.0.6). At this point calls will be directed to the in Region PSAP or through the Prime NGCS (P-NGCS) if the PSAP is out of Region or in Region but not reachable by the R-NGCS (see 23.0.2) interface; and

(e) PSAP, (Tariff - Region Functions and Services and NG Trunks Tariff) is connected directly to the Prime and Regional NGCSs by independently supplied, operated, and maintained PSAP Integration and NG Trunk Services. The PSAP PRF maintains current status with Regional PRF which in turn maintains and pushes/pulls PRRs from Prime Centralized Policy Store. An LPG is supplied as needed.

Diagram 23.0.15.1 is a depiction of NGA 911's complete range of support for every potential 9-1-1 traffic flow from ingress to egress. The available functional elements and services are arranged to accommodate the actual ingress (OSP type and technology), core (location routing), and PSAP (CPE type and capabilities) requirements.

OSP Ingress Facilities OSP ingress is dependent on the type of OSP, and the method of call signaling, and media delivered to the POI's. The RNSP has specific responsibilities to "groom" and deliver SIP i3 compliant 'calls' to the aggregation points:

1. NGA 911 will provide Points of Interconnect (POI)s and Legacy Network Gateway (LNG) services (as needed) to the major Local Exchange Carriers (LECs) - AT&T, Frontier, and Consolidated Communications - up until such time that the LECs have made a conversion of their Plain Old Telephone (POT)s landlines to SIP. (Diagram 23.0.15.2)
2. NGA 911 will provide direct NENA i3 compliant ingress services (or E911 ingress, if necessary) to all Wireless OSPs in the Region. (Diagram 23.0.15.3)

Aggregation to RNSP to PSAP

Diagram 23.0.15.4 depicts a linear path for calls from ingress to egress within the Region. Although shown as a single line, the services and facilities are provided in a redundant manner with a minimum of two meshed POI's, SIP Aggregation, and NG Trunks between them. The NGCS is served by two independent Dx (Direct Connect) services

EXHIBIT 20: TECHNICAL REQUIREMENTS NARRATIVE RESPONSE NGA 911, LLC

to the 8 NGCS containers in the Cloud. PSAPs are connected redundantly to the NGCS both at the Region and Prime layers.

23.0.15.4(1) - For Legacy Providers Ingress from AT&T, Frontier, and Consolidated and E911 wireless carriers will begin at the TDM POIs which using an LNG will convert and anchor the media for calls delivered to the SIP Aggregation Points – 23.0.15.4(2). For OSPs arriving directly native i3, SIP ingress technically begins at the SIP Aggregation Points – 23.0.15.4(2).

23.0.15.4(3) - NGA 911's end-to-end private hosted SD-WAN approach **assures path diversity with both physical and carrier diversity** and the highest level of performance possible across the network. At the ingress aggregation points, NGA 911 uses **a private hosted SD-WAN Controller/Appliance that interoperates with the PNSP accessible over private network, including secure connectivity, trust and identity, threat defense from PSAP to OSP / SaaS applications, and an architecture that supports open security standards such as IPsec etc.** The benefits ensure that MOS scores are 'constantly' monitored, which exceeds the hourly (and 5 minutes in case of troubleshooting) requirements. We accomplish this through a unique machine-driven method whereby we evaluate the call quality at ingress and validate it against the machine evaluated received call quality at egress. This method makes use of anonymized measurements to provide a quality assessment of end-to-end media fidelity – see all (3's) for redundant links throughout the network. NGA 911 provides High Availability (H/A) NG Trunks (**supporting a minimum of 10 Mbps**) to all Endpoints (**PSAPs, Aggregation Points, PNSP, Direct Connect Facilities, and all other interfaces**). NG Trunks seamlessly aggregate diverse IP based interconnections (WANs) into a single integrated connection to **transport NG9-1-1 traffic and other 9-1-1 related traffic included but not limited to NG9-1-1 Alert and Warning, as directed by CA 9-1-1 Branch**. The NGA 911 Bonded NG Trunks handles BGP (Layer 2 or Layer 3) at each PSAP. Bonded NG Trunks are transport independent and centrally managed from our Network Operations Centers (NOCs). Our NG Trunks are configured to offer segmentation of traffic for 9-1-1 **call isolation by stream or channel** to enable the tracking of 9-1-1 traffic from ingress at the OSP to egress at the PSAP or to the PNSP. Our NG Trunks can be configured **to offer a shared VPN schema across any WAN circuit (i.e., LTE, MPLS, broadband, etc.) and supports flexible VPN extension to all endpoints (IaaS, PSAP branch, aggregation points, data centers, gateways)** with a supporting NG Trunk Controller/Appliance.

23.0.15.4(5) Calls through the Region are routed directly to the PSAPs in the Region. Refer to 23.0.2 For call flows to a PSAP not in Region.

23.0.15.5(media) - Media call flows are optimized and exceed those possible from any single network provider utilizing a unique feature and configuration of our SD-WAN. Media for each call flow is sent over multiple paths simultaneously which are individually assessed in a comparator upon reaching the PSAP destination and on the return path back to the OSP demarc.

Monitoring and Reporting of End-to-End Call Flows - Under normal conditions, OSP traffic within the NGA 911 Region is aggregated by the NGA 911 (AT&T, Consolidated Communications and Frontier wireline, and all wireless OSPs) and delivered end-to-end to the PSAPs within the Region. In this case, NGA 911 as an RNSP will feed SLA, trouble ticketing, and performance monitoring data to both Cal OES and the Prime.

Aggregation to RNSP with Transfer to another Region through PNSP to PSAP (Diagram 23.0.11.6)

Calls transferred from a PSAP to another Region must be directed through the PNSP Emergency Services Routing Proxy (ESRP) for call processing and delivery. In almost all cases the OSP ingress will be anchored at the Regional Aggregation Point where all call pre-processing will have been conducted as required including conversion to SIP i3, transcoding, and initial routing. SIP signaling for a transfer takes a route back from the transferring PSAP to the RNSP NGCS ESRP for forwarding to the PNSP NGCS ESRP to INVITE and then REFER the call to the new transferee PSAP. At this point, media flows can be optimized so that media flows from the anchor Aggregation Point to the destination PSAP will traverse the PNSP redundantly interconnected network to the PSAP endpoint.

EXHIBIT 20: TECHNICAL REQUIREMENTS NARRATIVE RESPONSE
NGA 911, LLC

Diagram 23.0.15

a. TDM POI (Tariff Section - Aggregation Services) with Legacy Inputs and LNG conversion to SIP (PIF only as this stage)

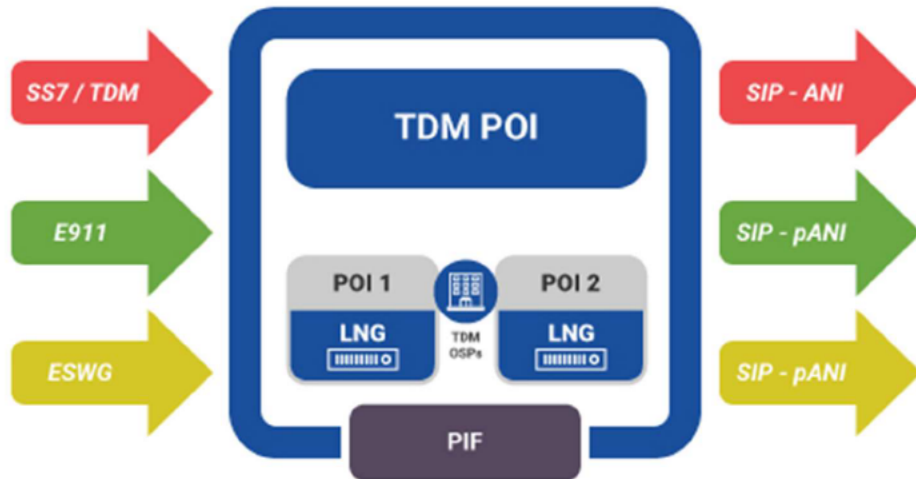

EXHIBIT 20: TECHNICAL REQUIREMENTS NARRATIVE RESPONSE
NGA 911, LLC

(b) NG Trunks (Tariff - NG9-1-1 Trunk Services) - Deployed throughout the Network with SDWAN Layer 3+ overlay and Network Monitoring

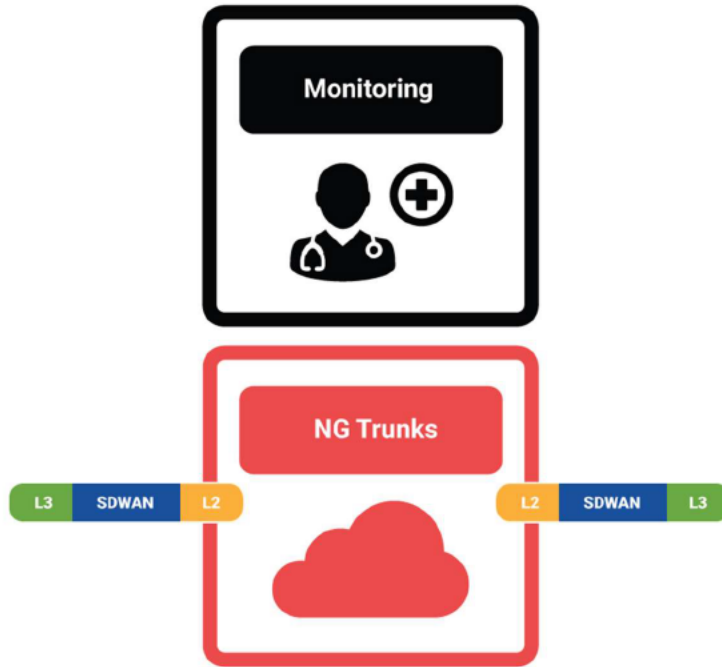

EXHIBIT 20: TECHNICAL REQUIREMENTS NARRATIVE RESPONSE
NGA 911, LLC

(c) SIP Aggregation (Tariff Section - Aggregation Services) Ingress of all native and converted SIP traffic. i3 traffic is anchored at the BCF and forwarded to the NGCS (BCF to BCF - ESRP). Converted SIP is processed with NIF and LIF (supported by LDB and MPC/VPC) to produce i3 SIP Header with PIDF-LO.

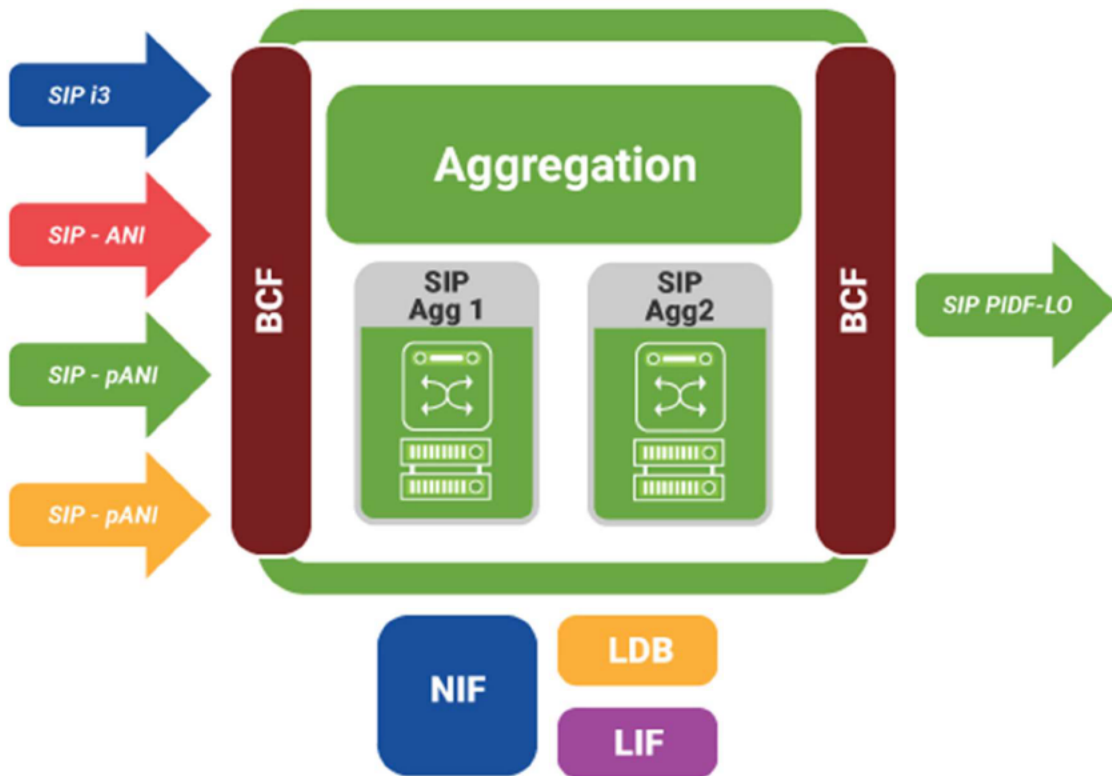

EXHIBIT 20: TECHNICAL REQUIREMENTS NARRATIVE RESPONSE NGA 911, LLC

(d) Core Services (Tariff - NG Core Services) - i3 SIP INVITE enters the NGCS BCF and is processed by the ESRP for 'next hop' routing based on URI provided by ECRF (which is supported by LVF and LDB for civic or pANI routing) and PRF's application of timely Policy Store PRR's. ECRF, LVF, and LDB are current with statewide GIS database in accordance with Cal OES and Prime policies. At this point calls may also be directed through the Prime NGCS (P-NGCS) as required and necessary via the Regional-Prime BCF to BCF interface.

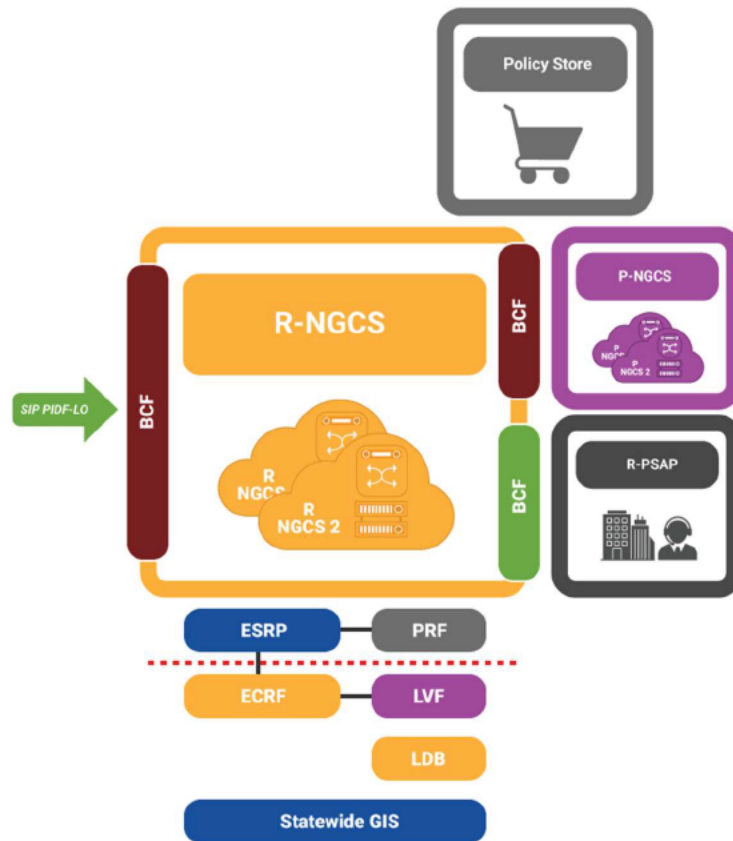

EXHIBIT 20: TECHNICAL REQUIREMENTS NARRATIVE RESPONSE NGA 911, LLC

(e) PSAP (Tariff - Region Functions and Services and NG Trunks Tariff) is connected directly to the Prime and Regional NGCSs by independently supplied, operated, and maintained PSAP Integration and NG Trunk Services. PRF maintains current status with Regional PRF which in turn maintains and pushes/pulls PRRs from Prime Centralized Policy Store. LPG is supplied as needed.

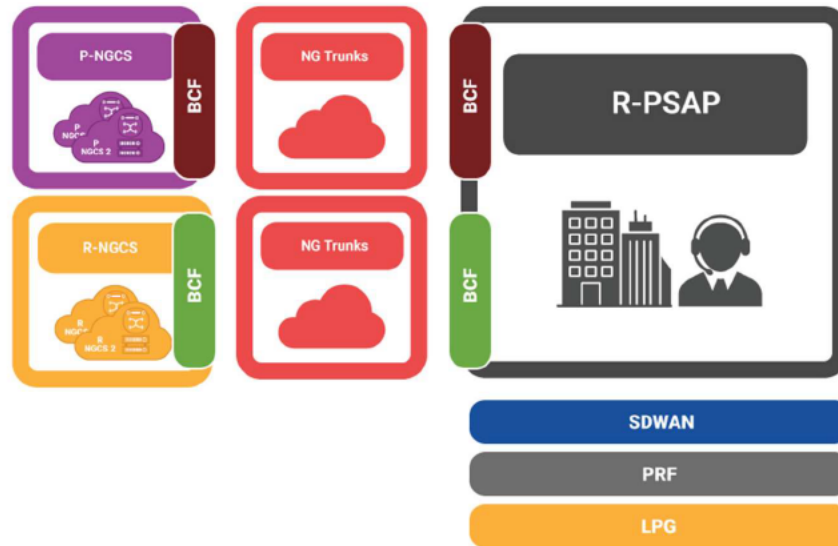

EXHIBIT 20: TECHNICAL REQUIREMENTS NARRATIVE RESPONSE NGA 911, LLC

Diagram 23.0.15.1: NGA 911 NENA i3 Architecture Supports All Possible Call Flows

OSP	Method	Location	Server	Out	Adapt	CPE Type
Wireless	E911	MPC	LDB	i3	LPG	CPE - ALI
	E911	MPC	LIS	i3		CPE - SIP
	E911	MPC	LIS	i3		CPE - i3
	NG-Tran	NG-Tran	LDB	i3	LPG	CPE - ALI
	NG-Tran	NG-Tran	LIS	i3		CPE - SIP
	NG-Tran	NG-Tran	LIS	i3		CPE - i3
	i3		LDB	i3	LPG	CPE - ALI
	i3		LIS	i3		CPE - SIP
	i3		LIS	i3		CPE - i3
Wireline (incl LEC using SIP)	SS7 / PRI	LNG	LDB	i3	LPG	CPE - ALI
	SS7 / PRI	LNG	LIS	i3		CPE - SIP
	SS7 / PRI	LNG	LIS	i3		CPE - i3
	i2	VPC	LDB	i3	LPG	CPE - ALI
	i2	VPC	LIS	i3		CPE - SIP
	i2	VPC	LIS	i3		CPE - i3
	i3		LDB	i3	LPG	CPE - ALI
	i3		LIS	i3		CPE - SIP
	i3		LIS	i3		CPE - i3
VOIP	i2	VPC	LDB	i3	LPG	CPE - ALI
	i2	VPC	LIS	i3		CPE - SIP
	i2	VPC	LIS	i3		CPE - i3
	i3		LDB	i3	LPG	CPE - ALI
	i3		LIS	i3		CPE - SIP
	i3		LIS	i3		CPE - i3

EXHIBIT 20: TECHNICAL REQUIREMENTS NARRATIVE RESPONSE
NGA 911, LLC

Diagram 23.0.15.2 California major ILECs at Ingress

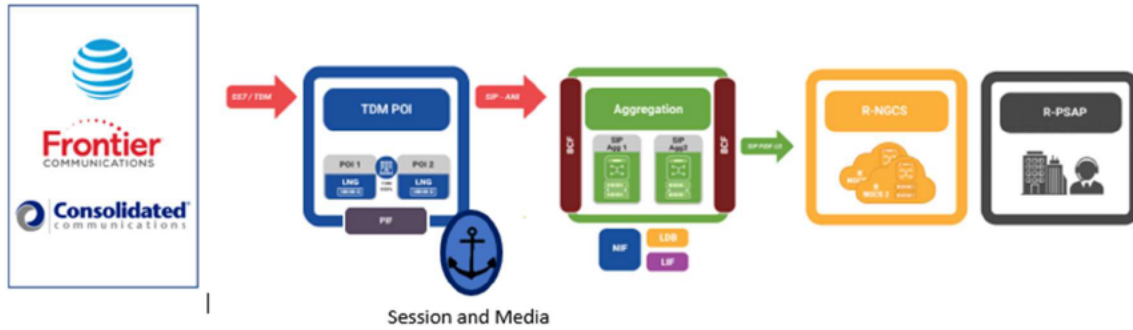

Diagram 23.0.15.3 Wireless Carrier at Ingress (a) legacy E911 and (b) i3

(a)

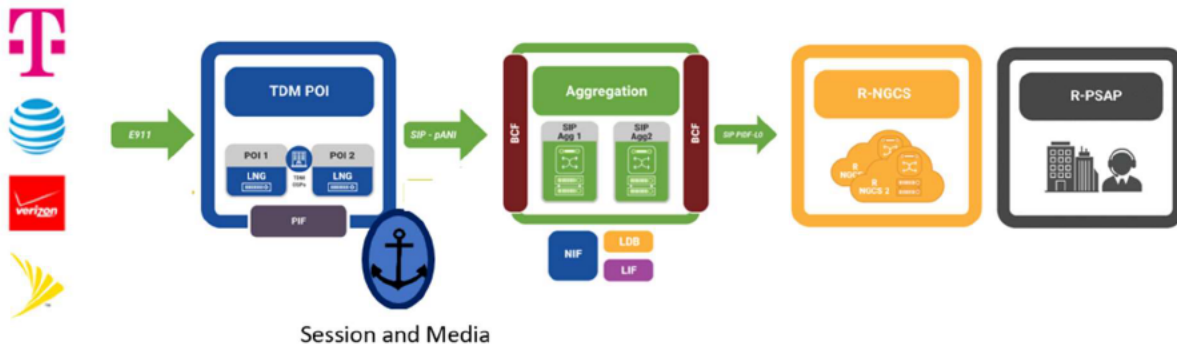

EXHIBIT 20: TECHNICAL REQUIREMENTS NARRATIVE RESPONSE
NGA 911, LLC

(b)

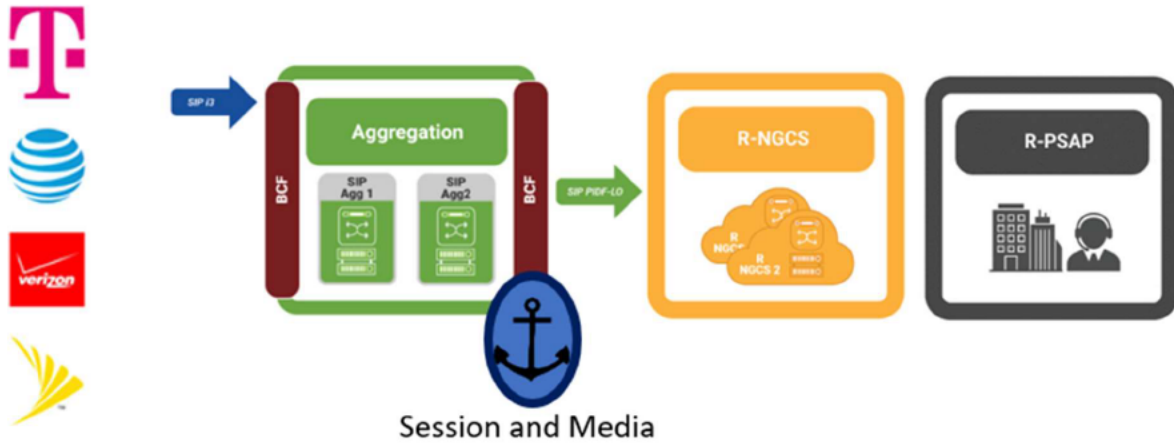

Diagram 23.0.15.4: NGA 911 Proposed 9-1-1 Regional traffic flow architecture from ingress to egress based on NENA i3



Diagram 23.0.15.5(media). Media Anchoring and Optimization - Media sessions are anchored at the SIP POI and/or SIP Aggregation Point (BCF) where at least two separate streams are delivered by alternative routes to the PSAP for comparison and selection of the highest fidelity packets at the CPE demarc.



EXHIBIT 20: TECHNICAL REQUIREMENTS NARRATIVE RESPONSE NGA 911, LLC

Diagram 23.0.15.6 Transfer call to other Region (a) is received at PSAP 1 and anchored at POI or Aggregation depending on origin (legacy or i3). (b) call is transferred to PSAP 2 in another Region via PNSP, and (c) PSAP 1 leaves the call and PSAP 2 takes the call but session media anchor remains at Regional POI or Aggregation.

(a)

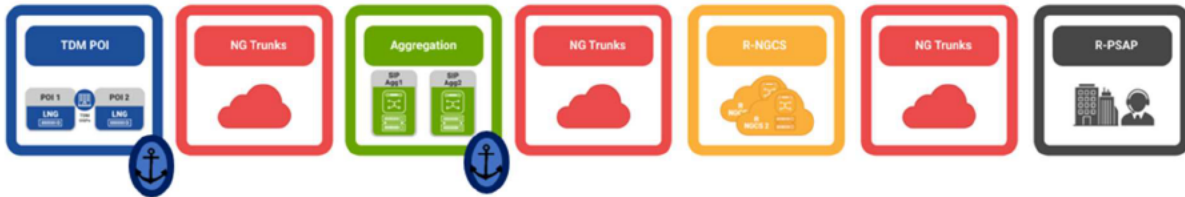

(b)



(c)

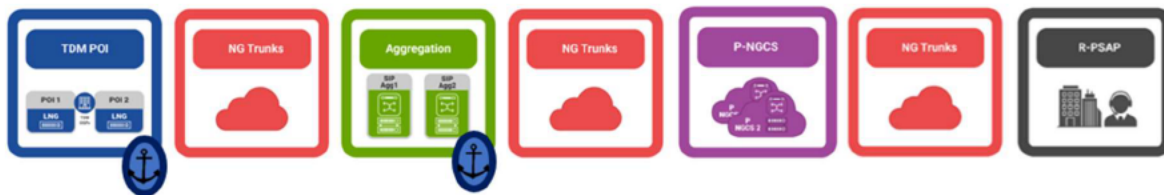

EXHIBIT 20: TECHNICAL REQUIREMENTS NARRATIVE RESPONSE

NGA 911, LLC

Exhibit 23: 23.0.16

Our NGCS, at its foundation, was built with modern age thinking. From the way we built our software to the NENA i3 standards tested in quality assurance. Our multi-layered redundancy cloud-based development and deployment ensures no single point of failure will be experienced in California, and that both hardware and software system components including but not limited to routers, router tables, servers, NGCS, and all NG9-1-1 functions can be updated without zero downtime.

NGA 911 brings a fresh, alternative approach to public safety when compared with the typical incumbents. Software development and deployment for 9-1-1 has typically been conducted with the waterfall method. The waterfall model is a development process that originated in the manufacturing and construction industries. It is a highly structured process that strictly restrains movement from one phase to the next. The motivation of this restriction comes from the prohibitively expensive phases of execution in physical environments. When applied to software these restrictions can feel draconian and counterproductive.

NGA stands in stark contrast with this antiquated paradigm. NGA 911 follows the agile manifesto. The 'Agile' method is a largely popular modern software development paradigm. Agile arose out of frustration for the 'monumental' methodologies of the past. Methodologies like Waterfall and TQM were born in the slower moving, less forgiving industries of physical goods manufacturing.

With 8 cores and a fully meshed access network, NGA 911's architecture provides a multi-layered redundancy of systems, software, and facilities with no single point of failure that far exceeds any competitor. Our solution is 99.999 available solution with the hardened infrastructure of Amazon Web Services (AWS). AWS has proven re-routes, resiliency, redundancy, and reliability. NGA 911 replicates critical system components across multiple Availability Zones (AZs) to ensure high availability both under normal circumstances and during disasters such as fires, tornadoes, or floods. Availability Zones consist of one or more discrete data centers, each with redundant power, networking, and connectivity and housed in separate facilities. Each AWS AZ runs on its own independent infrastructure, engineered to be highly reliable so that even extreme disasters or weather events should only affect a single Availability Zone. The data centers' electrical power systems are designed to be fully redundant and maintainable without impact to operations. Common points of failure, such as generators, UPS units, and air conditioning, are not shared across Availability Zones.

Every critical component of the ESInet has redundant and backup resources. NGA 911 has no single point of failure for the ESInet's critical functions like Border Control Function (BCF), Emergency Call Routing Function (ECRF), Emergency Services Routing Proxy (ESRP), logging service, and security services. This ensures that citizens who dial 9-1-1 will reach the appropriate agency who can provide emergency services without fail.

The NGA 911 ESInet is architected and configured to survive natural or man-made disasters at every core site (Central Office (CO), Point of Presence (POP), Data Center (DC) or other central switching location). All AWS data centers and direct connect facilities are designed to an Uptime Institute level of Tier III+ or above. The NGA 911 NGCS solution deploys dual Cores in AZs for a total of eight (8) Cores vs. the two (2) and six (6) of others in the industry. Having 8 cores allows us exceed this requirement with the ability to update all system components including routers, router tables, servers, that support our NGCS for all NG9-1-1 functions on without any loss of service 24x7x365.

Our Agile DevOps process is specifically and uniquely designed to facilitate an upgrade process that does not interrupt, degrade, or in any way negatively impact network connectivity or established functionality for any system user.

EXHIBIT 20: TECHNICAL REQUIREMENTS NARRATIVE RESPONSE
NGA 911, LLC

NGA 911 regularly and routinely back's up configuration data and performs software upgrades in accordance with our DevOps Process. Previous working configurations can be invoked and loaded in parallel with the current release to test side-by-side performance on active-active systems. New functions and features are subject to a thorough and robust testing in a pre-production environment. When code is ready for deployment the release process is structured to maintain the current load for a fixed period of time. Releases are made only on one copy of redundant deployments. The operational performance of new releases are continuously monitored to verify conformance with specifications. Any general release is completed when specifications are verified over a defined period. In an active-active environment, the performance of the new load is directly compared to the current load. In the case of an Operational Exception Fault (during Test Release and Full Release); Restoration or Fallback to previous version is automated so that both active-active instances are returned to the current stable release. These advanced practices ensure Cal OES and ESInet do not fall prey to the network failures due to poor release management which has befallen a number of PSAPs on a National Scale.

Diagram 126.1: Iterative, Continuous Assessment DevOps Process

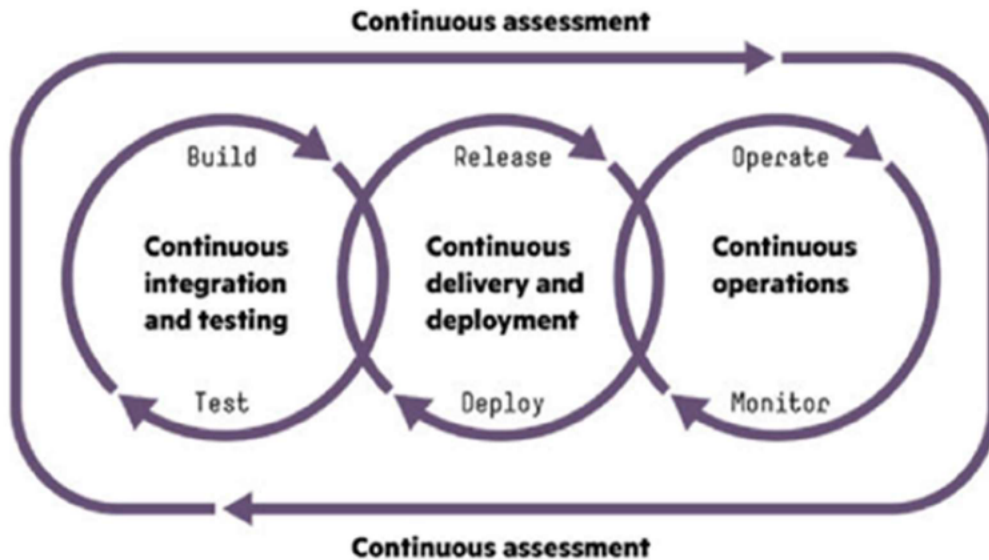

In order to maintain optimal, router, switch, and functional element configurations, NGA 911 adheres to the continuous assessment model depicted in the diagram above. Build types are characterized as being based on Customer Needs, on Enhancements, and on Operational Necessity. Each type is coded in an Agile manner and integrated into the Test Environment. After successful testing, the releases are delivered in the parallel active-active manner described above. Utilizing the capabilities of our NOC/SOC software defined WAN; direct and immediate comparisons are made between the new load and current release. Performance is verified on a number of metrics including end-to-end jitter, latency, MOS fidelity, and call response times for both. Any findings or measurements that fall out of the specified norm for the new release result in an automatic restoration to the current release.

EXHIBIT 20: TECHNICAL REQUIREMENTS NARRATIVE RESPONSE
NGA 911, LLC

[REDACTED]

[REDACTED]

NGCS	Non Redundant 1 AZ		Redundant 2 AZ		Redundant Region 2 AZ's each	
	Signaling	Media	Signaling	Media	Signaling	Media
AWS Data Plane	99.999%	99.999%	>59's	>59's	100%	100%
BCF	99.99%		>59's		100%	
ESRP	99.95%	99.95%	>59's	>59's	100%	100%
ECRF	99.95%		>59's		100%	
LVF	99.95%		>59's		100%	
	99.84%	99.95%	>59's	>59's	100%	100%

[REDACTED]

[REDACTED]

[REDACTED]

[REDACTED]

[REDACTED]

[REDACTED]

[REDACTED]

[REDACTED]

EXHIBIT 20: TECHNICAL REQUIREMENTS NARRATIVE RESPONSE
NGA 911, LLC

AWS Cloud Diverse Cores

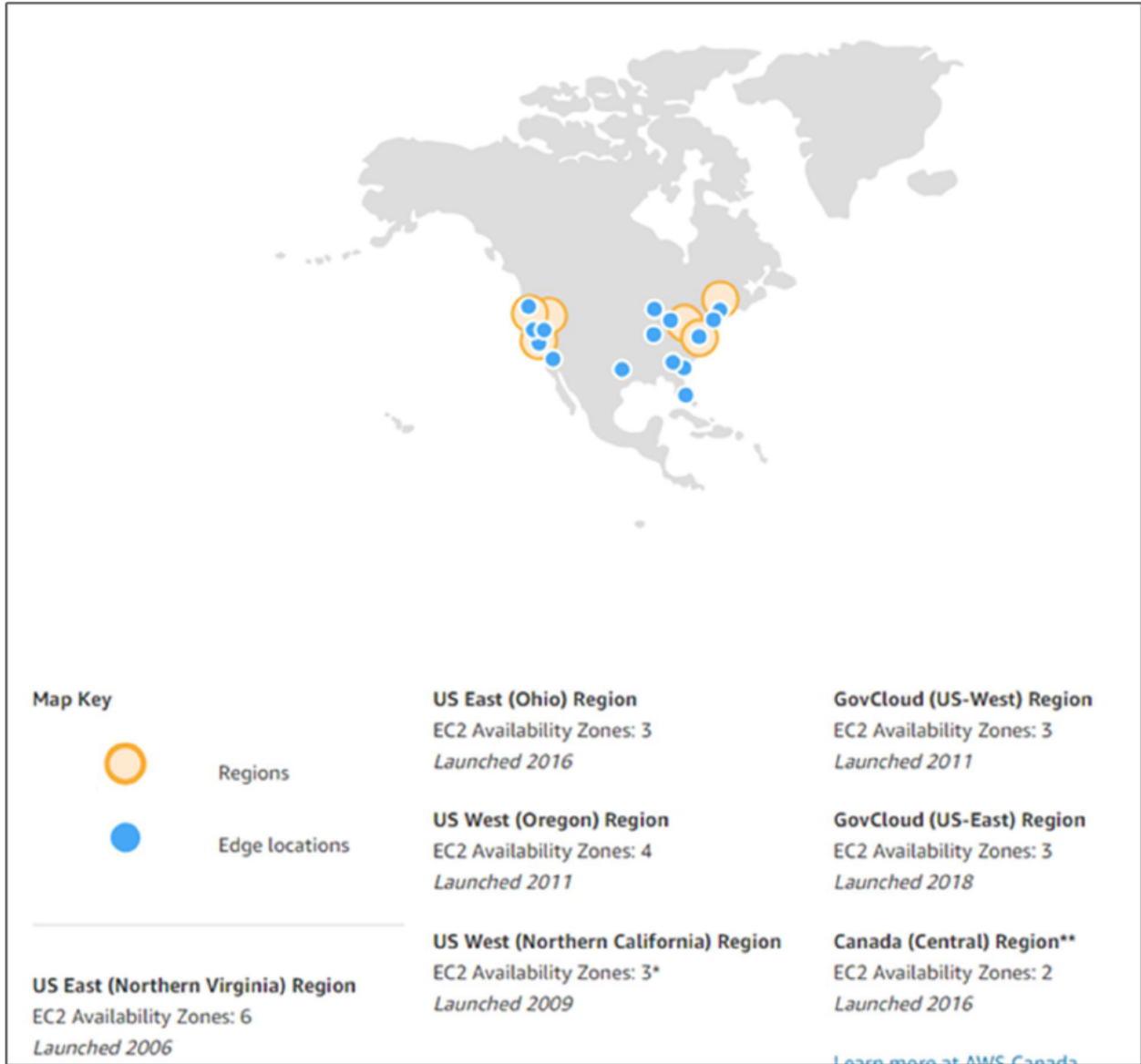

EXHIBIT 20: TECHNICAL REQUIREMENTS NARRATIVE RESPONSE
NGA 911, LLC

Google Cloud Diverse Cores



EXHIBIT 20: TECHNICAL REQUIREMENTS NARRATIVE RESPONSE
NGA 911, LLC

Exhibit 23: 23.0.18

Describe the maximum call volume the solution will support and how the proposed solution is scalable and the role licensing agreements with subcontractors have in scalability if applicable.

Response:

Maximum Call Volume

NGA 911 has near unlimited call volume. NGA 911 has proven, documented experience in this area, as we have tested call volumes ten times the volume of the entire State of California. These tests were conducted in adherence to RFC 7502 and can be reproduced at will. Details of these tests spanning 50+ pages are available upon request.

NGA 911 has already proven its ability to process large call volumes at a moment's notice for a population of 500,000,000 with 300,000,000 calls per year (125% of the U.S. total call volume). Which far exceeds the requirements of the State of California. Tests were conducted per [REDACTED]

[REDACTED] As a system designed with auto-scaling, the concept of a single instance/container does not exist for our architecture. Even if traffic was somehow restricted to one Availability Zone (AZ), the system upon reaching certain thresholds spins up additional containers to meet the demand.

Diagram 23.0.18.1 [REDACTED]

The tests had the following load:

Population	500,000,000
Calls per Year	300,000,000
Number of PSAPs	4,400
Dispatchers	18,000
Phones	3,600
Average Call Duration	120 seconds
Minimum Call Duration	10 seconds
Maximum Call Duration	600 seconds

Under heavy load, the system demonstrated vertical scaling, process distribution, and horizontal scaling with zero error.

Of equal importance is that every element, in detail, is tracked and presented to the Monitoring dashboard where performance statistics are actively gathered and presented, and alerting thresholds are set up for every stakeholder.

EXHIBIT 20: TECHNICAL REQUIREMENTS NARRATIVE RESPONSE NGA 911, LLC

Diagram 23.0.18.2 NGA 911 Test Labs – Text Lab for NG and Example Participants:

NGA 911 Testbed Status and Functional Test Report												
Operational												
PSAPs				Functional Features Tested								
Organization	Status	Start Date	Days	Routing	SIP Call Delivery	NG9-1-1 Call Delivery	Geolocation	HELD Update	Voice	RTT	Video	
		9/12/2018	296									
		1/30/2019	156				CPE-NR	CPE-NR		CPE-NR	CPE-NR	
		1/30/2019	156				CPE-NR	CPE-NR		CPE-NR	CPE-NR	
		1/24/2019	162		CPE-NR	CPE-NR	CPE-NR	CPE-NR	CPE-NR	CPE-NR	CPE-NR	
		1/28/2019	158		CPE-NR	CPE-NR	CPE-NR	CPE-NR	CPE-NR	CPE-NR	CPE-NR	
		5/28/2019	38		CPE-NR	CPE-NR	CPE-NR	CPE-NR	CPE-NR	CPE-NR	CPE-NR	
		6/21/2019	14			E911	E911	NT			NT	
Vendor Test Beds/Labs				Functional Features Tested								
Organization	Status	Start Date	Days	Routing	SIP Call Delivery	NG9-1-1 Call Delivery	Geolocation	HELD Update	Voice	RTT	Video	
		10/16/2018	262							CPE-NR	CPE-NR	
		10/9/2018	269							CPE-NR	CPE-NR	
		9/12/2018	296					CPE-NR		CPE-NR	CPE-NR	
		1/30/2019	156			*	CPE-NR	CPE-NR		CPE-NR	CPE-NR	
		6/6/2019	29							CPE-NR	CPE-NR	
		6/15/2019	20							CPE-NR	CPE-NR	

CPE-NR = CPE Vendor Not Ready to Test

* Call is Delivered and Received but CPE is not i3 Ready

NT = Not Tested

No Sub Contractors on our Core NGCS Product

Licensing with subcontractors has no role in NGA 911's ability to scale.

NGA 911's NGCS operates on the Linux operating system. A decision we took several years prior. We avoided Windows because the challenge with windows deployments (other than reliability and scalability) is the difference in license cost for desktop and server versions. Not only does the OS cost, but related applications cost, so the risk of hidden and unexpected expenses in deployments increases substantially.

NGA's NGCS is the core software product we have built specifically for transitioning the 9-1-1 system from legacy to NG infrastructure. We have no outsourced elements in our solution, therefore, we have no cost, external development timeline, or external licensing risks to our deployment and scaling. Additionally, our R&D team is especially well positioned to respond to all challenges presented by California's IP cutover since we control and have mastery over every byte of code.

Cybersecurity Risks of Windows

Since Cal OES has raised the issue of "licensing," we presume Windows has been proposed as a viable solution. So, we'll go a bit further in our discussion about the implications of using Windows in the processing of 9-1-1 calls. Microsoft Windows OS is infamous for being vulnerable to malware, trojans, and viruses. Linux is almost non-vulnerable and more secure due to its inherent design. Linux does not require the use of commercial anti-virus/anti-malware packages.

Proven Server Platform

It should be further noted that the majority of supercomputers run on Linux. Case in point, Windows can be a container within Kubernetes, not vice versa. Windows Server OS would not be trusted for such heavy lifting since organizations cannot afford rebooting mission critical servers. Though the battle between Linux and Windows continues in desktop-segment when it comes to the server-segment Linux is the clear winner. Organizations rely on servers because they want their applications to run 24x7x365 with limited downtime. Linux has already become a favorite of most of the data centers.

Real Scaling in the Cloud

NGA 911 currently has four distinct ESInets [REDACTED]. Each of these deployments is isolated and independently scalable. Every ESInet we deploy has independent scalability at both the container and instance levels.

EXHIBIT 20: TECHNICAL REQUIREMENTS NARRATIVE RESPONSE
NGA 911, LLC

Exhibit 23: 23.0.19

List all subcontractors that will be used for NGCS. There is potential for some subcontractors to be used by multiple RNSP's or the PNSP. In that scenario, describe the bidder's strategy to prevent or mitigate one subcontractor's outage from causing an outage in multiple regions. Bidder shall describe how their solution provides an autonomous solution for NGCS.

Response:

No subcontractors for Our Core Product NGCS

NGA set forth several years ago to build the platform that would transition us from the legacy to NG9-1-1 system. Our platform was built from the ground up for this specific purpose. Every part of our NGCS is built internally with no subcontract code or systems, so there is no potential for a subcontractors' outage, whether by coding or architecture mishap, that would affect our region(s); thereby removing a point of failure.

The NGA 911 solution adds an additional layer of redundancy and resilience to California's deployment.

Quality Control

Since we built and own every byte of code in our NGCS platform, we are fully accountable and guarantee the quality of our software code.

Triggering R&D Resources

NGA 911's NGCS is not exposed to the risk of external priorities, outside of NGA 911, delaying or hampering project deployment. Patches and bug fixes are a priority according to our senior management, so we are not dependent upon any outside organizations. In other words, a phone call to NGA 911 senior management has an immediate impact on NGA 911 R&D priorities.

Each Region Will be an Autonomous Cloud Solution

NGA 911 has demonstrated through the deployment of several ESInets that include NGCS, that every deployment is autonomous. Every deployment has independent monitoring, instances, network, and an independent NGCS build. In California each region would be independent and autonomous.

NGA 911's Additional Project Risk Mitigation

We fully expect that one of the risks to the IP cutover is the small details that are not known at the project's outset that impede and delay project success. We are the only vendor who has actively pursued and engaged Carriers and PSAPs in our "Three Steps to NG9-1-1 Program." We have thus discovered and incorporated many of these small details into our NGCS, and understand that not every detail is known at the outset of a project. So, a substantial risk to the project will be capturing and handling these small details as they impede IP cutover success. Handling these details must be swift, thorough, and collaborative, which we have demonstrated in every one of our "Three Step Programs."

EXHIBIT 23
Narrative Requirements - Region

CA NG9-1-1 - Region Technical Requirements Summary

- 23.0 Region Narrative Requirements
- 23.1 Region Functions and Services
- 23.2 Region NG Core Services
- 23.3 Region Aggregation Services
- 23.4 NG9-1-1 Trunk Services
- 23.5 Region Integration with Statewide GIS

Requirement	Bidder shall provide a written narrative for the requirements noted in Exhibit 23.0 and include with its Final Bid Submission in accordance with Section 6, Proposal/Bid Format and Submission Requirements	Region Network Service Provider Agrees to meet the Requirement YES/NO	Tariff Service Info
<u>Interface, Compatibility, and Interoperability - Region</u>			
23.0.0	Describe the key success factors for the RNSP and how the RNSP will measure, monitor, and ensure timely implementation of NG 9-1-1 services. The description must include challenges and mitigation strategies that impact the project's critical path, and how the RNSP will comply with project plans and interfaces set by the PNSP.		
23.0.1	Describe the process using a non-proprietary NENA i3 compliant solution to route any 9-1-1 traffic to the correct PSAP within California for the awarded Regional NG Core Services, or when the Prime routes a call to the awarded region.		
23.0.2	Describe the process to route any 9-1-1 traffic to the Prime when the awarded region is unable to deliver the call to the correct PSAP. Description should include how this function will be supported when there is a complete loss of awarded region NG 9-1-1 services, and when the correct PSAP is not directly connected to the awarded region, and when the correct PSAP is connected to the awarded region, but is unreachable due to network or transport outage.		
23.0.3	Describe the program management, collaboration and communication needed for the RNSP to comply with the best practices and interfaces developed for POI, aggregation, Region to Prime interface and Region/Prime interface to PSAP by the PNSP in coordination with the CA 9-1-1 Branch that demonstrates a commitment to transparency.		
23.0.4	Describe how the solution will support Location Based Routing using location data provided by either an Originating Service Provider, a device operating system, or a location clearing house, as directed by the CA 9-1-1 Branch.		
23.0.5	Describe the methodology that will be employed after contract award to ensure NG9-1-1 services provided are consistent with tariff filings.		

23.0.5.1	Of the four regions, what is your preferred region and why your company would have an advantage in that region? Why is this region assignment in the best interest of The State? The State makes no guarantee preferences will be accommodated and region assignment is determined solely by the State to achieve the best NG 9-1-1 solution.		
----------	---	--	--

NG Statewide 9-1-1 GIS			
23.0.6	Describe how the RNSP shall utilize the statewide GIS database that is maintained and updated by the NG 9-1-1 Prime vendor for routing all 9-1-1 traffic.		
23.0.7	Describe the Emergency Call Routing Function (ECRF) and Location Validation Functions (LVF) that comply with GIS standards that include but not be limited to NENA STA-010.2-2016 Detailed Functional and Interface Standards for the NENA i3 Solution. Description shall include how the ECRF will updated based on GIS changes published by the PNSP.		
23.0.7.1	List all subcontractors that will be used for ECRF/LVF. There is potential for some subcontractors to be used by multiple RNSP's or the PNSP. In that scenario, describe the bidder's strategy to prevent or mitigate one subcontractor's outage from causing an outage in multiple regions. Bidder shall describe how their solution provides an autonomous solution for ECRF/LVF.		

System Monitoring			
23.0.8	Describe how the dashboard will display and report the health of the Regional network from ingress to egress. Description should include how the Dashboard shall monitor all 9-1-1 traffic in the assigned region and all NG9-1-1 trunks to ensure that SLAs are being met. Description shall also include how CA 9-1-1 Branch will access the Dashboard Monitoring, this shall include statistical data, printable reports, and outage notifications with duration.		
23.0.9	Describe the integration of system monitoring with data pushed from Regional network to PNSP. Description shall include how to integrate the e-bonded trouble ticket process.		
23.0.10	Describe realistic timeline for Dashboard development that includes at a minimum Real Time Network Outage Monitoring and Reporting to support the description given for 23.0.8.		

Aggregation			
--------------------	--	--	--

23.0.11	Describe the OSP traffic aggregation service for all wireless, AT&T wireline, Consolidated Communications wireline, and Frontier wireline OSPs in the awarded region in the State of California. Describe how the POI locations will be determined to support the ingress of OSP traffic, and how they will work with the OSP, CA 9-1-1 Branch and the CPUC throughout this process.		
23.0.12	Describe how the bidders proposed aggregation plan complies with the SOW and Exhibit 23. Description shall include the solutions ability to transfer between regions, or if PSAP is not reachable then shall send to Prime for delivery to PSAP.		
23.0.12.1	List all subcontractors that will be used for aggregation. There is potential for some subcontractors to be used by multiple RNSP's or the PNSP. In that scenario, describe the bidder's strategy to prevent or mitigate one subcontractor's outage from causing an outage in multiple regions. Bidder shall describe how their solution provides an autonomous solution for aggregation.		

NG Core Services			
23.0.13	Describe how the bidder will receive, maintain, and push the centralized policy routing instructions for the region.		
23.0.14	Describe the security and firewalls needed to protect NG9-1-1 Services in accordance with NENA NG-SEC 75-001. The solution must be able to detect, mitigate and report TDOS, DDOS and any other Cyber attacks.		
23.0.15	Provide a diagram(s) that shows 9-1-1 traffic flow architecture from ingress to egress using a non-proprietary NENA i3 compliant solution with dedicated NG Core Services for California.		
23.0.16	Describe how NGCS shall use a non-proprietary NENA i3 compliant multi-layered redundancy of systems, software, and facilities with no single point of failure that supports the ability to update all system components including but not limited to routers, router tables, servers, NG Core Services, and all NG9-1-1 functions without any loss of service 24x7x365.		
23.0.17	Describe how the bidders solution will support a minimum of two geographically diverse cores or a cloud based equivalent, dedicated to California and located in the CONUS, with the capability to maintain 99.999% availability.		
23.0.18	Describe the maximum call volume the solution will support and how the proposed solution is scalable and the role licensing agreements with subcontractors have in scalability if applicable.		

23.0.19	List all subcontractors that will be used for NGCS. There is potential for some subcontractors to be used by multiple RNSP's or the PNSP. In that scenario, describe the bidder's strategy to prevent or mitigate one subcontractor's outage from causing an outage in multiple regions. Bidder shall describe how their solution provides an autonomous solution for NGCS.		
---------	---	--	--

Requirement	Mandatory Region Functions & Services Requirements The requirements are organized into General Requirements and then more specific requirements for each deployment method.	Region Network Service Provider Agrees to meet the Requirement? YES/NO	Tariff Service Info
23.1.1	Shall not charge OSPs, 9-1-1 Service Providers, CPE providers, or any other service provider from ingress to egress of the 9-1-1 traffic, as these services in their entirety are paid for by the State of California.	YES	NGA 911, LLC (U-7347-C) Emergency Services - Region Functions and Services - Sheet No 70, Item #1
23.1.2	Implement NENA i3 standards and CPE delivery standards, as directed by CA 9-1-1 Branch, for each of the defined regions to support CA statewide interoperability.	YES	NGA 911, LLC (U-7347-C) Emergency Services - Region Functions and Services - Sheet No 70, Item #2
23.1.3	Have a minimum of two (2) geographically diverse Cores or the cloud based equivalent, within CONUS, dedicated to California with demonstrated capability that provides 99.999% availability.	YES	NGA 911, LLC (U-7347-C) Emergency Services - Region Functions and Services - Sheet No 70, Item #3
23.1.4	Shall comply with the overall management and direction of standards and best practices for consistency of 9-1-1 traffic between the Regions and Prime as determined by CA 9-1-1 Branch and the selected Prime NG9-1-1 vendor.	YES	NGA 911, LLC (U-7347-C) Emergency Services - Region Functions and Services - Sheet No 70, Item #4
23.1.5	Shall process and route any 9-1-1 traffic within California for the region awarded, including the 9-1-1 traffic transferred from the Prime to the awarded region.	YES	NGA 911, LLC (U-7347-C) Emergency Services - Region Functions and Services - Sheet No 70, Item #5
23.1.6	Process and route all wireless, AT&T wireline, Consolidated Communications wireline, and Frontier wireline OSP traffic in the Region awarded in the State of California, and any other regional OSP traffic that is not routed by the Prime.	YES	NGA 911, LLC (U-7347-C) Emergency Services - Region Functions and Services - Sheet No 70, Item #6

23.1.7	Shall be responsible to either pull, or receive a push of the centralized policy routing instructions maintained by the Prime that will be used in all of the regions.	YES	NGA 911, LLC (U-7347-C) Emergency Services - Region Functions and Services - Sheet No 70, Item #7
23.1.8	Shall be responsible for notifying CA 9-1-1 Branch of updates needed to Policy Routing in the awarded region.	YES	NGA 911, LLC (U-7347-C) Emergency Services - Region Functions and Services - Sheet No 70, Item #8
23.1.9	Shall provide the security and firewalls needed to protect NG9-1-1 Services in accordance with NENA NG-SEC 75-001. The Network Service Provider shall detect, prevent and report TDOS, DDOS and any other Cyber attacks.	YES	NGA 911, LLC (U-7347-C) Emergency Services - Region Functions and Services - Sheet No 70, Item #9
23.1.10	Shall agree to the CA 9-1-1 Branch utilizing a third party vendor to validate network security for all NG9-1-1 Services, in accordance with NENA NG-Sec 75-001 and subsequent standards.	YES	NGA 911, LLC (U-7347-C) Emergency Services - Region Functions and Services - Sheet No 70, Item #10

<p>23.1.11</p>	<p>The current NENA approved security standard (NENA-INF-015.1-2016, NENA 75-001, NENA 75-502) Security for Next-Generation 9-1-1 Standard (NG-SEC) Standard and the associated NENA Next Generation 9-1-1 Security (NENA-INF-023.1-2017, NENA 75-002 - NG-SEC Audit Checklist) are required to be implemented. As the NENA security requirements evolve and mature and at the request of CA 9-1-1 Branch, Network Service Provider shall provide a plan to implement updates, adjustments, or modifications to maintain compliance with the current NENA security standard. The Network Service Provider shall monitor additional security repositories to identify threats and vulnerabilities to the system in the context of avoiding cybersecurity issues. Sites that are often utilized such as https://cve.mitre.org/, https://nvd.nist.gov/, and https://www.us-cert.gov/ can assist in the identification and analysis of potential vulnerabilities within the NGCS. Once a vulnerability or a threat has been identified, the Network Service Provider shall perform the initial and emergency response to the security event and will have no more than 24 hours to provide CA 9-1-1 Branch a document describing the measures taken, and any additional implementation plans to fully avoid a breach.</p>	<p>YES</p>	<p>NGA 911, LLC (U-7347-C) Emergency Services - Region Functions and Services - Sheet No 70, Item #11</p>
<p>23.1.12</p>	<p>Shall supply a Configuration management database that documents all of the software, systems, network protocols, port usage and relevant system related information in a mutually agreed upon format. This configuration database shall include a linkage to their change management process to ensure that any change request that is implemented will result in update to the configuration management database. The shall follow industry standards best practices such as ITIL or the equivalent, and shall maintain a configuration management database that can be accessed by CA 9-1-1 Branch. Items that need to be included in the configuration management database include:</p> <ul style="list-style-type: none"> o Bandwidth at each interface o Capacity and demand management as adjustments to the interfaces o Access management and any adjustments to the identification and access management to the NGCS o Service Level and Performance adjustments to adhere to the SLA o Security changes and adjustments – Physical and Operational o Configuration database dashboard or other method to allow real time access to the CA 9-1-1 Branch o As-built information contained in the system as the baseline configuration to provide a historical 	<p>YES</p>	<p>NGA 911, LLC (U-7347-C) Emergency Services - Region Functions and Services - Sheet No 71, Item #12</p>

23.1.13	Shall provide 9-1-1 traffic flow architecture from ingress to egress.	YES	NGA 911, LLC (U-7347-C) Emergency Services - Region Functions and Services - Sheet No 71, Item #13
23.1.14	Shall interface with the selected Prime NG9-1-1 vendor at each PSAP, as directed by CA 9-1-1 Branch.	YES	NGA 911, LLC (U-7347-C) Emergency Services - Region Functions and Services - Sheet No 71, Item #14
23.1.15	The RNSP shall work with OSPs to validate the LVF maintained by PNSP so they can verify that civic addresses will return PSAP or emergency responder URIs. The PNSP LVF shall be made available via an LVF proxy in the public internet in a secure controlled manner provided by the PNSP. The RNSP LVF shall receive updates from the PNSP.	YES	NGA 911, LLC (U-7347-C) Emergency Services - Region Functions and Services - Sheet No 71, Item #15
23.1.16	Shall connect to Prime and comply with interoperability as directed by Prime at the direction of CA 9-1-1 Branch.	YES	NGA 911, LLC (U-7347-C) Emergency Services - Region Functions and Services - Sheet No 71, Item #16
23.1.17	Shall utilize the PNSP defined and CA 9-1-1 Branch approved interface at aggregation, between regional and prime, at PSAP and for all other interoperability interfaces.	YES	NGA 911, LLC (U-7347-C) Emergency Services - Region Functions and Services - Sheet No 71, Item #17
23.1.18	Shall support Location Based Routing using location data provide by either an Originating Service Provider, a device operating system, or a location clearing house as directed by the CA 9-1-1 Branch.	YES	NGA 911, LLC (U-7347-C) Emergency Services - Region Functions and Services - Sheet No 71, Item #18
23.1.19	Shall support the NENA i3 standards and guarantee a non-proprietary solution that supports interoperability.	YES	NGA 911, LLC (U-7347-C) Emergency Services - Region Functions and Services - Sheet No 71, Item #19

<p>23.1.20</p>	<p>Shall provide services to process location data integration similar to Advanced Mobile Location (AML) for emergency location-based service that can support Data SMS and HTTPS data message formats and shall integrate the data as supplemental location information integrated into CPE that is capable of displaying the best available geolocation of the caller to a dedicated end-point as determined by CA 9-1-1 Branch.</p>	<p>YES</p>	<p>NGA 911, LLC (U-7347-C) Emergency Services - Region Functions and Services - Sheet No 71, Item #20</p>
<p>23.1.21</p>	<p>RNSP shall connect in to the network master clock provided by PNSP. The PNSP provided master clock shall meet the NENA PSAP Master Clock Standard.</p>	<p>YES</p>	<p>NGA 911, LLC (U-7347-C) Emergency Services - Region Functions and Services - Sheet No 71, Item #21</p>
<p>23.1.22</p>	<p>RNSP shall provide a connection using an NG9-1-1 Trunk to the CA 9-1-1 Branch NG 9-1-1 Lab and shall participate in all acceptance testing in the NG 9-1-1 Lab environment or in other mutually agreed upon laboratory locations.</p>	<p>YES</p>	<p>NGA 911, LLC (U-7347-C) Emergency Services - Region Functions and Services - Sheet No 71, Item #22</p>

Requirement	Mandatory NG Core Services Requirements The requirements are organized into General Requirements and then more specific requirements for each deployment method.	Region Network Service Provider Agrees to meet the Requirement? YES/NO	Tariff Service Info
23.2.1	Shall use a multi-layered redundancy of systems, software and facilities with no single point of failure	Yes	NGA 911, LLC (U-7347-C) Emergency Services - Region NG Core Services - Sheet No 72, Item #1
23.2.2	Shall provide the ability to update all system components including but not limited to routers, router tables, servers, NG Core Services, and all NG9-1-1 functions without loss of service 24x7x365.	Yes	NGA 911, LLC (U-7347-C) Emergency Services - Region NG Core Services - Sheet No 72, Item #2
23.2.3	Shall be responsible to log all 9-1-1 metadata traffic for awarded region.	Yes	NGA 911, LLC (U-7347-C) Emergency Services - Region NG Core Services - Sheet No 72, Item #3
23.2.4	Shall provide NENA i3 logging for all functional elements within the NGCS.	Yes	NGA 911, LLC (U-7347-C) Emergency Services - Region NG Core Services - Sheet No 72, Item #4
23.2.5	Shall be responsible to send i3 logging data and other system monitoring data from the awarded NG Region to the NG9-1-1 Prime selected vendor.	Yes	NGA 911, LLC (U-7347-C) Emergency Services - Region NG Core Services - Sheet No 72, Item #5
23.2.6	Shall utilize SIP metadata and i3 logging to monitor, track and verify data flow.	Yes	NGA 911, LLC (U-7347-C) Emergency Services - Region NG Core Services - Sheet No 72, Item #6

23.2.7	Shall be able to provide a data push and/or pull of i3 logging data to and from Prime NG9-1-1 service provider.	Yes	NGA 911, LLC (U-7347-C) Emergency Services - Region NG Core Services - Sheet No 72, Item #7
23.2.8	Shall provide NG9-1-1 services built upon the NENA i3 requirements and standards documents. The NENA i3 solution shall support end to end IP connectivity. Gateways shall be used to accommodate legacy wireline and wireless origination networks as well as legacy PSAPs that interconnect to the NENA i3 solution architecture.	Yes	NGA 911, LLC (U-7347-C) Emergency Services - Region NG Core Services - Sheet No 72, Item #8
23.2.9	Shall provide Emergency Call Routing Function (ECRF) and Location Validation Functions (LVF) that comply with GIS standards that include but not be limited to NENA STA-010.2-2016 Detailed Functional and Interface Standards for the NENA i3 Solution.	Yes	NGA 911, LLC (U-7347-C) Emergency Services - Region NG Core Services - Sheet No 72, Item #9
23.2.10	Shall provide Emergency Services Routing Proxy (ESRP) to perform the IP routing of all calls through the NG9-1-1 system based on information from the SIP header.	Yes	NGA 911, LLC (U-7347-C) Emergency Services - Region NG Core Services - Sheet No 72, Item #10
23.2.11	Shall provide a PRF which is a functional component of an ESRP that determines the next hop in the SIP signaling path using the policy of the nominal next element determined by querying the ECRF with the location of the emergency calling party.	Yes	NGA 911, LLC (U-7347-C) Emergency Services - Region NG Core Services - Sheet No 72, Item #11
23.2.12	Shall be capable of transferring calls utilizing functions like ECRF/PRF, to/from the Prime NG Service Provider or PSTN including the delivery of accurate emergency calling party location information.	Yes	NGA 911, LLC (U-7347-C) Emergency Services - Region NG Core Services - Sheet No 72, Item #12
23.2.13	Shall utilize the Border Control Function (BCF) as part of the NGCS to manage network edge control and SIP message handling in accordance with the NENA i3 requirements.	Yes	NGA 911, LLC (U-7347-C) Emergency Services - Region NG Core Services - Sheet No 72, Item #13

23.2.14	Shall utilize the BCF, both ingress and egress, to support the following security related techniques including Monitoring, Detections, Prevention, and Response.	Yes	NGA 911, LLC (U-7347-C) Emergency Services - Region NG Core Services - Sheet No 72, Item #14
23.2.15	Shall provide at least two (2) ECRF/LVF instances utilized for the NGCS.	Yes	NGA 911, LLC (U-7347-C) Emergency Services - Region NG Core Services - Sheet No 72, Item #15
23.2.16	Shall provide a dashboard to display and report the health of the awarded Regional networks from ingress to egress. The solution shall provide QoS information, per NENA i3 standards.	Yes	NGA 911, LLC (U-7347-C) Emergency Services - Region NG Core Services - Sheet No 72, Item #16
23.2.17	Shall include at a minimum Real Time Network Outage Monitoring and Reporting for Regions to support failover interoperability and 9-1-1 traffic, show network uptime and downtime duration in the dashboard.	Yes	NGA 911, LLC (U-7347-C) Emergency Services - Region NG Core Services - Sheet No 72, Item #17
23.2.18	Shall monitor all 9-1-1 traffic to ensure that SLAs are being met in the dashboard.	Yes	NGA 911, LLC (U-7347-C) Emergency Services - Region NG Core Services - Sheet No 73, Item #18
23.2.19	Shall provide CA 9-1-1 Branch access to Dashboard Monitoring and statistical data and printable reports.	Yes	NGA 911, LLC (U-7347-C) Emergency Services - Region NG Core Services - Sheet No 73, Item #19
23.2.20	Shall retain all network, CDR and 9-1-1 traffic data for a period of ten (10) years.	Yes	NGA 911, LLC (U-7347-C) Emergency Services - Region NG Core Services - Sheet No 73, Item #20
23.2.21	Shall log and report all 9-1-1 traffic.	Yes	NGA 911, LLC (U-7347-C) Emergency Services - Region NG Core Services - Sheet No 73, Item #21

23.2.22	Shall provide CA 9-1-1 Branch access to Dashboard Monitoring and statistical data and printable reports. The Dashboard Monitoring service shall be a dedicated resource for California to support this contract.	Yes	NGA 911, LLC (U-7347-C) Emergency Services - Region NG Core Services - Sheet No 73, Item #22
23.2.23	Shall provide ability to dispatch technical support to any location where the contractor has equipment within 30 minutes of notifying technician of an outage that requires on-site technical support.	Yes	NGA 911, LLC (U-7347-C) Emergency Services - Region NG Core Services - Sheet No 73, Item #23
23.2.24	Shall provide a point of contact, with a toll free telephone number, 365/24/7 for CA 9-1-1 Branch personnel and PSAP personnel to report trouble on the Prime NG9-1-1 Services.	Yes	NGA 911, LLC (U-7347-C) Emergency Services - Region NG Core Services - Sheet No 73, Item #24
23.2.25	Shall comply with NENA i3 PSAP integration standards established by CA 9-1-1 Branch that align with the NG9-1-1 Prime Selected Vendor integration standard.	Yes	NGA 911, LLC (U-7347-C) Emergency Services - Region NG Core Services - Sheet No 73, Item #25
23.2.26	Where the NENA i3 standard does not clearly define technical details, shall comply with CA 9-1-1 Branch and NG9-1-1 Prime selected vendor standards.	Yes	NGA 911, LLC (U-7347-C) Emergency Services - Region NG Core Services - Sheet No 73, Item #26
23.2.27	Shall use the data provided by the PNSP LDB and PNSP LVF to support the RNSP LVF validation function of the RNSP to ensure the LoST protocol is supported. The goal is to ensure that the PNSP remains the authoritative source for the LoST protocol.	Yes	NGA 911, LLC (U-7347-C) Emergency Services - Region NG Core Services - Sheet No 73, Item #27

Requirement	Mandatory NG9-1-1 Aggregation Services Requirements The requirements are organized into General Requirements and then more specific requirements for each deployment method.	Region Network Service Provider Agrees to meet the Requirement YES/NO	Tariff Service Info
23.3.1	The Region Network Service Provider and any subcontractor providing aggregation services must have a CPCN and tariff filing.	Yes	NGA 911, LLC (U-7347-C) Emergency Services - Region Aggregation Services - Sheet No 74, Item #1
23.3.2	Shall provide an OSP traffic aggregation service for all wireless, AT&T wireline, Consolidated Communications Wireline, and Frontier wireline OSPs in the Region awarded in the State of California.	Yes	NGA 911, LLC (U-7347-C) Emergency Services - Region Aggregation Services - Sheet No 74, Item #2
23.3.3	Shall have a minimum of two (2) geographically diverse aggregation locations per CA 9-1-1 Branch awarded NG Region.	Yes	NGA 911, LLC (U-7347-C) Emergency Services - Region Aggregation Services - Sheet No 74, Item #3
23.3.4	Shall have a minimum of two (2) POIs per CA 9-1-1 Branch awarded NG Region.	Yes	NGA 911, LLC (U-7347-C) Emergency Services - Region Aggregation Services - Sheet No 74, Item #4
23.3.5	Shall be connected to the Prime Aggregation Service providers to support the ingress of OSP traffic.	Yes	NGA 911, LLC (U-7347-C) Emergency Services - Region Aggregation Services - Sheet No 74, Item #5

23.3.6	Shall provide ability to determine if Regional core services are available to reach PSAP before sending to Region, if PSAP is not reachable then shall send to Prime for delivery to PSAP.	Yes	NGA 911, LLC (U-7347-C) Emergency Services - Region Aggregation Services - Sheet No 74, Item #6
23.3.7	Shall conform to the integration standards developed by CA 9-1-1 Branch and the NG9-1-1 Prime selected vendor for aggregation.	Yes	NGA 911, LLC (U-7347-C) Emergency Services - Region Aggregation Services - Sheet No 74, Item #7
23.3.8	Shall provide outage notifications to CA 9-1-1 Branch.	Yes	NGA 911, LLC (U-7347-C) Emergency Services - Region Aggregation Services - Sheet No 74, Item #8
23.3.9	Shall provide outage notifications with duration to system monitoring dashboard.	Yes	NGA 911, LLC (U-7347-C) Emergency Services - Region Aggregation Services - Sheet No 74, Item #9

Requirement	Mandatory NG9-1-1 Trunk Services Requirements The requirements are organized into General Requirements and then more specific requirements for each deployment method.	Region Network Service Provider Agrees to meet the Requirement YES/NO	Tariff Service Info
23.4.1	Shall comply with NENA i3 standards for 9-1-1 traffic delivery. NENA-STA-010.2-2016 and later versions.	Yes	NGA 911, LLC (U-7347-C) Emergency Services - Region NG9-1-1 Trunk Services - Sheet No 75, Item #1
23.4.2	Shall provide path diversity with both physical and carrier diversity. The CA 9-1-1 Branch understands that all bandwidths for NG 9-1-1 trunks may not be supported at all PSAPs and will work with the RNSP to determine path diversity. For each of the PSAP locations the individual circuits being provisioned to the site, by RNSP, shall meet CA 9-1-1 Branch carrier diversity/redundancy standards. CA 9-1-1 Branch shall be the sole arbitrator in determining their approval of the proposed circuit provider, the route and PSAP point of entry or other guidelines they deem essential to deliver redundancy.	Yes	NGA 911, LLC (U-7347-C) Emergency Services - Region NG9-1-1 Trunk Services - Sheet No 75, Item #2
23.4.3	NG9-1-1 Trunk service shall allow for 9-1-1 call isolation by stream or channel or via other means to enable the tracking of 9-1-1 traffic from ingress at the OSP to egress at the PSAP or to PNSP.	Yes	NGA 911, LLC (U-7347-C) Emergency Services - Region NG9-1-1 Trunk Services - Sheet No 75, Item #3
23.4.4	NG9-1-1 trunk service shall support a minimum of 10Mbps throughput, unless directed by CA 9-1-1 Branch.	Yes	NGA 911, LLC (U-7347-C) Emergency Services - Region NG9-1-1 Trunk Services - Sheet No 75, Item #4
23.4.5	Shall utilize NG9-1-1 Trunk service to connect to all California PSAPs, Prime NG Core Service provider, aggregation, and all other interfaces.	Yes	NGA 911, LLC (U-7347-C) Emergency Services - Region NG9-1-1 Trunk Services - Sheet No 75, Item #5

23.4.6	Shall transport NG9-1-1 traffic and other 9-1-1 related traffic included but not limited to NG9-1-1 Alert and Warning, as directed by CA 9-1-1 Branch.	Yes	NGA 911, LLC (U-7347-C) Emergency Services - Region NG9-1-1 Trunk Services - Sheet No 75, Item #6
23.4.7	Shall provide ability to monitor throughput statistics in real time.	Yes	NGA 911, LLC (U-7347-C) Emergency Services - Region NG9-1-1 Trunk Services - Sheet No 75, Item #7
23.4.8	Shall provide outage notifications to CA 9-1-1 Branch.	Yes	NGA 911, LLC (U-7347-C) Emergency Services - Region NG9-1-1 Trunk Services - Sheet No 75, Item #8
23.4.9	Shall provide outage notifications with duration to system monitoring dashboard.	Yes	NGA 911, LLC (U-7347-C) Emergency Services - Region NG9-1-1 Trunk Services - Sheet No 75, Item #9
23.4.10	Shall provide a private hosted SDWAN Controller by RNSP that interoperate with PNSP accessible over private network, including secure connectivity, trust and identity, and threat defense from PSAP to OSP / SaaS applications.	Yes	NGA 911, LLC (U-7347-C) Emergency Services - Region NG9-1-1 Trunk Services - Sheet No 75, Item #10
23.4.11	SD WAN shall include transport independence. Centrally managed and shared VPN schema across any WAN circuit (i.e. CAPSNET Microwave, LTE, MPLS, broadband, etc.) and shall support flexible VPN extension to all end points (IaaS, PSAP branch, PSAP DC)	Yes	NGA 911, LLC (U-7347-C) Emergency Services - Region NG9-1-1 Trunk Services - Sheet No 75, Item #11
23.4.12	Shall provide a secure SD WAN architecture that supports open security standards such as IPsec etc.	Yes	NGA 911, LLC (U-7347-C) Emergency Services - Region NG9-1-1 Trunk Services - Sheet No 75, Item #12

Requirement	Mandatory Statewide GIS Requirements The requirements are organized into General Requirements and then more specific requirements for each deployment method.	Region Network Service Provider Agrees to meet the Requirement YES/NO	Tariff Service Info
23.5.1	Shall utilize the statewide GIS database maintained and updated by the NG9-1-1 Prime vendor to update PNSP ECRF for routing all 9-1-1 traffic.	Yes	NGA 911, LLC (U-7347-C) Emergency Services - Statewide GIS - Sheet No 76, Item #1
23.5.2	Shall comply with GIS standards to include, but not limited to, NENA NG9-1-1 GIS Data Model, NENA 02-010, and NENA 02-014.	Yes	NGA 911, LLC (U-7347-C) Emergency Services - Statewide GIS - Sheet No 76, Item #2
23.5.3	Shall receive updates to the GIS database from the PNSP, without disruption of ECRF LoST service. Updates shall be at least daily and shall be capable of receiving data updates 24x7x365 and provide confirmation receipt of data within 4 hours.	Yes	NGA 911, LLC (U-7347-C) Emergency Services - Statewide GIS - Sheet No 76, Item #3
23.5.4	Shall provide a maintenance function to upload the data from the statewide GIS dataset to update the ECRF and LVF to ensure proper routing of calls.	Yes	NGA 911, LLC (U-7347-C) Emergency Services - Statewide GIS - Sheet No 76, Item #4
23.5.5	Shall interface with the statewide 9-1-1 GIS synchronization and 9-1-1 database normalization	Yes	NGA 911, LLC (U-7347-C) Emergency Services - Statewide GIS - Sheet No 76, Item #5
23.5.6	Shall utilize the PNSP database management services needed for NG9-1-1 traffic delivery.	Yes	NGA 911, LLC (U-7347-C) Emergency Services - Statewide GIS - Sheet No 76, Item #6
23.5.7	Shall route any type of 9-1-1 traffic to the appropriate PSAP based on geospatial data.	Yes	NGA 911, LLC (U-7347-C) Emergency Services - Statewide GIS - Sheet No 76, Item #7

23.5.8	Shall provide on demand reports, performance measurements, discrepancy tracking, for GIS quality assurance and system status.	Yes	NGA 911, LLC (U-7347-C) Emergency Services - Statewide GIS - Sheet No 76, Item #8
23.5.9	Shall provide a dashboard or other tool to view system operation and data metrics.	Yes	NGA 911, LLC (U-7347-C) Emergency Services - Statewide GIS - Sheet No 76, Item #9
23.5.10	Shall provide outage notifications to CA 9-1-1 Branch.	Yes	NGA 911, LLC (U-7347-C) Emergency Services - Statewide GIS - Sheet No 76, Item #10
23.5.11	Shall provide outage notifications with duration to system monitoring dashboard.	Yes	NGA 911, LLC (U-7347-C) Emergency Services - Statewide GIS - Sheet No 76, Item #11

CA NG911 - Region Cost Summary

Length of Contract in Years: 5

CA NG 911 Region Cost Summary Table		Total NRC Costs	Total MRC 5 Years
	Total Evaluated Non-Recurring Costs (NRC) - NG9-1-1 Trunks	\$ 117,000.00	
	Total Evaluated Cost (120 month of MRC) - NG9-1-1Trunks		\$ 15,210,000.00
	Total Evaluated Non-Recurring Costs (NRC) - Aggregation	\$ 775,000.00	
	Total Evaluated Cost (120 month of MRC) - Aggregation		\$ 3,027,000.00
	Total Evaluated Non-Recurring Costs (NRC) - Region	\$ 2,257,000.00	
	Total Evaluated Cost (120 month of MRC) - Region		\$ 31,170,000.00
	Total Evaluated 1st year Labor Rate	\$ 1,725,000.00	
	NRC Total	\$ 4,874,000.00	
	120 month MRC Total		\$ 49,407,000.00
GRAND TOTAL FOR CONTRACT AWARD			\$ 54,281,000.00

Estimated Annual Cost of NG9-1-1 Region Contract \$ 9,881,400.00

CA NG 911 Region Specific Costs - All implementation/on going maintenance is all inclusive of costs

A	B	C	D	E	F	G	H	I
Line Item #	Feature Name	Feature Description	Quantity	Unit of Measure	Monthly Recurring Charge	Non-Recurring (One Time Charge)	Total Extended Annual Cost (D*Fx12mo)	Total Extended NRC Costs
22.11.1	NRC New Technology PSAP Integration (est. 50hrs/each 110PSAPs)	Per the Requirements in Exhibit 23	5,500	Per Hour	-	150.0000	\$ -	\$ 825,000.00
22.11.2	NG9-1-1 Training	Per SOW Requirements	6,000	Per Hour		150.0000		\$ 900,000.00
	MRC Annual 12 month Total						\$ -	
	NRC Total							\$ 1,725,000.00

The rates for years 1 through 10 are fixed. Estimating for the Regoin to have 50hrs at each PSAP per year = 5,500 hours

CA NG 911 Prime Aggregation Costs - Each Cost Element lists the Technical Requirements from Exhibit 21 that shall be included with each cost element

A	B	C	D
Cost Element	Technical Requirements Included in Cost Element.	Feature Description	Technical Elements Included in each Cost Element
22.8.1	NG 9-1-1 One-time Circuit Install & Test	Service testing	23.4.2, 23.4.5, 23.4.6
22.8.2	NG 9-1-1 Alternate Technology to Support Diverse Path	NG 9-1-1 Diverse Path	23.4.2, 23.4.5, 23.4.6
22.8.3	NG 9-1-1 Monthly Circuit Cost (1 Mbps)	NG 9-1-1 Trunk - 1 Mbps	23.4.2, 23.4.5, 23.4.6
22.8.4	NG 9-1-1 Monthly Circuit Cost (10 Mbps)	NG 9-1-1 Trunk - 10 Mbps	23.4.2, 23.4.4, 23.4.5, 23.4.6
22.8.5	NG 9-1-1 Monthly Circuit Cost (100 Mbps)	NG 9-1-1 Trunk - 100 Mbps	23.4.2, 23.4.5, 23.4.6
22.8.6	NG 9-1-1 Monthly Circuit Cost (1000 Mbps)	NG 9-1-1 Trunk - 1000 Mbps	23.4.2, 23.4.5, 23.4.6
22.8.7	NG 9-1-1 Trunk SD WAN service	SD WAN Service	23.4.10, 23.4.11, 23.4.12
22.8.8	NG 9-1-1 Trunk Data Center Cross Connects	Non-Bidder owned Data Center cross connections	Dependent on Solution
22.9.1	NRC Project Initiation and Design	Aggregation Service Initialization	Paid through Contract
22.9.2	OSP Integration NRC	Upon successful OSP integration into	23.3.5
22.9.3	Region Aggregation	Recurring cost for Statewide	23.1.14, 23.2.8, 23.3.2, 23.3.3, 23.3.6,
22.9.4	Point of Interconnection	Interconnection between disparate technologies such as originating carrier network and NG9-1-1 network	23.1.14, 23.2.8, 23.3.4
22.10.1	NGCS per NENA i3 requirements and standards	NGCS to include all functional elements	23.1.2, 23.1.3, 23.1.5, 23.1.6, 23.1.7, 23.1.8, 23.1.9, 23.1.10, 23.1.11, 23.1.12, 23.1.13, 23.1.18, 23.1.19, 23.1.20, 23.1.21, 23.1.22, 23.2.1, 23.2.2, 23.2.8, 23.2.9 through 23.2.13, 23.2.15, 23.2.23, 23.5.2, 23.5.7
22.10.2	LPG - Legacy PSAP Gateway	Interface service to the PSAP	23.1.13, 23.2.8
22.10.3	Prime Interoperability Connection (ESInet to ESInet)	ESInet to ESInet connection	23.1.4, 23.1.16, 23.1.17, 23.2.25, 23.2.26, 23.3.7
22.10.4	Regional Integration at PSAP	Implementation Services at each PSAP	23.1.13, 23.1.14
22.10.5	System Monitoring and Dashboard Interface	Statewide System monitoring	23.2.14, 23.2.16, 23.2.17, 23.2.18, 23.2.19, 23.2.22, 23.3.9, 23.4.3, 23.4.7, 23.4.9, 23.5.9, 23.5.11
22.10.6	Outage Reporting	Automated system for outage reporting	23.1.23, 23.2.17, 23.2.24, 23.3.8, 23.4.8, 23.4.9, 23.5.10, 23.5.11
22.10.7	NRC Project Initiation and Design	Project Initialization for NGCS	Paid through Contract
22.10.8	NRC New Technology Region Integration	Technologies beyond standard updates	Based on New Technologies
22.10.9	NRC New Technology PSAP Integration	Integration service at PSAP	Based on New Technologies
22.10.10	GIS Regional synchronization -Update GIS from Prime	Manage GIS Updates	23.5.1, 23.5.3, 23.5.4, 23.5.5, 23.5.6, 23.5.8,
22.10.11	Call Data Record Management System / 9-1-1 Traffic Logging	Meta data and i3 logging	23.2.3, 23.2.4, 23.2.5, 23.2.5, 23.2.6, 23.2.7, 23.2.20, 23.2.21
22.10.14	LVF Synchronization	Synch LVF and compare with Prime	23.1.15, 23.2.27